Nuclear Plant Journal

*An International Publication
Published in the United States*

*Product & Service
Directory- 2009 Issue*

**November-December 2008
Volume 26 No. 6**

ISSN: 0892-2055

Grand Gulf, USA

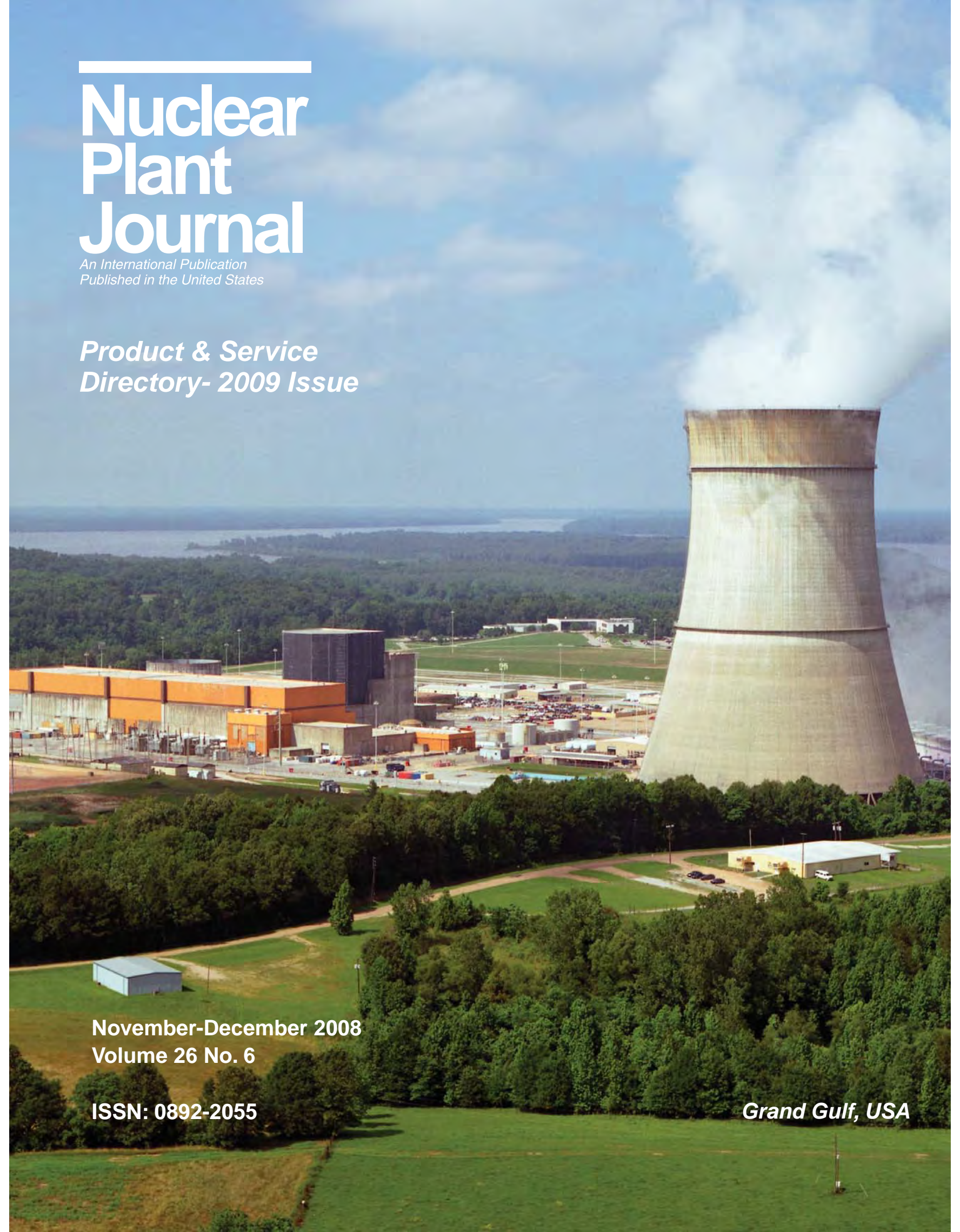

KEY QUESTION FOR THE FUTURE

How will you achieve
zero fuel failures by 2010?



With AREVA NP's Zero Tolerance for Failure Culture.

AREVA is committed to delivering reliable, failure-free fuel performance. AREVA's CE HTP Fuel Assembly designs have continued to provide the solution to Grid-To-Rod Fretting failures in the CE-designed nuclear plant fleet. The CE HTP Fuel Assembly is just one example of our continued investment in equipment, design, processes, and our people to cultivate and fortify our Zero Tolerance for Failure culture. A culture defined by seven key aspects which are firmly aligned with INPO's seven attributes of the zero fuel failures by 2010 guideline. www.us.aveva.com

Learn more about our commitment to zero fuel failures at www.us.aveva-np.com/fuel.



© 2008 AREVA NP Inc.

A
AREVA
PURE ENERGY

ZETEC

More Experience, More Resources and The Most Advanced Technology To Support Plant Inspections



Zetec is the World-leader in providing nondestructive (NDE) inspection solutions for the power generating industry based on integrated multi-method technologies – eddy current, ultrasonic, remote field and magnetic flux leakage.

The company offers the complete NDE solution including a line of turn-key systems, instrumentation, software products, supplies, calibration, repair, training and inspection services, all offered world-wide. In addition, our customers bring Zetec hundreds of new nondestructive testing challenges. Zetec focuses on these customer applications to provide complete solutions as well as leadership for innovation and best practices in NDE inspections. Zetec has an accomplished team of industry and technical experts – application engineers, probe designers, machinists, and assemblers – to meet those challenges.

www.ZETEC.com



Snoqualmie, Washington - Deep River, Ontario - Quebec City, Quebec - Paris, France - Seoul, Korea - Beijing, China



AREVA EPR now under construction in France.



Your Partner for Nuclear Power

UniStar is charting a new course to America's energy future with a fleet of AREVA's advanced design U.S. EPR nuclear power plants. UniStar's business model of flexible ownership and operations provides certainty of energy when and where you need it.

To find out more about UniStar, call 410.470.4400 or visit www.unistarnuclear.com.

For information on AREVA's U.S. EPR, visit www.us.aveva-np.com.

For monthly photo updates of construction progress, send your e-mail address to info@unistarnuclear.com.



Nuclear Plant Journal

Product & Service Directory 2009



Now in its 26th Year of Publication

Table of Contents

November-December 2008
Volume 26 No. 6

Directory Directions6, 55
 List of Advertisers8
 Products and Services10
 Corporate Capabilities90
 Corporate Capabilities Participants...107
 Suppliers109
 Grand Gulf Profile.....117

Please visit
www.NPJOnline.com

Journal Services

2009 Editorial Schedule 79
 2010 Directory 40
 Web Directory..... 108

The Cover

Grand Gulf Nuclear Station has a boiling water reactor designed by GE Hitachi Nuclear and has a net generating capacity of 1210 megawatts. It is located in Mississippi. See page 117 for a plant profile of Grand Gulf Nuclear Station.

Photo courtesy of Entergy.

Mailing Identification Statement

Nuclear Plant Journal (ISSN 0892-2055) is published bimonthly in February, April, June, August, October and December by EQES, Inc., 799 Roosevelt Road, Building 6, Suite 208, Glen Ellyn, IL 60137-5925. The Journal is available cost-free to qualified readers worldwide. The subscription rate for non-qualified readers is \$150.00 per year. The cost for non-qualified, non-U.S. readers is \$180.00. Payment may be made by American Express®, Master Card®, VISA® or check and should accompany the order. Checks not drawn on a United States bank should include an additional \$45.00 service fee. All inquiries should be addressed to *Nuclear Plant Journal*, 799 Roosevelt Road, Building 6, Suite 208, Glen Ellyn, IL 60137-5925; Phone: (630) 858-6161 ext. 103; Fax: (630) 858-8787. Periodicals (permit number 000-739) postage paid at the Glen Ellyn, IL 60137 and additional mailing offices. POSTMASTER: Send address changes to *Nuclear Plant Journal* (EQES, Inc.), 799 Roosevelt Road, Building 6, Suite 208, Glen Ellyn, IL 60137-5925.

Circulation Statistics

Total:	12,000
Utilities:	4,600

© Copyright 2008 by EQES, Inc.
Nuclear Plant Journal is a registered trademark of EQES, Inc. Printed in USA.

Staff

Senior Publisher & Editor
Newal K. Agnihotri

Publisher & Sales Manager
Anu Agnihotri

Editorial & Marketing Assistant
Michelle Yong

Administrative Assistant
QingQing Zhu



Directory Directions

Features

The Directory is a source of information on resources for over 3,000 products and services related to the nuclear power industry. The information included in the Directory was submitted by approximately 300 suppliers worldwide in October and November 2008.

The Products & Services section includes listings of available current products and services with the names of the related suppliers. Items listed in the Directory are related to the nuclear power industry only. Therefore, the words “nuclear” or “nuclear power” have been dropped from certain product and service terms.

The modified noun approach has been used for several terms. For example, Corrosion Monitoring Software has

been listed as “Software: Corrosion Monitoring.” “Airborne Radioactivity Monitoring Systems” has been listed as “Monitoring Systems: Airborne Radioactivity.”

Each supplier’s listing in the Suppliers section includes complete contact information.

Telephone numbers outside of the United States are listed as submitted by the Directory participants. The caller may need to add the proper country and city codes to make the telephone or fax number complete.

The bullets before individual suppliers in the Products & Services section and in the Suppliers section denote an advertiser in the Directory. The page number of each advertisement is shown in the List of Advertis-

ers on Page 8 and also in the Suppliers section immediately following the supplier’s contact information.

Corporate Capabilities

The Corporate Capabilities section lists products and services of organizations in one central location. Supplier contact information is also provided in this section. A “§” symbol before the contact information in the Suppliers section indicates that the organization has a listing in the Corporate Capabilities section. A list of Corporate Capabilities participants is provided on Page 107.

Phone: (630) 858-6161, ext. 106
Fax: (630) 858-8787
E-mail: NPJ@goinfo.com
Web Site: www.NPJOnline.com



HEAVY LIFT RIGGING • TRANSPORTATION • ENGINEERING



- Next generation nuclear power plant construction
- Generator Stator Replacement
- Nuclear decommissioning projects
- Reactor vessel head replacement
- Steam generator replacement
- Specialized heavy transportation
- Transport and rigging engineering
- Marine operations
- Single failure proof hoist supply

For more information, please visit our web site at: www.bigge.com

Phone: 510-638-8100 • Fax: 510-639-4053 • Email: gknopf@bigge.com (Gedge Knopf)

©2008 Thermo Fisher Scientific Inc. All rights reserved. All trademarks are the property of Thermo Fisher Scientific Inc. and its subsidiaries.

Got Radiation? See what you've been missing

The Thermo Scientific MegaRAD series of radiation hardened CID imaging cameras are capable of operating in high dose environments and provide excellent image quality to total dose levels over 100 times the tolerance of conventional solid state cameras.

- Color and Monochrome imaging to beyond 3 MegaRAD
- High resolution CID imager technology
- Small remote detachable head

Look closer at the Thermo Scientific line of radiation hardened cameras. Visit www.thermo.com/cidtec or contact us today about new innovative imaging products.

Tel: 1-315-451-9410 • Email: sales.cidtec@thermo.com



The world's only color rad hard camera

Innovative Preamp per pixel CID design allows high radiation tolerance and excellent image quality even in low light conditions.

List of Advertisers

Page Advertiser

44	AAF
11	AECL CANDU Services
48	Aerofin Corporation
85	Alstom Power Systems
33	American Crane & Equipment Corporation
14	American Tank & Fabricating
67	ANSALDO NUCLEARE, Division of Ansaldo Energia SpA
2	AREVA NP, Inc.
81	Babcock & Wilcox Canada Ltd.
6	Bigge Power Constructors
25	Black & Veatch
13	Canberra Industries, Inc.
63	Ceradyne
57	Climax Portable Machine Tools, Inc.
87	Copes-Vulcan
120	Curtiss-Wright Flow Control Corporation
15	Data Systems & Solutions
59	Day & Zimmermann Power Services
64	Divesco, Inc.
18-19	EXCEL Services Corporation
68-69	Flowserve
78	Frontier Technology Corporation
79	G. D. Barri & Associates, Inc.
9	GE Hitachi Nuclear Energy
37	General Atomics-Electronic Systems, Inc.
58	Hilman Rollers
10	Hi-Q Environmental Products Company
21	Holtec International
41	Joseph Oat Corporation
51	Kinectrics Inc.
61	LND, Inc.
61	Ludlum Measurements, Inc.
20	Meggitt Safety Systems
17	Mirion Technologies, Inc.

Page Advertiser

47	Mohawk Industrial & Nuclear Supply, Inc.
79	National Enrichment Facility
78	NPTS, Inc.
23	Nuclear Logistics Inc.
49	NUCON International
76	Pawling Engineered Products
80	Performance Contracting Inc. (PCI)
16	Power House Tool, Inc.
26	Proto-Power Corporation
62	Schulz Electric Company
75	Seal Master
53	Siemens Power Generation
32	SSM Industries
73	Studsvik, Inc.
54	Technology for Energy Corporation (TEC)
77	tecnatom, s.a.
29	The Shaw Group Inc., Nuclear Power Division
7	Thermo Fisher Scientific, Scientific Instruments Division CIDTEC Cameras & Imagers
65	Tri Tool Inc.
45	Trust Manufacturing
56	Underwater Construction Corporation
4	UniStar Nuclear Energy
22	UniTech Services Group
34	UniTech Services Group
47	UniTech Services Group
43	Urenco Enrichment Company Ltd.
72	Westerman Nuclear
22	Western Chemical International Inc.
119	Westinghouse Electric Company LLC
70	WM Symposia, Inc.
39	WorleyParsons
3	Zetec, Inc.



All advertiser web sites are listed on page 108. Complete advertiser contact information, including e-mail and web site addresses, is also provided in the Suppliers section starting on page 109.

GE Hitachi
Nuclear Energy

Puzzle...Solution!

Whether stocking a part, planning an outage or dealing with an emergent issue, you must be able to rely on your original equipment manufacturer to deliver high quality parts when you need them.

We are redesigning our parts business to support these needs and our goal is simple—to provide you with an exceptional customer experience.

For reliable nuclear solutions, email nuclearparts@ge.com.

Our Nuclear Parts business puts the pieces together to offer a comprehensive portfolio of parts for electronic, electrical, and mechanical plant needs.

GEH Nuclear Parts
Wilmington, NC USA
+1-800-425-8108
Nuclearparts@ge.com



HITACHI

Products & Services

3D Laser Scanning of Facilities
 • Atomic Energy of Canada Limited

Absorbents

Homeland-Defense 4 U, Inc.
 JRM Chemical, Inc.

Absorbers

JRM Chemical, Inc.

Absorbers: Charcoal

Ionex Research Corp.

Accelerometers

C.J. Enterprises Inc., Div. of C.J. Instruments, Inc

Access Control Systems

• Mirion Technologies
 RTC Associates, Inc.

Access Processing Software

Scientech

Accumulators

Precision Custom Components, LLC

Actuators

• Copes-Vulcan, An SPX Brand
 E.H. Wachs Co.
 Enertech
 Flowserve Flow Control Division
 • Seal Master Corporation
 Serapid
 • SSM Industries, Inc.
 Wyle Laboratories, Inc.

Adsorbents: Radioiodine

• NUCON International, Inc.

Adsorbents: Radioiodine, Laboratory Testing

• NUCON International, Inc.

Adsorber Cells: Charcoal

• AAF International
 • NUCON International, Inc.

Absorbers

• AAF International
 • NUCON International, Inc.

Aerosol Testing Materials

• NUCON International, Inc.

Aging Management

Advent Engineering Services, Inc.
 • Data Systems & Solutions SAS
 Enercon Services, Inc.
 Wyle Laboratories, Inc.

Air Balancing

• NUCON International, Inc.

Air Conditioning: Packaged

• Nuclear Logistics, Inc.
 • SSM Industries, Inc.

Air Conditioning: Split

• Nuclear Logistics, Inc.

Air Cylinders Refill System

American Airworks

Air Dryers

• Nuclear Logistics, Inc.

Air Filtration Units

• AAF International
 Bartlett Holdings, Inc.
 Ionex Research Corp.

• Nuclear Logistics, Inc.
 • NUCON International, Inc.
 • SSM Industries, Inc.

Air Handling Units

• AAF International
 • Nuclear Logistics, Inc.
 • SSM Industries, Inc.
 Wyle Laboratories, Inc.

Air Lock Services

• Seal Master Corporation
 Trentec, Inc.

Air Monitoring Systems: Containment

• Meggitt Safety Systems

Air Samplers

Draeger Safety, Inc.
 • HI-Q Environmental Products Company
 • Mirion Technologies
 Staplex-Air Sampler Division

Air Samplers: Personal

• HI-Q Environmental Products Company

Air Sampling Systems

• HI-Q Environmental Products Company
 • Mirion Technologies

ALARA Management Services

Bartlett Holdings, Inc.

Alarm Monitoring Panels

• Data Systems & Solutions SAS

Alarm Monitoring System

• Data Systems & Solutions SAS
 • Ludlum Measurements, Inc.

HI-Q ENVIRONMENTAL PRODUCTS COMPANY
Air Sampling Equipment, Systems & Accessories

QMI REGISTERED ISO 9001 Certified Quality Counts!

Continuous Duty High & Low Volume Air Samplers

Filter Holders and Filter Media

Complete Stack & Fume Hood Sampling Systems

Air Flow Calibrators

Mobile Cart Air Samplers

Our product line also includes:

- Calibration & Repair Services
- Silver Zeolite Cartridges
- Filter Holders (In-Line, Open Faced, Combination)
- Filter Paper
- Outdoor Ambient Air Samplers & Shelters
- Custom Product & System Design
- TEDA Impregnated Carbon Cartridges

7386 Trade Street
 San Diego, CA 92121
 Phone: 858-549-2820
 Fax: 858-549-9657
 Email: info@HI-Q.net
 Internet: www.HI-Q.net

Historical NPJ Cover

Volume 1 No. 2
 An EGES Publication
 March-April 1983

Nuclear Plant Safety

March-April 1983
 Volume 1, Issue 2

St. Lucie nuclear power plant.
 FP&L Company



You expect nothing less



**Reliability. Safety. Performance. Responsiveness.
And a CANDU Services team that's always "on".**

At AECL CANDU Services, we understand your high expectations, and can anticipate your needs. Find out how our CANDU nuclear technology expertise, advanced engineering tools and dedicated team can help you optimize your CANDU plant performance, increase safety and reduce costs.

 **CANDU[®] Services**



www.aecl.ca

- Mirion Technologies
Scientech
- **Alarm System Sensors**
- Data Systems & Solutions SAS
- **Alarm Systems**
- Data Systems & Solutions SAS
- **Alarms: Dose**
- Mirion Technologies
- **Alarms: Electronic Modules**
Acromag, Inc.
- Data Systems & Solutions SAS
Scientech
- **Alarms: Rate**
- Mirion Technologies
- **Alarms: Safety-Related**
- Data Systems & Solutions SAS
- Mirion Technologies
Nutherm International, Inc.
Scientech
- **Ammeters**
Wyle Laboratories, Inc.
- **Amplifiers**
- Data Systems & Solutions SAS
- **Analysis: 10 CFR 61 Compliance**
Eberline Services Inc.
- **Analysis: Bioassay**
Eberline Services Inc.
- **Analysis: Chemical**
ATI Wah Chang
EXPONENT
Herguth Laboratories
- Kinectrics Incorporated
Scientech
- **Analysis: Criticality**
CTR Technical Services, Inc.
- Data Systems & Solutions SAS
- Holtec International
- Joseph Oat Corporation
Scientech
WMG, Inc.
- **Analysis: Dynamic**
ATI Wah Chang
- Babcock & Wilcox Canada
EXPONENT
- Holtec International
- Nuclear Logistics, Inc.
Sargent & Lundy
WMG, Inc.
Wyle Laboratories, Inc.
- **Analysis: Elemental, Isotopic**
ATI Wah Chang
Mass Spec Services
Thermo Scientific, Niton Analyzers
- **Analysis: Engineering**
- American Crane & Equipment Corp.
- Atomic Energy of Canada Limited
CTR Technical Services, Inc.
Enercon Services, Inc.
- EXCEL Services Corporation
EXPONENT
- Joseph Oat Corporation
- Proto-Power Corporation
Sargent & Lundy
Scientech
- Siemens Energy, Inc.
- Tecnatom, S.A.
- The Shaw Group Inc., Nuclear Power Division
Wyle Laboratories, Inc.
- **Analysis: Environmental**
ATI Wah Chang
- Canberra Industries, Inc.
Eberline Services Inc.
Enercon Services, Inc.
- EXCEL Services Corporation
EXPONENT
- Nuclear Logistics, Inc.
Sargent & Lundy
- The Shaw Group Inc., Nuclear Power Division
- **Analysis: Finite Element**
- Babcock & Wilcox Canada
BW/IP International, Inc.

- Design Engineering Analysis Corporation
Enercon Services, Inc.
EXPONENT
- Holtec International
Howden UK Ltd
- Nuclear Logistics, Inc.
- Proto-Power Corporation
Scientech
Trentec, Inc.
WMG, Inc.
Wyle Laboratories, Inc.
- **Analysis: Heat Transfer**
Enercon Services, Inc.
EXPONENT
- Holtec International
- Joseph Oat Corporation
- Proto-Power Corporation
- **Analysis: Hydraulic**
Enercon Services, Inc.
EXPONENT
Fortum Nuclear Services Ltd.
- Holtec International
- Proto-Power Corporation
Sargent & Lundy
- **Analysis: Material Identification**
ATI Wah Chang
EXPONENT
- Kinectrics Incorporated
Laboratory Services
Scientech
The M&P Lab
- Trust Manufacturing
Wyle Laboratories, Inc.
- **Analysis: Mixed Waste**
- Canberra Industries, Inc.
Eberline Services Inc.
- Kinectrics Incorporated
- **Analysis: Modal**
BW/IP International, Inc.
Wyle Laboratories, Inc.
- **Analysis: Neutron Activity**
- Mirion Technologies
TransWare Enterprises Inc.
WMG, Inc.
- **Analysis: Polymer**
EXPONENT
- Kinectrics Incorporated
- **Analysis: Project**
Enercon Services, Inc.
- EXCEL Services Corporation
- **Analysis: Radioactive Gas**
- Kinectrics Incorporated
- NUCON International, Inc.
- **Analysis: Reactor Physics**
- Atomic Energy of Canada Limited
CTR Technical Services, Inc.
- Data Systems & Solutions SAS
- EXCEL Services Corporation
TransWare Enterprises Inc.
- **Analysis: Reliability**
- Data Systems & Solutions SAS
Enercon Services, Inc.
- EXCEL Services Corporation
EXPONENT
Sargent & Lundy
Scientech
Wyle Laboratories, Inc.
- **Analysis: Risk**
Atlantic Nuclear Services Ltd.
Enercon Services, Inc.
- EXCEL Services Corporation
EXPONENT
S.E. Logan and Associates, Inc.
Sargent & Lundy
Scientech
Serdula Systems Ltd.
- **Analysis: Root Cause**
BW/IP International, Inc.
Enercon Services, Inc.
- EXCEL Services Corporation
EXPONENT
Herguth Laboratories
- Kinectrics Incorporated

- O'Donnell Consulting Engineers, Inc.
- Proto-Power Corporation
Sargent & Lundy
- Siemens Energy, Inc.
Wyle Laboratories, Inc.
- **Analysis: Safety**
CTR Technical Services, Inc.
- Data Systems & Solutions SAS
Enercon Services, Inc.
- EXCEL Services Corporation
- Proto-Power Corporation
Scientech
Serdula Systems Ltd.
- The Shaw Group Inc., Nuclear Power Division
VTT Technical Research Centre of Finland
- **Analysis: Severe Accident**
Enercon Services, Inc.
Sargent & Lundy
Scientech
- The Shaw Group Inc., Nuclear Power Division
- **Analysis: Static**
EXPONENT
- **Analysis: Stress**
ATI Wah Chang
- Atomic Energy of Canada Limited
- Babcock & Wilcox Canada
Enercon Services, Inc.
EXPONENT
- Holtec International
O'Donnell Consulting Engineers, Inc.
- Proto-Power Corporation
Sargent & Lundy
- The Shaw Group Inc., Nuclear Power Division
WMG, Inc.
Wyle Laboratories, Inc.
- **Analysis: Structural**
- American Crane & Equipment Corp.
- Babcock & Wilcox Canada
Enercon Services, Inc.
EXPONENT
- Holtec International
O'Donnell Consulting Engineers, Inc.
- Proto-Power Corporation
Sargent & Lundy
WMG, Inc.
- **Analysis: Support**
Enercon Services, Inc.
- Proto-Power Corporation
- **Analysis: Task**
Enercon Services, Inc.
- EXCEL Services Corporation
- **Analysis: Thermal**
ATI Wah Chang
- Babcock & Wilcox Canada
Enercon Services, Inc.
EXPONENT
- Holtec International
- Joseph Oat Corporation
O'Donnell Consulting Engineers, Inc.
- Performance Contracting Inc. (PCI)
- Proto-Power Corporation
Sargent & Lundy
Scientech
- **Analysis: Vibration**
- Babcock & Wilcox Canada
Enercon Services, Inc.
EXPONENT
- Holtec International
Howden UK Ltd
- Joseph Oat Corporation
O'Donnell Consulting Engineers, Inc.
- Proto-Power Corporation
- Schulz Electric Company
- Siemens Energy, Inc.
WMG, Inc.
Wyle Laboratories, Inc.
- **Analysis: Waste**
ATI Wah Chang
- Canberra Industries, Inc.
Eberline Services Inc.
Sargent & Lundy
WMG, Inc.



Meet the newest members of the CANBERRA Contamination Monitor Family

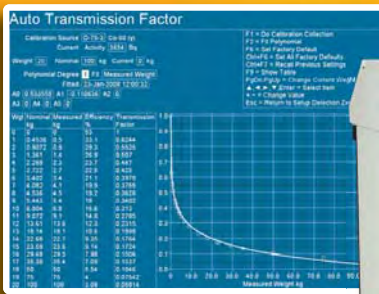

Auto Transmission Factor
Calibration Screen

The Cronos-11



The Cronos-4

The Cronos Gamma Object/Tool Monitors

CANBERRA is pleased to announce the addition of the Cronos-4 and Cronos-11 Gamma Object/Tool Monitors to our suite of advanced personnel contamination monitors. The Cronos monitors join our industry standard Argos™ and GEM™ Whole Body Monitors and Sirius™ Hand and Foot Monitors. Built on our established GEM Gamma Exit Monitor technology and with input from a wide variety of our customers, Cronos is the monitor you need in your facility for high through-put, durability and ease of operation.

Both Cronos models have high sample capacity to accommodate larger items (or a larger number of items) than typical units in use today. The Cronos-4 has a 129-liter internal volume (twice that of other units), and the Cronos-11 has a volume two and a half times larger than the Cronos-4 at 325 liters.

With six large plastic detectors surrounding the sample on all sides, both Cronos models offer minimum detectable activities (MDAs) comparable to much smaller units as well as a uniform efficiency response.

Other standard Cronos features for long life, optimum performance and simple installation/use include:

- > Lead shielding - 25 mm (1 in.) – on all sides and an option for another 25 mm of lead shielding
- > All shielding in removable ingots for ease of installation and safe transport
- > Heavy duty casters with self-leveling feet and integrated fork lift channels for easy placement
- > Sturdy hinges with truss and roller bearings on doors
- > USB®, Ethernet and parallel interfaces
- > Single and dual door (pass-through) operation
- > Built-in weighing scale, up to 100 kg, with removable scale tray for cleaning
- > Use of same software for operation and reports as in Argos, GEM and Sirius monitors to simplify training
- > Software includes capability for calibration versus weight and user-definable transmission correction factors for specific activity determination
- > Compatible with optional CRemote Centralized Remote Control Software for system management from anywhere on the network

You spoke. We listened. Now you can take advantage of the results! Contact CANBERRA to learn more about the Cronos-4 and Cronos-11 Gamma Object/Tool Monitors.

www.canberra.com

Canberra Industries, Inc.
800 Research Parkway – Meriden, CT 06450 U.S.A.
Tel: (203) 238-2351 – Toll free: 1-800-243-4422
Fax: (203) 235-1347

The CANBERRA personnel contamination monitor family.

GEM™ Gamma Exit Monitor



Sirius™ Hand and Foot Monitor



Argos™ Whole Body Monitor

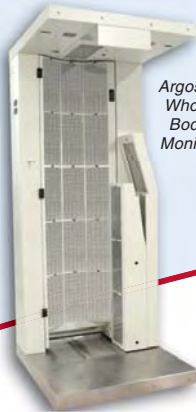

CANBERRA

Analytical Services

- Atomic Energy of Canada Limited
- Enercon Services, Inc.
- EXCEL Services Corporation
- Kinectrics Incorporated
- O'Donnell Consulting Engineers, Inc.

Analyzers: Multichannel

- Biodex Medical Systems
- Canberra Industries, Inc.
- Mirion Technologies

Analyzers: Power Demand and Harmonics

- Siemens Energy, Inc

Annunciators

- Stacosystems
- Trentec, Inc.

Anti-friction Bearings: Safety-Related

- Schulz Electric Company
- Scientech

Asbestos Abatement Services

- Fuel Tank Maintenance Company LLC

ASME Certificate Holder

- AT&F Nuclear, Inc, Division of American Tank and Fabricating

Fabricating

- ATI Wah Chang
- Copes-Vulcan, An SPX Brand Energy & Process Corporation
- Enertech
- Nuclear Logistics, Inc.
- NUCON International, Inc.
- Precision Custom Components, LLC
- The Shaw Group Inc., Nuclear Power Division
- Tioga Pipe Supply Company Inc.
- Valcor Engineering Corporation
- Westerman Nuclear

Assemblies: Electrical

- Data Systems & Solutions SAS
- Nuclear Logistics, Inc.

Trentec, Inc.

- Wyle Laboratories, Inc.

Assemblies: Printed Circuit

- Data Systems & Solutions SAS
- Nuclear Logistics, Inc.
- Scientech

Assessment: Plant Condition

- Black & Veatch
- EXCEL Services Corporation
- RMD Instrument Corp
- S.M. Stoller Corp.
- Sargent & Lundy
- Siemens Energy, Inc

Assessments: Operations Experience

- EXCEL Services Corporation
- S.M. Stoller Corp.
- Scientech
- Siemens Energy, Inc

Assessments: Program

- Black & Veatch
- EXCEL Services Corporation
- EXPONENT
- Siemens Energy, Inc

Asset Tracking Systems

- Black & Veatch

Audit

- Black & Veatch
- EXCEL Services Corporation
- S.M. Stoller Corp.

Audit Support: Fitness-for-Duty

- American Triex, Inc.

Audit Support: Program

- EXCEL Services Corporation

Audit Support: Technical Specialist

- American Triex, Inc.
- EXCEL Services Corporation
- Sargent & Lundy

Auditing: Environmental

- EXCEL Services Corporation
- S.M. Stoller Corp.

Audits: Quality

- Advent Engineering Services, Inc.
- EXCEL Services Corporation
- National Inspection & Consultants, Inc.
- S.M. Stoller Corp.
- Sargent & Lundy
- Sonic Systems International, Inc.
- The Shaw Group Inc., Nuclear Power Division

Availability Improvements

- Black & Veatch
- Data Systems & Solutions SAS
- EXCEL Services Corporation
- Sargent & Lundy
- Siemens Energy, Inc
- The Shaw Group Inc., Nuclear Power Division

Babbitt Bearing: Repair, Safety-Related

- Schulz Electric Company

Bags

- Apco Extruders Inc.
- Euclid Garment Manufacturing Company
- LANCS Industries, Inc.
- Reef Industries, Inc.
- Seal Master Corporation
- UniTech Services Group, Inc., Div. of Unifirst Corp.

Bags: Asbestos

- Apco Extruders Inc.
- Reef Industries, Inc.

Bags: Laundry

- Euclid Garment Manufacturing Company
- LANCS Industries, Inc.
- UniTech Services Group, Inc., Div. of Unifirst Corp.
- Worklon Uniforms

Balancing

- Energy Resources Group, Inc.
- Schulz Electric Company
- Siemens Energy, Inc

Bargraphs: Class 1E

- Scientech
- Trentec, Inc.

From Renaissance to Reality

It's no secret there is a rebirth of interest in nuclear technology. You should know that AT&F Nuclear has actively cultivated our nuclear fabrication experience over the years and continues to meet the demanding needs of the industry.

With over six decades of manufacturing experience, extensive facilities, and the ability to cut, form, join and machine almost any kind of metal, AT&F has the experience, the capacity and the technology to help take the nuclear power renaissance to reality.

If you're ready to take the step, we're here to make it happen.

- Reactor internals
- Structural supports
- Containment parts
- Pressure vessels and tanks
- Shell and tube heat exchangers
- Radioactive material containers
- Piping systems
- Heavy lift rigs
- Material upgrades and processing
- NIAC Audited



Visit our new website!
atfnuclear.com



AT&F Nuclear, Inc.
12314 Elmwood Avenue, Cleveland, Ohio 44111-5991
800-544-5316
info@atfnuclear.com | atfnuclear.com

a subsidiary of
American Tank & Fabricating Company



Leading edge design

Optimal plant availability

Proven safety and reliability

We bring these together

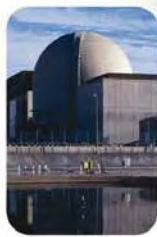

DS&S's Nuclear Safety Instrumentation & Control Systems

- Dedicated to nuclear safety I&C
- SPINLINE 3 leading edge real-time system technology
- Focus on safety, reliability and optimal availability
- 30 years experience in digital safety I&C

Contact: Data Systems & Solutions, LLC

Tel: USA: +1 (256) 705-2166 FRANCE: +33 (0) 4 76 -61-15 00
info@ds-s.com www.ds-s.com

ProtectPerformPredict



Barriers: Lead

Biodex Medical Systems
LANCS Industries, Inc.

Barriers: Security

- Black & Veatch
Enercon Services, Inc.
- Siemens Energy, Inc

Battery Chargers

- Black & Veatch
- Nuclear Logistics, Inc.
- Nutherm International, Inc.
- Scientech

Bearings: Babbitted

- Siemens Energy, Inc

Bearings: Babbitted, Repair

- Schulz Electric Company
- Siemens Energy, Inc

Bellows: Metallic

- Siemens Energy, Inc

Bills of Material Development

- Black & Veatch

Bits: Pipe Beveling Tool

E.H. Wachs Co.
Hydratight

Bits: Pipe Cutting Tool

E.H. Wachs Co.
Hydratight

Blanket Racks

LANCS Industries, Inc.

Blankets: Lead

LANCS Industries, Inc.

Blocks/Bricks: High-Density Concrete

Nuclear Shielding Supplies & Service, Inc.

Blocks/Bricks: Lead

Biodex Medical Systems
LANCS Industries, Inc.

Blowers: Ventilation

Howden UK Ltd

Nutherm International, Inc.
Wyle Laboratories, Inc.

Boilermaking

- Joseph Oat Corporation

Boilers

- Joseph Oat Corporation

Bolt Heaters

- Power House Tool, Inc.

Bolt Hole Maintenance

- Hydratight
- Siemens Energy, Inc

Bolt Tensioning Systems

- Associated Technologies
- Biach Industries, Inc.
- Scientech
- Siemens Energy, Inc
- Trust Manufacturing

Bolt Tensioning: Precision

- Scientech
- Siemens Energy, Inc
- Trust Manufacturing

Bolt Tightening: Ultrasonic

- Siemens Energy, Inc
- Trust Manufacturing

Bolting Services

- Siemens Energy, Inc
- Trust Manufacturing

Bolts

- Energy & Process Corporation
- Joseph Oat Corporation
- Niagara Fasteners Inc.
- Siemens Energy, Inc
- Trust Manufacturing

Bolts: Anchor

- Niagara Fasteners Inc.
- Siemens Energy, Inc
- Trentec, Inc.
- Trust Manufacturing

Boosters: Gas

American Airworks

Borescopes

- Intertest, Inc
- Siemens Energy, Inc

Borescopes: Flexible

- Intertest, Inc
- Siemens Energy, Inc

Borescopes: Measurement Systems

- Data Systems & Solutions SAS
- Intertest, Inc
- Siemens Energy, Inc

Borescopes: Video

Hennigan Engineering Company, Inc.
Intertest, Inc

Borescopes: Video, Long Articulating

- Intertest, Inc
- Siemens Energy, Inc

Boric Acid Recovery

Diversified Technologies Services, Inc.
Enercon Services, Inc.

Boring: Metal

- Climax Portable Machine Tools, Inc.
- Hydratight

Boron Carbide

- Ceradyne Boron Products, LLC
- Nuclear Shielding Supplies & Service, Inc.

Boron-10: Enriched

- Ceradyne Boron Products, LLC
- Mass Spec Services

Boron-11: Enriched

- Ceradyne Boron Products, LLC

Brazing Materials

- Siemens Energy, Inc

Breathing Apparatus

American Airworks

Bulkhead Penetrations: IE Qualified

- Meggitt Safety Systems

Bus: 1E Nonsegregated Phase

- Data Systems & Solutions SAS

Bus: Nonsegregated Phase

- Data Systems & Solutions SAS

Cabinets: Shielded

Biodex Medical Systems
LANCS Industries, Inc.

Cable Assemblies

- Black & Veatch
- Mirion Technologies
- Nuclear Logistics, Inc.
- Scientech

Cable Assemblies: Cont Rod Position Indicator

- Data Systems & Solutions SAS
- Mirion Technologies
- Rockbestos-Surprenant Cable Corporation
- Scientech

Cable Assemblies: Control Rod Drive Mechanism

- Mirion Technologies
- Rockbestos-Surprenant Cable Corporation
- Scientech

Cable Assemblies: Core Monitoring

- Mirion Technologies
- Rockbestos-Surprenant Cable Corporation
- Scientech

Cable Assemblies: Electronic

- Mirion Technologies
- Scientech

Cable Assemblies: Fiber Optic

- Mirion Technologies
- Scientech

Cable Assemblies: Radiation Resistant

- Mirion Technologies
- Rockbestos-Surprenant Cable Corporation
- Scientech
- Thermo Scientific, Part of Thermo Fisher Scientific, Process Instruments Div.

Cable Assemblies: Thermocouple

- Mirion Technologies
- Rockbestos-Surprenant Cable Corporation

Porta-Safe[®]
SPEED
HEATER CONTROLLER

More powerful than a locomotive

Faster Than induction

Heats 4 studs at once within 5 minutes or less

Speed Heating Applications:

- Turbine Horizontal Joints
- Boiler Feed Pumps
- Stop/Reheat Valves
- Main Steam Valves
- Loop Stop Isolation Valves
- Reactor Coolant Pumps

www.speedboltheating.com

JNT JNT TECHNICAL SERVICES INC.
85 Industrial Avenue
Little Ferry, New Jersey 07643
Phone: 201 641-2130 Fax: 201 641-2309
www.jnt-tech-serv.com

POWER[®]
HOUSE
TOOL INC.
626 Nicholson Street, Joliet, IL 60435
Phone: 815 727-6301 Fax: 815 727-4835
www.powerhousetool.com



MIRION
TECHNOLOGIES



Mirion Technologies

A Full Service Provider



Radiation tolerant imaging systems



Electrical penetrations, in-core/ex-core detectors



Active dosimeters



Radiation monitoring systems



Contamination & clearance monitors



Detection & identification

Mirion Technologies is the only radiation detection and monitoring company that delivers products and services into each stage of a Nuclear Power Plant's lifecycle. Our products have become the industry standard for reliability and quality.

Please refer to our extensive product listings under our five divisions:

- Health Physics
- Radiation Monitoring Systems
- Sensing Systems
- Dosimetry Services
- Imaging Systems

For more than 50 years we have provided mission critical products and services that conform to the most stringent regulations and qualification procedures.

Contact us today to discover what we can do for you at: www.mirion.com

Featuring the Mirion Brands



Global Dosimetry
Solutions



*Charting the course
of success...*

EXCEL

SERVICES CORPORATION
Nuclear Engineering Consulting

Vision

Passion

Innovation

Execution

In the beginning, **EXCEL's** first client services included providing plants with experienced individuals to support general operating plant licensing issues and to support the initial licensing of new power plants.

Since then, with over 23 years of service, **EXCEL** has earned the reputation of the premier company providing diverse licensing, operations, and engineering services, which has made **EXCEL** uniquely qualified to manage large, complex projects supporting both the current fleet of reactors and the proposed fleet of new reactors.

EXCEL continues to provide innovative solutions for complex operational, engineering, safety and regulatory issues, and provides insightful consultation to senior utility executives and committees striving to maintain and enhance the quality and safety of their organization. These services have proven to be extremely beneficial to the nuclear facilities and the regulatory agencies both in the U.S. and internationally as well.

This cumulative experience, expertise and knowledge ensure the development of the best quality product in a cost effective manner and in accordance with the highest standards of professional excellence.

Vision
Fueled by Passion
Created by Innovation
....with Excellence in Execution

Services

Domestic

Improved Technical Specification Conversions
Operations, Maintenance, Engineering Support
Logic System Functional Testing Evaluation
24 Month Fuel Cycle Interval Extension GI-91-04
Security Assessments
Fire Protection
Procedure Upgrade
UFSAR Upgrade
License Renewal
Power Uprate
Security Plans
Security Management
Construction Oversight
New Build Project Management Tools
Due Diligence
General Licensing Support
Steam Generator Replacement
General Part 52
Early Site Permitting
Combined Construction and Operating License
ITACC
Licensing for Fuel Enrichment Facility
Department of Energy Facilities Support
Licensing for Test Reactors both Domestic and International
Design and Licensing Basis Recovery Projects
Probability Risk Assessment and Risk Management
Nuclear Knowledge Management Consulting
Nuclear Knowledge Management Certification Course
Licensing for the Yucca Mountain Repository
Decommissioning
Environmental Qualification Evaluations
Preventive Maintenance Optimization
Reliability/Availability Studies
Environmental Report Site Evaluation
Setpoint Calculations
Fleet Setpoint Control Programs
Instrumentation Licensing

International

Technical Specification Licensing Pilot- Germany
Compliance Matrix for PBMR Project- South Africa
Regulatory Management Group Development-South Africa
Licensing and Regulatory Support- Finland, Sweden, Mexico
Technical and Regulatory Support- Canada, United Kingdom
Decommissioning and Decontamination- United Kingdom
Regulatory Initiatives-Russia, France, Bulgaria, Brazil, Argentina

11921 Rockville Pike, Suite 100
Rockville, MD 20852 USA
Telephone (301) 984-4400 - Facsimile (301) 984-7600
Web: www.excel services.com

for over 20 years

Scientech
Temp-Pro Inc.

Cable Markers
TECH Products, Inc.
Uticom Systems Inc.

Cable Systems: Appendix R
• Meggitt Safety Systems

Cable Tray Hangers
• Black & Veatch

Cable Tray Supports
• Black & Veatch

Cable: Coaxial
General Cable (Brand-Rex)
• Mirion Technologies
Rockbestos-Surprenant Cable Corporation

Cable: Control
General Cable (Brand-Rex)
Rockbestos-Surprenant Cable Corporation

Cable: Electronic
Rockbestos-Surprenant Cable Corporation

Cable: Fiber Optic
General Cable (Brand-Rex)
Uticom Systems Inc.

Cable: Flame Resistant
General Cable (Brand-Rex)
• Mirion Technologies
Rockbestos-Surprenant Cable Corporation

Cable: High-Temperature
• Mirion Technologies
Rockbestos-Surprenant Cable Corporation

Cable: Instrumentation
• Data Systems & Solutions SAS

General Cable (Brand-Rex)
• Mirion Technologies
Rockbestos-Surprenant Cable Corporation

Cable: Mineral Insulated
• Data Systems & Solutions SAS
• Mirion Technologies

Cable: Radiation Resistant
• Data Systems & Solutions SAS
General Cable (Brand-Rex)
• Mirion Technologies
Nutherm International, Inc.
Rockbestos-Surprenant Cable Corporation

Cable: Safety-Related
• Data Systems & Solutions SAS
General Cable (Brand-Rex)
• Mirion Technologies
• Nuclear Logistics, Inc.
Nutherm International, Inc.
Rockbestos-Surprenant Cable Corporation
Thermo Scientific, Part of Thermo Fisher Scientific,
Process Instruments Div.

Cable: Signal
• Data Systems & Solutions SAS
• Mirion Technologies
Rockbestos-Surprenant Cable Corporation

Cable: Switchboard
• Data Systems & Solutions SAS
General Cable (Brand-Rex)
Rockbestos-Surprenant Cable Corporation

Cable: Thermocouple
General Cable (Brand-Rex)
• Mirion Technologies
Rockbestos-Surprenant Cable Corporation

CAD
• Black & Veatch

CAD: Conversion
• Black & Veatch

Calculations: Code Sizing
• Black & Veatch
• EXCEL Services Corporation

Calibration Instruments
• HI-Q Environmental Products Company
• Power House Tool, Inc.
Radiation Safety Institute of Canada

Calibration Services
• Canberra Industries, Inc.
Enercon Services, Inc.
• HI-Q Environmental Products Company
Laboratory Services
• Ludlum Measurements, Inc.
• Mirion Technologies
• NUCON International, Inc.
Wyle Laboratories, Inc.

Calibration Standards: Eddy Current Testing
Intertest, Inc

Calibration Standards: Ultrasonic Scanning
Intertest, Inc

Calibration Systems
Wyle Laboratories, Inc.

Calibration: Radiation Monitoring Systems
• Canberra Industries, Inc.
• General Atomic Electronic Systems, Inc.
• Mirion Technologies
WM B. Johnson & Associates Inc.

Calibrators: Dosimeter
• Mirion Technologies

Calibrators: Gamma Survey Instrument
• NUCON International, Inc.
Warrington, Inc.

Calibrators: Instrument
• HI-Q Environmental Products Company
• Mirion Technologies

Calibrators: Radioisotope Dose
Biodex Medical Systems
• General Atomic Electronic Systems, Inc.

Calibrators: Survey Instrument
Warrington, Inc.

Calorimeters: Radioisotope
International Thermal Instrument Corporation

Meggitt Safety Systems

**A WINNING PARTNER
FOR THE
NUCLEAR RENAISSANCE**

CABLES AND H₂/O₂ MONITORING SYSTEMS
www.meggittsafety.com

MEGGITT
smart engineering for
extreme environments

Meggitt Safety Systems Inc
1915 Voyager Avenue
Simi Valley, CA 93063
USA

Tel: +1 (805) 584 4100

Calorimeters: Thermoelectric

International Thermal Instrument Corporation

Camera Systems: Miniature

- Intertest, Inc
Lights, Camera, Action LLC
- Mirion Technologies
R. Brooks Associates, Inc.
- Thermo Fisher Scientific, Scientific Instrument Division CIDTEC Cameras & Imagers

Camera Tubes: Radiation Hardened Television

- Lights, Camera, Action LLC
- Mirion Technologies
- Thermo Fisher Scientific, Scientific Instrument Division CIDTEC Cameras & Imagers

Cameras: Closed-Circuit Television

- Enercon Services, Inc.
Intertest, Inc
- Mirion Technologies
R. Brooks Associates, Inc.
- Thermo Fisher Scientific, Scientific Instrument Division CIDTEC Cameras & Imagers

Cameras: High-Temperature

- Intertest, Inc
- Mirion Technologies
R. Brooks Associates, Inc.

Cameras: Inspection

- Intertest, Inc
Lights, Camera, Action LLC
- Mirion Technologies
R. Brooks Associates, Inc.
- Thermo Fisher Scientific, Scientific Instrument Division CIDTEC Cameras & Imagers

Cameras: Underwater

- Intertest, Inc
Lights, Camera, Action LLC
- Mirion Technologies
R. Brooks Associates, Inc.
- Thermo Fisher Scientific, Scientific Instrument Division CIDTEC Cameras & Imagers

Carbon: Activated

- AAF International
- HI-Q Environmental Products Company
- NUCON International, Inc.
Resintech, Inc.

Carrier: Radionuclide

- Biodex Medical Systems
- **Casks: Storage**
AT&F Nuclear, Inc, Division of American Tank and Fabricating

- Babcock & Wilcox Canada
- Black & Veatch
- Holtec International
Precision Custom Components, LLC
SKODA JS a.s.
WMG, Inc.

Casks: Transport

- AT&F Nuclear, Inc, Division of American Tank and Fabricating
- Black & Veatch
- Holtec International
Precision Custom Components, LLC
WMG, Inc.

Castings

- ATI Wah Chang
- Black & Veatch
Energy & Process Corporation

Castings: Carbon Steel

- Trust Manufacturing
- **Castings: Metal**
ATI Wah Chang
- Trust Manufacturing

Castings: Stainless Steel

- Trust Manufacturing

Cavity Cleaning

- Tri Nuclear Corporation

Cavity Seal Rings

- Scientech
Trentec, Inc.

Centers: Electric Load

- Trentec, Inc.
Wyle Laboratories, Inc.

Ceramics

- Ceradyne Boron Products, LLC

Certified Nuclear Grade Equipment Cleaners

- Western Chemical International Inc.

Chamber Detectors: Air Ionization

- Mirion Technologies

Chambers: Explosion Proof

- Scientech
- **Chambers: Fission**
Data Systems & Solutions SAS
LND, Inc.
Mirion Technologies

Chambers: Gamma Ion

- Data Systems & Solutions SAS
- Mirion Technologies

Chambers: Ion

- Data Systems & Solutions SAS
- Ludlum Measurements, Inc.
Mirion Technologies

Chambers: Ionization

- Data Systems & Solutions SAS
Jordan Nuclear Company
- LND, Inc.
Mirion Technologies
Overhoff Technology Corporation

Chambers: Moveable In-Core Fission

- Data Systems & Solutions SAS
- Mirion Technologies

Chambers: Reactor Control

- Data Systems & Solutions SAS
- Mirion Technologies

Channels: BWR Fuel

- Veridiam

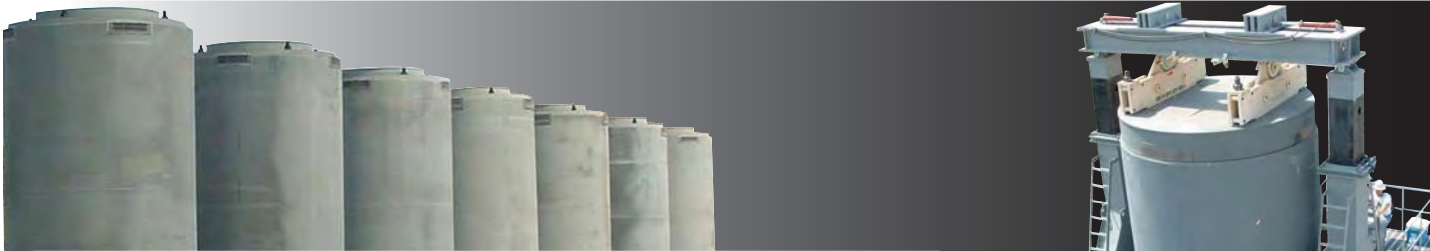

A Generation Ahead By Design

www.holtecinternational.com

- ⊗ WET & DRY STORAGE EQUIPMENT FOR SPENT NUCLEAR FUEL
- ⊗ HEAT TRANSFER EQUIPMENT FOR NUCLEAR PLANTS
- ⊗ MANUFACTURING OF SAFETY SIGNIFICANT CAPITAL EQUIPMENT
- ⊗ INNOVATIVE SOLUTIONS TO OPERATING PROBLEMS
- ⊗ ENGINEERING CONSULTING IN CRITICALITY, THERMAL HYDRAULIC, RADIOLOGICAL AND STRUCTURAL DISCIPLINES
- ⊗ SITE CONSTRUCTION & LOADING SERVICES



HOLTEC INTERNATIONAL

555 Lincoln Drive West · Marlton, NJ 08053
Ph: 856-797-0900 · Fx: 856-797-0909



Characterization: Facility • Clothing: Protective

Characterization: Facility

- Black & Veatch

Characterization: Site

- Bartlett Holdings, Inc.
- Black & Veatch
- Canberra Industries, Inc.

Charcoals: Radioiodine Laboratory Testing

- NUCON International, Inc.

Check Valve Application Review

- Black & Veatch
- Energetch
- EXPONENT
- Valcor Engineering Corporation

Chemicals: Laboratory

ATI Wah Chang

Chemistry Data Management Systems

Sciencetech

Chemistry Services

Herguth Laboratories
Sciencetech

Cherenko Viewing Devices (for nuclear safeguard)

- Atomic Energy of Canada Limited

Chillers

- AAF International
- Lytron
- Nuclear Logistics, Inc.
- Wyle Laboratories, Inc.

Chips: Coprocessor

- Nuclear Logistics, Inc.

Chips: Memory

- Nuclear Logistics, Inc.

Chromatography

Biodex Medical Systems

Circuit Breaker Maintenance

- Babcock & Wilcox Canada
- Data Systems & Solutions SAS
- Nuclear Logistics, Inc.
- Sciencetech

Circuit Breaker Retrofitting

- Black & Veatch
- Data Systems & Solutions SAS
- Nuclear Logistics, Inc.
- Sciencetech
- Trentec, Inc.
- Wyle Laboratories, Inc.

Circuit Breakers: Low-Voltage Air, Safety-Related

- Black & Veatch
- Data Systems & Solutions SAS
- Nutherm International, Inc.
- Sciencetech

Circuit Breakers: Molded Case, Safety-Related

- Black & Veatch
- Kinectrics Incorporated
- Nutherm International, Inc.
- Sciencetech

Circuit Breakers: Safety-Related

- Data Systems & Solutions SAS
- Nuclear Logistics, Inc.
- Nutherm International, Inc.
- Sciencetech
- Trentec, Inc.
- Wyle Laboratories, Inc.

Circular Multipin Connectors: IE Qualified

- Meggitt Safety Systems

Cladding

Energy & Process Corporation
Precision Custom Components, LLC

Cladding: Epoxy

Plastocor, Inc.

Claim Analysis

EXPONENT

Claim Resolution

EXPONENT

Cleaners: Electrical Equipment

- Western Chemical International Inc.

Cleaners: Environmentally Safe Equipment

- Western Chemical International Inc.

Cleaners: Mechanical Equipment

- Western Chemical International Inc.

Cleaners: RV Flange

Sciencetech

Cleaners: RV Stud

Sciencetech

Cleaners: RV Stud Hole

Sciencetech

Cleaning Equipment

Hennigan Engineering Company, Inc.
Sciencetech

- UniTech Services Group, Inc., Div. of Unifirst Corp.

Cleaning Equipment: Tube

Hennigan Engineering Company, Inc.

Cleaning Service

- UniTech Services Group, Inc., Div. of Unifirst Corp.

Cleaning: Chemical Processes

- Kinectrics Incorporated
- Siemens Energy, Inc.

Cleaning: CO2 Blast

- Schulz Electric Company
- UniTech Services Group, Inc., Div. of Unifirst Corp.

Cleaning: Heat Exchanger Tube

EXPONENT
Hennigan Engineering Company, Inc.

Cleaning: Steam

- Schulz Electric Company

Cleaning: Steam Generator

- Babcock & Wilcox Canada
- Hennigan Engineering Company, Inc.
- R. Brooks Associates, Inc.
- Siemens Energy, Inc.

Clothing: Protective

- Coastal Network, Inc.
- Euclid Garment Manufacturing Company
- LANCS Industries, Inc.
- Mohawk Industrial & Nuclear Supply, Inc.
- UniTech Services Group, Inc., Div. of Unifirst Corp.
- Worklon Uniforms

All for ONE . . .



The UniTech ONE protective clothing lease program features a single, all-inclusive cost per change out. ONE price covers everything - head to toe and cradle to grave - at far less cost than single-use. Plus, pay only for what you use.

. . . ONE for All

UniTech ONE offers the industry's most advanced, best made protective garments, including ProTech Plus, a pinnacle in protection and comfort. With great selection, excellent service, and multinational locations, UniTech ONE is truly for all.



The UniTech ONE Program

(800) 344-3824 • www.unitech.ws

XCEL IC

**NONFLAMMABLE • LEAVES NO RESIDUE • FAST EVAPORATION
SAFE FOR ALL INSULATING VARNISHES**

...for fast, effective and thorough electrical equipment cleaning during scheduled and nonscheduled plant and equipment outages, saving both time and money.

XCEL IC is environmentally compliant with all published standards.

Upon request, samples of XCEL IC will be shipped to your facility at no charge so you can make a thorough performance evaluation.

Telephone (480) 990-9487 FAX (480) 946-6174

Email: wci@westernchem.com

Consult the General Electric "Operators Manual" where XCEL IC is to be listed

> Our name says it all.

If you need it, we can design and build it.

As a company, NLI didn't start out to become an original equipment manufacturer. But it's been a natural progression, since our goal has always been to supply the most comprehensive services and equipment to the nuclear industry.

With our experience and suppliers, we are able to provide the equipment nuclear utilities need.

Whether it's standby power, electrical distribution, HVAC, or ASME III equipment and systems that are needed, we can design and build to custom parameters, quickly and efficiently, from scratch, with precise engineering and state-of-the-art technology. And then install everything seamlessly.

From wiring the smallest componentry on circuit boards to the manufacture of large hardware, NLI continues to set new standards of excellence in the trade as we rise to the challenge of helping our customers supply the world with nuclear power.



NLI
NUCLEAR LOGISTICS INC

The new acronym for OEM.

www.nuclearlogistics.com • 800.448.4124

©2008 NUCLEAR LOGISTICS INC.

Clothing: Protective, Fabrics

- Euclid Garment Manufacturing Company
- Kinectrics Incorporated
- LANCS Industries, Inc.
- UniTech Services Group, Inc., Div. of Unifirst Corp.

Coating Application Services

- Fuel Tank Maintenance Company LLC
- Hennigan Engineering Company, Inc.
- Plastocor, Inc.
- Underwater Construction Corporation

Coating: Metal

- Siemens Energy, Inc

Coating: Underwater

- Underwater Construction Corporation

Coatings

- Bartlett Holdings, Inc.
- Kinectrics Incorporated
- Scientech
- Siemens Energy, Inc

Coatings Testing

- Cygnus Instruments Inc.
- EXPONENT
- Kinectrics Incorporated

Coatings: Corrosion-Resistant

- Plastocor, Inc.
- Siemens Energy, Inc

Coils: Cooling

- AAF International
- Aerofin Corporation
- Nuclear Logistics, Inc.

Coils: Heating

- Aerofin Corporation
- Nuclear Logistics, Inc.

Colleges: Nuclear Technology Degrees

Excelsior College

Commercial-Grade Dedication

AT&F Nuclear, Inc, Division of American Tank and Fabricating

- Black & Veatch
- Enercon Services, Inc.
- Enertech
- Nuclear Logistics, Inc.
- Nutherm International, Inc.
- Sargent & Lundy
- Schulz Electric Company
- Scientech
- Trentec, Inc.
- Trust Manufacturing
- Wyle Laboratories, Inc.

Commissioning Services

- Black & Veatch
- EXCEL Services Corporation
- The Shaw Group Inc., Nuclear Power Division

Communications Accessories: Prot. Clothing

Euclid Garment Manufacturing Company

Communications Systems

- Black & Veatch
- Tecnatom, S.A.

Communications Systems: Emergency

Enercon Services, Inc.

Compactors

Container Products Corporation
S&G Enterprises, Inc.
Waste Control Systems, Inc.

Component Handling

- Siemens Energy, Inc

Compressors

- Nuclear Logistics, Inc.

Compressors: Breathing Air

American Airworks

Computer Services

STN Service Center Europe

Computer System Development

- Black & Veatch
- EXCEL Services Corporation
- Tecnatom, S.A.

Computers & Accessories

Stacosystems

Computers: Plant Process

Scientech

Computers: Replacement

- Black & Veatch

Computers: Upgrades

- Data Systems & Solutions SAS
- Sargent & Lundy
- The Shaw Group Inc., Nuclear Power Division

Concrete Cutting

- American DND Inc.
- Bluegrass Concrete Cutting, Inc.
- Cutting Edge Services Corporation
- Hennigan Engineering Company, Inc.
- Trentec, Inc.
- Underwater Construction Corporation

Concrete Repair Materials

- Kinectrics Incorporated

Concrete Services

- Nuclear Shielding Supplies & Service, Inc.
- Underwater Construction Corporation

Condenser Analysis/Inspection Services

- Hennigan Engineering Company, Inc.
- R. Brooks Associates, Inc.
- Siemens Energy, Inc
- Zetec, Inc.

Condenser Expansion Joint Replacement

Welding Services Inc.

Condenser Leak Detection

- ILD, Inc.
- Siemens Energy, Inc

Condenser Rebuilding

- Siemens Energy, Inc

Condenser Repair

Plastocor, Inc.
Welding Services Inc.

Condenser Tube Cleaning

Hennigan Engineering Company, Inc.

Condenser Tube Plugs

- Joseph Oat Corporation
- Powerfect

Condensers

- Black & Veatch
- Holtec International
- Joseph Oat Corporation
- Nuclear Logistics, Inc.
- Siemens Energy, Inc

Condensing Units: Air Cooled

- AAF International
- Nuclear Logistics, Inc.

Condensing Units: Water Cooled

- AAF International
- Nuclear Logistics, Inc.
- TRANTER

Configuration Management

- EXPONENT
- Sargent & Lundy
- The Shaw Group Inc., Nuclear Power Division

Connections: Electrical

- Nuclear Logistics, Inc.
- Scientech

Connectors

LEMO SA
Scientech
Staubli Corporation

Connectors: Circuit Board

- Nuclear Logistics, Inc.
- Scientech

Connectors: Electrical

- Mirion Technologies
- Nuclear Logistics, Inc.
- Scientech
- Staubli Corporation

Connectors: Electrical, Ceramic-to-Metal

Staubli Corporation

Connectors: Electrical, Hot Cell

Staubli Corporation

Connectors: Fluid, Hot Cell

Staubli Corporation

Connectors: Metal-to-Metal Clamp

- Mirion Technologies

Connectors: Quick Disconnect

- Nuclear Logistics, Inc.
- Scientech
- Staubli Corporation

Connectors: Quick Disconnect, Safety-Related

- Mirion Technologies
- Nutherm International, Inc.
- Scientech
- Staubli Corporation
- Valcor Engineering Corporation

Construction

- Bechtel Power
- The Shaw Group Inc., Nuclear Power Division

Construction Products

- Arch Wood Protection, Inc.
- E.H. Wachs Co.
- Hydratight

Construction Services

- Babcock & Wilcox Canada
- Bechtel Power
- Bigge Power Constructors
- Burns and Roe
- The Shaw Group Inc., Nuclear Power Division

Construction: Underwater

- Underwater Construction Corporation

Consulting

- Atomic Energy of Canada Limited
- Bartlett Holdings, Inc.
- Black & Veatch
- EXCEL Services Corporation
- EXPONENT
- Holtec International
- NUCON International, Inc.
- RCM Technologies, Inc.
- Sargent & Lundy
- The Shaw Group Inc., Nuclear Power Division
- Western Chemical International Inc.
- Wyle Laboratories, Inc.

Consulting: Ancillary Systems Design

- Power Corporation
- Sargent & Lundy

Consulting: Appendix R

- Advent Engineering Services, Inc.
- Enercon Services, Inc.
- EXCEL Services Corporation
- Philip C. Wagner, P.E.
- Proto-Power Corporation
- Sargent & Lundy

Consulting: Balance-of-Plant

- Enercon Services, Inc.
- ILD, Inc.
- O'Donnell Consulting Engineers, Inc.
- Proto-Power Corporation
- Sargent & Lundy
- Siemens Energy, Inc
- The Shaw Group Inc., Nuclear Power Division

Consulting: Business Management

EXPONENT
Sargent & Lundy

Consulting: Chemical Cleaning

- Atomic Energy of Canada Limited
- Hennigan Engineering Company, Inc.
- Kinectrics Incorporated

Consulting: Chemical Decontamination

- Atomic Energy of Canada Limited

Consulting: Chemistry

- EXPONENT
- UniTech Services Group, Inc., Div. of Unifirst Corp.

Consulting: Clean Air

- Enercon Services, Inc.
- NUCON International, Inc.

Consulting: Computer Network Intrusion Prevention

Talisman International, LLC

Consulting: Computer Network Risk Assessment

Talisman International, LLC

Consulting: Computer Network Security

Talisman International, LLC

BUILDING A WORLD OF DIFFERENCE®



Committed to meeting your nuclear energy needs

Offering full-service nuclear power engineering, procurement and construction (EPC) capabilities, Black & Veatch is prepared to meet the challenges of nuclear power's future. We deliver total solutions, from concept to construction, as owner's engineer or turnkey provider, on all regulatory, security and safety matters. We bring it all together – our tools, technologies and teams – to manage risk and create value for our clients.

Whether providing environmental sustainability, reliable energy, clean air and water, safety or security, we are passionate in our mission, *Building a World of Difference*.

For more information about Black & Veatch's nuclear capabilities, visit www.bv.com or contact Keith Gusich at **913-458-4791**.

Black & Veatch's nuclear offering include:

- > **New-build capabilities**
- > **Operating plant services**
- > **Safety & quality programs**
- > **Reactor technology evaluation**



BLACK & VEATCH
Building a **world** of difference.®

- Consulting: Computer Network Security Training**
Talisman International, LLC
- Consulting: Computer Software**
 - Proto-Power Corporation
 - Research Software Consulting Group, Inc.
 - The Delphi Groupe, Inc.
- Consulting: Computer Systems**
Sargent & Lundy
- Consulting: Computer-Aided Engineering**
Enercon Services, Inc.
O'Donnell Consulting Engineers, Inc.
- Consulting: Configuration Management**
Advent Engineering Services, Inc.
Enercon Services, Inc.
- EXCEL Services Corporation
EXPONENT
Sargent & Lundy
- Consulting: Construction**
EXPONENT
- Consulting: Contract Development**
 - The Shaw Group Inc., Nuclear Power Division
- Consulting: Control Systems**
Enercon Services, Inc.
EXPONENT
- Proto-Power Corporation
- Siemens Energy, Inc.
- Consulting: Cooling Systems**
EXPONENT
- Proto-Power Corporation
- Siemens Energy, Inc.
- Consulting: Data Acquisition Systems**
Enercon Services, Inc.
- Proto-Power Corporation
Sargent & Lundy
Scientech
- Consulting: Decommissioning**
Advanced Consulting Group, Inc.
Applied Consultants, Inc.
- Atomic Energy of Canada Limited
Bartlett Holdings, Inc.
CS-2 Inc.
Cutting Edge Services Corporation
Enercon Services, Inc.
- EXCEL Services Corporation
MOTA Corporation
- Proto-Power Corporation
S.M. Stoller Corp.
Sargent & Lundy
Talisman International, LLC
- The Shaw Group Inc., Nuclear Power Division
TLG Services, Inc., An Entergy Nuclear Company
WMG, Inc.
- Consulting: Decontamination**
Bartlett Holdings, Inc.
Enercon Services, Inc.
MOTA Corporation
Sargent & Lundy
- Consulting: Design & Documentation**
Enercon Services, Inc.
- EXCEL Services Corporation
Sargent & Lundy
- The Shaw Group Inc., Nuclear Power Division
- Consulting: Design Assessment**
Enercon Services, Inc.
- EXCEL Services Corporation
EXPONENT
- Proto-Power Corporation
- The Shaw Group Inc., Nuclear Power Division
- Consulting: Design Basis Documentation**
Advent Engineering Services, Inc.
CTR Technical Services, Inc.
Enercon Services, Inc.
- EXCEL Services Corporation
EXPONENT
Philip C. Wagner, P.E.
- Proto-Power Corporation
Sargent & Lundy
- Consulting: Design Reports**
CTR Technical Services, Inc.
Enercon Services, Inc.
- EXCEL Services Corporation
EXPONENT
- Proto-Power Corporation
- Consulting: Digital Systems**
Enercon Services, Inc.
Sargent & Lundy
- Consulting: Economic Analysis**
Enercon Services, Inc.
Sargent & Lundy
- The Shaw Group Inc., Nuclear Power Division
- Consulting: Effluents Management**
Enercon Services, Inc.
EXPONENT
- Consulting: Electrical**
Enercon Services, Inc.
EXPONENT
- Kinectrics Incorporated
Philip C. Wagner, P.E.
- Proto-Power Corporation
Sargent & Lundy
- Consulting: Electronics**
Homeland-Defense 4 U, Inc.
- Consulting: Emergency Preparedness**
Enercon Services, Inc.
Scientech
- Consulting: Engineering**
Advent Engineering Services, Inc.
- Atomic Energy of Canada Limited
- Black & Veatch
Burns and Roe
CTR Technical Services, Inc.
Design Engineering Analysis Corporation
- EXCEL Services Corporation
- Holtec International
- Joseph Oat Corporation
Northeast Technology Corp.



SOLUTIONS for Our Energy Future

Proto-Power has been serving the nuclear community for decades so we understand the critical role this resource plays in our future.

Our mission is to provide the highest quality engineering, design and project management in the industry. With experienced account managers focusing on a single client, in-depth resources throughout our organization, and the most comprehensive software package available, we support today's operations and offer guidance for tomorrow's challenges.

Proto-Power. Vision for the nuclear future.



PROTO-POWER CORPORATION
a Zachry Group Company

Groton, CT • 860.446.9725
Chicago, IL • 630.357.0156
www.protopower.com

DELIVERING ENGINEERING SOLUTIONS TO THE NUCLEAR POWER INDUSTRY

- NPTS, Inc.
- Proto-Power Corporation
- Sargent & Lundy
- Scientech
- Serdula Systems Ltd.
- Siemens Energy, Inc
- Tecnatom, S.A.
- The Delphi Groupe, Inc.
- The Shaw Group Inc., Nuclear Power Division
- Volian Enterprises, Inc.
- WorleyParsons Group, Inc.

Consulting: Engineering Mechanics

- ABS Consulting
- Enercon Services, Inc.
- EXPONENT
- Proto-Power Corporation
- Siemens Energy, Inc
- Tecnatom, S.A.

Consulting: Engineering: BWR

- Enercon Services, Inc.
- EXCEL Services Corporation
- Scientech

Consulting: Environmental

- Atomic Energy of Canada Limited
- Attenuation Environmental Company
- Enercon Services, Inc.
- EXCEL Services Corporation
- EXPONENT
- Kinectrics Incorporated
- Murray and Trettel, Inc.
- S.M. Stoller Corp.
- Sargent & Lundy

Consulting: Environmental Analysis

- ATI Wah Chang
- Attenuation Environmental Company
- Enercon Services, Inc.
- EXPONENT
- S.E. Logan and Associates, Inc.
- S.M. Stoller Corp.
- Talisman International, LLC
- Tecnatom, S.A.
- The Shaw Group Inc., Nuclear Power Division

Consulting: Environmental Management

- Attenuation Environmental Company
- Eberline Services Inc.
- Enercon Services, Inc.
- EXCEL Services Corporation
- EXPONENT
- S.M. Stoller Corp.

Consulting: Erosion/Corrosion Program

- ATI Wah Chang
- Enercon Services, Inc.
- EXPONENT
- Proto-Power Corporation

Consulting: Erosion/Corrosion Programs

- ATI Wah Chang
- Atlantic Nuclear Services Ltd.
- Enercon Services, Inc.

Consulting: Expert Systems

- EXCEL Services Corporation

Consulting: Filtration

- NUCON International, Inc.

Consulting: Fire Protection

- Enercon Services, Inc.
- EXCEL Services Corporation
- EXPONENT
- Proto-Power Corporation
- Sargent & Lundy
- Scientech

Consulting: Fluid Dynamic Analysis

- ABS Consulting
- Enercon Services, Inc.
- EXPONENT
- Proto-Power Corporation
- Sargent & Lundy

Consulting: Fluid Flow

- Enercon Services, Inc.
- EXPONENT
- Holtec International
- Proto-Power Corporation

Consulting: Fracture Mechanics

- ABS Consulting
- EXPONENT

Consulting: FSAR Licensing Review

- Advent Engineering Services, Inc.
- Enercon Services, Inc.
- EXCEL Services Corporation
- EXPONENT
- Holtec International
- Proto-Power Corporation
- Relcon Scandpower AB
- Sargent & Lundy
- Scientech

Consulting: Hazardous Materials Management

- Enercon Services, Inc.
- EXPONENT

Consulting: Hazardous Waste Management

- Atomic Energy of Canada Limited
- Enercon Services, Inc.
- EXPONENT
- Kinectrics Incorporated
- Sargent & Lundy
- The Shaw Group Inc., Nuclear Power Division

Consulting: Health

- EXPONENT

Consulting: Health Physics

- Applied Consultants, Inc.
- Bartlett Holdings, Inc.
- Eberline Services Inc.
- Enercon Services, Inc.
- Millennium Services, Inc.

Consulting: Heat Exchangers

- ATI Wah Chang
- Holtec International
- Joseph Oat Corporation
- Powerfect
- Proto-Power Corporation

Consulting: Heat Transfer

- Enercon Services, Inc.
- EXPONENT
- Holtec International
- Joseph Oat Corporation
- Proto-Power Corporation

Consulting: HEPA Systems

- NUCON International, Inc.

Consulting: Human Effectiveness

- Conger & Elsea, Inc.
- EXCEL Services Corporation
- Human and Organizational Performance Improvement

Consulting: Human Factors Engineering

- Enercon Services, Inc.
- EXPONENT
- The Macris Group

Consulting: HVAC Systems

- Enercon Services, Inc.
- Nuclear Logistics, Inc.
- NUCON International, Inc.
- Proto-Power Corporation
- Sargent & Lundy

Consulting: Hydraulic

- Enercon Services, Inc.
- EXPONENT
- Proto-Power Corporation

Consulting: Information Management

- EXCEL Services Corporation
- R. Brooks Associates, Inc.
- Sargent & Lundy
- Scientech
- Talisman International, LLC

Consulting: In-Service Inspection Programs

- ABS Consulting
- Enercon Services, Inc.
- EXCEL Services Corporation
- R. Brooks Associates, Inc.
- Sargent & Lundy
- Tecnatom, S.A.

Consulting: Inspection Preparation

- EXCEL Services Corporation

Consulting: Instrumentation & Calibration

- EXCEL Services Corporation
- Proto-Power Corporation
- Sargent & Lundy
- Scientech
- Tecnatom, S.A.

Consulting: IPEEEE

- EXCEL Services Corporation
- Scientech

Consulting: License Renewal

- Enercon Services, Inc.
- EXCEL Services Corporation
- EXPONENT
- O'Donnell Consulting Engineers, Inc.
- Proto-Power Corporation
- Radiation Safety Institute of Canada
- Sargent & Lundy
- Scientech

Consulting: Licensee Event Reports

- Conger & Elsea, Inc.
- Enercon Services, Inc.
- EXCEL Services Corporation
- Talisman International, LLC

Consulting: Licensing

- Advent Engineering Services, Inc.
- Enercon Services, Inc.
- EXCEL Services Corporation
- EXPONENT
- Sargent & Lundy
- Scientech
- UniStar Nuclear Energy

Consulting: Life Cycle Management

- Advent Engineering Services, Inc.
- EXCEL Services Corporation
- EXPONENT
- Proto-Power Corporation
- S.M. Stoller Corp.
- Sargent & Lundy
- Scientech

Consulting: Literature Searches

- EXPONENT
- Interdevelopment, Inc.
- The Shaw Group Inc., Nuclear Power Division

Consulting: Litigation Support

- Enercon Services, Inc.
- EXCEL Services Corporation
- EXPONENT
- Interdevelopment, Inc.
- O'Donnell Consulting Engineers, Inc.
- Talisman International, LLC

Consulting: LOCA Analysis

- Enercon Services, Inc.
- Relcon Scandpower AB
- Sargent & Lundy
- Scientech

Consulting: Maintenance

- Atomic Energy of Canada Limited
- Bartlett Holdings, Inc.
- Climax Portable Machine Tools, Inc.
- EXPONENT
- Herguth Laboratories
- Sargent & Lundy
- Siemens Energy, Inc

Consulting: Maintenance Programs

- Climax Portable Machine Tools, Inc.
- Collier Associates, Inc.
- EXCEL Services Corporation
- EXPONENT
- Herguth Laboratories
- Relcon Scandpower AB
- Sargent & Lundy
- Siemens Energy, Inc

Consulting: Management

- Collier Associates, Inc.
- EXCEL Services Corporation
- EXPONENT
- Sargent & Lundy
- The Shaw Group Inc., Nuclear Power Division

Consulting: Management Effectiveness Reviews

- Collier Associates, Inc.
- Conger & Elsea, Inc.
- Enercon Services, Inc.
- EXCEL Services Corporation
- EXPONENT
- Kinectrics Incorporated
- Suncoast Solutions, Inc.
- Talisman International, LLC

Consulting: Management Information

- EXCEL Services Corporation
- O'Donnell Consulting Engineers, Inc.
- Scientech

Consulting: Management Studies

- EXCEL Services Corporation

Consulting: Margin Management Programs

- Proto-Power Corporation
- The Shaw Group Inc., Nuclear Power Division

Consulting: Marketing

- EXCEL Services Corporation
- Interdevelopment, Inc.

Consulting: Material Management

- EXPONENT
- Sargent & Lundy
- Scientech

Consulting: Materials Analysis

- Atomic Energy of Canada Limited
- EXPONENT

Consulting: Materials Engineering

- Atomic Energy of Canada Limited
- EXPONENT
- Northeast Technology Corp.
- O'Donnell Consulting Engineers, Inc.
- Sargent & Lundy
- Tecnatom, S.A.

Consulting: Metallurgical Analysis

- Atomic Energy of Canada Limited
- EXPONENT

Consulting: Meteorological

- Murray and Trettel, Inc.

Consulting: Modifications

- Enercon Services, Inc.
- ILD, Inc.
- Proto-Power Corporation
- Sargent & Lundy
- The Shaw Group Inc., Nuclear Power Division

Consulting: Motors

- EXPONENT
- Schulz Electric Company

Consulting: Nuclear

- Atomic Energy of Canada Limited
- Bechtel Power
- Black & Veatch
- CTR Technical Services, Inc.
- Enercon Services, Inc.
- EXCEL Services Corporation
- Northeast Technology Corp.
- S.M. Stoller Corp.
- Sargent & Lundy
- Scientech
- The Shaw Group Inc., Nuclear Power Division
- TransWare Enterprises Inc.
- WMG, Inc.

Consulting: Nuclear Fuel Cycles

- Atomic Energy of Canada Limited

Consulting: Nuclear Steam Supply System

- EXCEL Services Corporation
- Proto-Power Corporation
- Scientech

Consulting: Operations

- Enercon Services, Inc.
- EXCEL Services Corporation
- Sargent & Lundy
- Tecnatom, S.A.

Consulting: Operations Analysis

- EXCEL Services Corporation
- Tecnatom, S.A.

Consulting: Operator Performance Enhancement

- EXCEL Services Corporation

Consulting: Organization Effectiveness

- Conger & Elsea, Inc.
- EXCEL Services Corporation
- EXPONENT
- Human and Organizational Performance Improvement
- The Macris Group

Consulting: Organizational Development

- EXCEL Services Corporation
- EXPONENT
- The Macris Group

Consulting: Outage Management

- EXCEL Services Corporation
- Sargent & Lundy
- The Shaw Group Inc., Nuclear Power Division

Consulting: Pipe Support

- EXPONENT
- O'Donnell Consulting Engineers, Inc.
- Proto-Power Corporation
- The Shaw Group Inc., Nuclear Power Division

Consulting: Piping

- Enercon Services, Inc.
- EXPONENT
- O'Donnell Consulting Engineers, Inc.
- Proto-Power Corporation
- Sargent & Lundy
- The Shaw Group Inc., Nuclear Power Division

Consulting: Planning & Scheduling

- Bartlett Holdings, Inc.
- EXCEL Services Corporation

Consulting: Plant Life Extension

- Atomic Energy of Canada Limited
- Black & Veatch
- EXCEL Services Corporation
- EXPONENT
- O'Donnell Consulting Engineers, Inc.
- Proto-Power Corporation
- Sargent & Lundy
- Siemens Energy, Inc.
- Tecnatom, S.A.

Consulting: Plant Performance Analysis

- EXCEL Services Corporation
- Proto-Power Corporation
- S.M. Stoller Corp.
- Scientech
- Siemens Energy, Inc.

Consulting: Plant Performance Improvement

- Collier Associates, Inc.
- EXCEL Services Corporation
- GE Hitachi Nuclear Energy
- Proto-Power Corporation
- Sargent & Lundy
- Scientech
- The Shaw Group Inc., Nuclear Power Division

Consulting: Preventive Maintenance

- Climax Portable Machine Tools, Inc.
- EXCEL Services Corporation
- EXPONENT
- S.M. Stoller Corp.
- Sargent & Lundy
- Siemens Energy, Inc.

Consulting: Problem Solving

- Conger & Elsea, Inc.
- EXPONENT
- O'Donnell Consulting Engineers, Inc.
- Siemens Energy, Inc.

Consulting: Procedure Development

- EXCEL Services Corporation
- Scientech
- Siemens Energy, Inc.
- Volian Enterprises, Inc.

Consulting: Procedure Validation

- EXCEL Services Corporation
- Scientech
- Siemens Energy, Inc.

Consulting: Procedure Verification

- EXCEL Services Corporation
- Scientech
- Siemens Energy, Inc.

Consulting: Process Safety

- EXCEL Services Corporation
- EXPONENT
- Relcon Scandpower AB

Consulting: Procurement Support

- EXPONENT
- G.D. Barri & Associates, Inc.
- Interdevelopment, Inc.
- Scientech

Consulting: Productivity Improvement

- EXCEL Services Corporation
- EXPONENT

Consulting: Program Assessment

- Enercon Services, Inc.
- EXCEL Services Corporation
- Sargent & Lundy

Consulting: Project Management

- Bartlett Holdings, Inc.
- EXCEL Services Corporation
- EXPONENT
- Proto-Power Corporation
- Siemens Energy, Inc.
- The Shaw Group Inc., Nuclear Power Division

Consulting: Project Planning

- EXCEL Services Corporation
- MOTA Corporation
- Siemens Energy, Inc.

Consulting: Prudence Studies

- EXCEL Services Corporation
- EXPONENT
- Sargent & Lundy
- Talisman International, LLC

Consulting: Pumps

- Enercon Services, Inc.
- EXPONENT
- Flowsolve Pump Division

Consulting: Quality Assurance

- Collier Associates, Inc.
- Energy Resources Group, Inc.
- EXCEL Services Corporation
- Proto-Power Corporation
- Sargent & Lundy
- Scientech
- Sonic Systems International, Inc.
- The Shaw Group Inc., Nuclear Power Division
- Trust Manufacturing

Consulting: Quality Control

- EXCEL Services Corporation
- Sargent & Lundy
- Sonic Systems International, Inc.
- Tecnatom, S.A.

Consulting: Radiation Analysis

- Holtec International
- Relcon Scandpower AB
- Sargent & Lundy
- The Shaw Group Inc., Nuclear Power Division

Consulting: Radiation Exposure

- S.E. Logan and Associates, Inc.
- Suncoast Solutions, Inc.

Consulting: Radiation Monitoring

- Enercon Services, Inc.
- Relcon Scandpower AB

Consulting: Radiochemistry

- Eberline Services Inc.
- Kinectrics Incorporated

Consulting: Radiological

- Holtec International
- Suncoast Solutions, Inc.
- WMG, Inc.

Consulting: Radwaste

- Atomic Energy of Canada Limited
- Eberline Services Inc.
- Kinectrics Incorporated
- Sargent & Lundy
- Suncoast Solutions, Inc.
- The Delphi Groupe, Inc.
- WMG, Inc.

Consulting: Reactor Engineering

- Atlantic Nuclear Services Ltd.
- Atomic Energy of Canada Limited
- CTR Technical Services, Inc.
- EXCEL Services Corporation
- TransWare Enterprises Inc.

Consulting: Reactor Materials

- ATI Wah Chang
- Atomic Energy of Canada Limited

Consulting: Reactor Safety

- Atomic Energy of Canada Limited
- EXCEL Services Corporation
- Scientech

Consulting: Reactor Vessel

- O'Donnell Consulting Engineers, Inc.



Shaw[®]
a world of **Solutions**[™]



62M092008D

Just Imagine

Meet the increased demand for clean energy with a partner focused on your goals. Whether you are considering new nuclear power plant construction or maintenance of existing nuclear facilities, Shaw brings the expertise you need—new AP1000[™] nuclear power plant construction in China and the U.S. as part of our consortium with Westinghouse, maintenance contracts at 41 nuclear power plant units in the U.S. and power uprates that have added more than 2,200 MWe to the U.S. grid. Imagine what we can do for you.

www.shawgrp.com

DESIGN • ENGINEERING • PROCUREMENT • CONSTRUCTION • START UP & TEST • MAINTENANCE & MODIFICATIONS
SHAW POWER GROUP, NUCLEAR DIVISION

Consulting: Records Management Systems

Enercon Services, Inc.

- EXCEL Services Corporation
Sargent & Lundy

Consulting: Regulatory Compliance

Attenuation Environmental Company
Enercon Services, Inc.

- EXCEL Services Corporation
EXPONENT
O'Donnell Consulting Engineers, Inc.
Philip C. Wagner, P.E.
- Proto-Power Corporation
Relcon Scandpower AB
Sargent & Lundy
Scientech
Talisman International, LLC
WMG, Inc.

Consulting: Reliability Analysis

- EXCEL Services Corporation
EXPONENT
O'Donnell Consulting Engineers, Inc.
Relcon Scandpower AB
S.M. Stoller Corp.
Sargent & Lundy
Scientech

Consulting: Remote Systems Applications

- Advanced Consulting Group, Inc.
- Atomic Energy of Canada Limited
R. Brooks Associates, Inc.
- Tecnatom, S.A.

Consulting: Remotely Operated Vehicles

EXPONENT

Consulting: Research & Development

- Atomic Energy of Canada Limited
- EXCEL Services Corporation

Consulting: Residual Life Assessment

EXPONENT
O'Donnell Consulting Engineers, Inc.
Sargent & Lundy

Consulting: Resin Service

Epicor, Inc.

Consulting: Risk Analysis

- ABS Consulting
Conger & Elsea, Inc.
Enercon Services, Inc.
- EXCEL Services Corporation
EXPONENT
Relcon Scandpower AB
S.E. Logan and Associates, Inc.
Sargent & Lundy
Scientech

Consulting: Risk Management

- EXCEL Services Corporation
EXPONENT
Relcon Scandpower AB
Talisman International, LLC

Consulting: Robotics

- Atomic Energy of Canada Limited
EXPONENT
R. Brooks Associates, Inc.

Consulting: Root Cause Analysis

- Conger & Elsea, Inc.
Enercon Services, Inc.
- EXCEL Services Corporation
EXPONENT
- Kinectrics Incorporated
O'Donnell Consulting Engineers, Inc.
- Proto-Power Corporation
Sargent & Lundy

Consulting: Scaffolding Design/Engineering

Bartlett Holdings, Inc.

Consulting: Scientific

- Atomic Energy of Canada Limited

Consulting: Security

- ABS Consulting
Enercon Services, Inc.
Sargent & Lundy
Scientech
Valnerability Assessment Team, Argonne National
Laboratory

Consulting: Seismic

ABS Consulting
EXPONENT

- Holtec International
- Joseph Oat Corporation
Sargent & Lundy

Consulting: Self-Assessment

Enercon Services, Inc.
EXCEL Services Corporation
Philip C. Wagner, P.E.
Sargent & Lundy

Consulting: Setpoint Analyses

- Enercon Services, Inc.
- EXCEL Services Corporation
- Proto-Power Corporation
Sargent & Lundy

Consulting: Siting

Enercon Services, Inc.
S.M. Stoller Corp.
Sargent & Lundy

Consulting: Solid Waste Management

WMG, Inc.

Consulting: Steam Generators

- Atomic Energy of Canada Limited
- Babcock & Wilcox Canada
- Joseph Oat Corporation
O'Donnell Consulting Engineers, Inc.
R. Brooks Associates, Inc.
- Siemens Energy, Inc.

Consulting: Strategic Alliance

- Siemens Energy, Inc.

Consulting: Strategic Planning

- EXPONENT
O'Donnell Consulting Engineers, Inc.
Sargent & Lundy
- Siemens Energy, Inc.

Consulting: Stress, Material

- Atomic Energy of Canada Limited
EXPONENT
O'Donnell Consulting Engineers, Inc.
WMG, Inc.

Consulting: Structural

- ABS Consulting
Enercon Services, Inc.
EXPONENT
- Holtec International
O'Donnell Consulting Engineers, Inc.
- Proto-Power Corporation
Sargent & Lundy
WMG, Inc.

Consulting: Surveillance Procedures

- EXCEL Services Corporation

Consulting: System Design

- Enercon Services, Inc.
- Proto-Power Corporation
Sargent & Lundy

Consulting: System Safety

- Conger & Elsea, Inc.
Enercon Services, Inc.
- EXCEL Services Corporation
EXPONENT
- Proto-Power Corporation
Scientech

Consulting: Technical Assessments

- Advent Engineering Services, Inc.
- Atomic Energy of Canada Limited
- EXCEL Services Corporation
EXPONENT
- Proto-Power Corporation
Sargent & Lundy

Consulting: Technical Specifications

- EXCEL Services Corporation
Relcon Scandpower AB

Consulting: Technical Staff

- EXCEL Services Corporation

Consulting: Television Systems

- Mirion Technologies
R. Brooks Associates, Inc.

Consulting: Thermal Analysis

- EXPONENT
Holtec International
O'Donnell Consulting Engineers, Inc.

- Proto-Power Corporation
Sargent & Lundy

Consulting: Thermal-Hydraulics

- Atomic Energy of Canada Limited
Enercon Services, Inc.
EXPONENT
- Holtec International
- Proto-Power Corporation
Relcon Scandpower AB
Sargent & Lundy

Consulting: Third Party Review

- EXCEL Services Corporation
EXPONENT
O'Donnell Consulting Engineers, Inc.
- Proto-Power Corporation
Sargent & Lundy
Talisman International, LLC

Consulting: Training

- EXCEL Services Corporation
- Tecnatom, S.A.

Consulting: Trend Analysis Program

- EXCEL Services Corporation
Interdevelopment, Inc.
- Proto-Power Corporation

Consulting: TRU Waste

Eberline Services Inc.
S.M. Stoller Corp.

Consulting: Tube Plugging

- Joseph Oat Corporation

Consulting: Valve Actuators

- Copes-Vulcan, An SPX Brand
EXPONENT
Sargent & Lundy

Consulting: Valves

- Copes-Vulcan, An SPX Brand
EXPONENT
Sargent & Lundy

Consulting: Vendor Manual Upgrades

- EXCEL Services Corporation
Scientech

Consulting: Ventilation System

- Enercon Services, Inc.
- Proto-Power Corporation

Consulting: Verification & Validation

- EXCEL Services Corporation
O'Donnell Consulting Engineers, Inc.

Consulting: Waste Management

- Applied Consultants, Inc.
- Atomic Energy of Canada Limited
Attenuation Environmental Company
Eberline Services Inc.
Enercon Services, Inc.
Fortum Nuclear Services Ltd.
S.M. Stoller Corp.
Sargent & Lundy
WMG, Inc.

Consulting: Water Treatment

EXPONENT
Sargent & Lundy

Contactors: Safety-Related

- Nuclear Logistics, Inc.
Nutherm International, Inc.
Scientech
Wyle Laboratories, Inc.

Containers: Disposal

- Joseph Oat Corporation

Containers: Lead

Biodex Medical Systems
LANCS Industries, Inc.
Precision Custom Components, LLC
Tri Nuclear Corporation

Containers: Radwaste

- AT&F Nuclear, Inc, Division of American Tank and
Fabricating
Biodex Medical Systems
Container Products Corporation
- Joseph Oat Corporation
- Kinectrics Incorporated
LANCS Industries, Inc.
Precision Custom Components, LLC
Waste Control Systems, Inc.
WMG, Inc.

Containers: Shielded

- Biodex Medical Systems
- Container Products Corporation
- Frontier Technology Corporation
- LANCS Industries, Inc.
- Precision Custom Components, LLC

Containers: Steel

- Container Products Corporation
- Precision Custom Components, LLC
- Trust Manufacturing

Containers: Storage

- AT&F Nuclear, Inc. Division of American Tank and Fabricating
- Container Products Corporation
- Joseph Oat Corporation
- UniTech Services Group, Inc., Div. of Unifirst Corp.

Containers: Storage Products

- Biodex Medical Systems
- Reef Industries, Inc.

Containers: Transport

- AT&F Nuclear, Inc. Division of American Tank and Fabricating
- Container Products Corporation
- GE Hitachi Nuclear Energy
- Hilman Inc.
- Joseph Oat Corporation
- Precision Custom Components, LLC
- UniTech Services Group, Inc., Div. of Unifirst Corp.
- Waste Control Systems, Inc.

Containers: Waste

- Biodex Medical Systems
- Container Products Corporation
- Precision Custom Components, LLC
- Trust Manufacturing

Containment Analysis

- EXPONENT
- The Shaw Group Inc., Nuclear Power Division

Containment Products: DOT

- Reef Industries, Inc.

Containment Structures

- AT&F Nuclear, Inc. Division of American Tank and Fabricating
- LANCS Industries, Inc.

Containment Tents

- Herculite Products
- LANCS Industries, Inc.
- Reef Industries, Inc.

Contract Engineering Services

- EXCEL Services Corporation
- G.D. Barri & Associates, Inc.
- Joseph Oat Corporation
- Tecnatom, S.A.
- Wyle Laboratories, Inc.

Control Cabinets

- Nuclear Logistics, Inc.
- Schulz Electric Company
- Wyle Laboratories, Inc.

Control Equipment: Power Distribution

- Trentec, Inc.

Control Panel Design

- Data Systems & Solutions SAS
- Nuclear Logistics, Inc.
- Proto-Power Corporation
- Schulz Electric Company
- Scientech
- Trentec, Inc.

Control Panels: 1E

- Data Systems & Solutions SAS
- Nuclear Logistics, Inc.
- Nutherm International, Inc.
- Scientech
- Stacosystems
- Trentec, Inc.
- Wyle Laboratories, Inc.

Control Panels: Safety-Related

- Data Systems & Solutions SAS
- Engine Systems, Inc.
- Kinectrics Incorporated
- Nuclear Logistics, Inc.
- Nutherm International, Inc.
- Scientech
- Trentec, Inc.
- Wyle Laboratories, Inc.

Control Rod Blades: BWR

- GE Hitachi Nuclear Energy

Control Rod Control System Maintenance

- Data Systems & Solutions SAS
- Scientech

Control Rod Control Systems

- Data Systems & Solutions SAS
- Scientech

Control Rod Drive Maintenance

- Data Systems & Solutions SAS
- Scientech

Control Rod Drive Mechanisms

- SKODA JS a.s.

Control Rod Position Indicators

- Data Systems & Solutions SAS

Control Rods

- Data Systems & Solutions SAS
- GE Hitachi Nuclear Energy

Control Room Consoles: Class 1E

- Data Systems & Solutions SAS
- Nuclear Logistics, Inc.
- Scientech

Control Systems

- Air Monitor Corp.
- Black & Veatch
- Data Systems & Solutions SAS
- Emerson Process Management
- Henry Pratt Company, Sub. of Mueller Co.
- Proto-Power Corporation
- Siemens Energy, Inc.
- Tecnatom, S.A.
- Trentec, Inc.

Control Systems: Automated

- Data Systems & Solutions SAS
- Siemens Energy, Inc.

Control Systems: Class 1E

- Data Systems & Solutions SAS
- Kinectrics Incorporated
- Mirion Technologies
- Nuclear Logistics, Inc.
- Nutherm International, Inc.
- Scientech
- Siemens Energy, Inc.
- Trentec, Inc.

Control Systems: Computer-Assisted

- Data Systems & Solutions SAS

Control Systems: Distributive

- Data Systems & Solutions SAS

Control Systems: Safety

- Data Systems & Solutions SAS
- Mirion Technologies

Control Systems: Supervisory

- Data Systems & Solutions SAS

Controllers: Analog

- Data Systems & Solutions SAS
- Nuclear Logistics, Inc.
- Scientech

Controllers: Flow

- HI-Q Environmental Products Company
- Nuclear Logistics, Inc.
- Trentec, Inc.
- Wyle Laboratories, Inc.

Controllers: Mass Flow

- HI-Q Environmental Products Company

Controllers: Pressure

- Nuclear Logistics, Inc.
- Trentec, Inc.
- Wyle Laboratories, Inc.

Controllers: Programmable

- Nuclear Logistics, Inc.
- Scientech
- Southern Testing Services, a Division of ATC
- Trentec, Inc.

Controllers: Temperature

- Nuclear Logistics, Inc.
- Trentec, Inc.
- Wyle Laboratories, Inc.

Converters

- Data Systems & Solutions SAS

Converters: Safety-Related

- Data Systems & Solutions SAS
- Kinectrics Incorporated
- Nuclear Logistics, Inc.
- Nutherm International, Inc.
- Scientech
- Trentec, Inc.
- Wyle Laboratories, Inc.

Coolant Circulators

- Howden UK Ltd
- Scientech

Coolers: Containment

- AAF International
- Aerofin Corporation
- Black & Veatch
- Joseph Oat Corporation

Coolers: Cubicle Coolers

- AAF International
- Black & Veatch

Coolers: Direct Expansion (DX) Refrigerant

- Flowserve Pump Division
- TRANSTER

Coolers: Drywell

- AAF International
- Aerofin Corporation
- Black & Veatch

Coolers: Fan Coil Units

- AAF International
- Black & Veatch

Coolers: MCC

- Black & Veatch

Cooling Systems: Forced Air

- Nuclear Logistics, Inc.

Cooling Towers

- Black & Veatch

Cooling Water Intake Maintenance

- Underwater Construction Corporation

Corrosion Control

- ATI Wah Chang
- Atomic Energy of Canada Limited
- Black & Veatch
- CC Technologies, Inc., A DNV Company
- Sargent & Lundy
- Underwater Construction Corporation

Corrosion Coupons

- ATI Wah Chang
- CC Technologies, Inc., A DNV Company

Corrosion Monitoring

- ATI Wah Chang
- CC Technologies, Inc., A DNV Company

Corrosion Surveys

- ATI Wah Chang
- CC Technologies, Inc., A DNV Company
- Sonic Systems International, Inc.

Corrosion Testing Laboratory

- ATI Wah Chang
- Atomic Energy of Canada Limited
- CC Technologies, Inc., A DNV Company
- Kinectrics Incorporated

Counters: Alpha/Beta

- Biodex Medical Systems
- Gamma Products, Inc.
- Homeland-Defense 4 U, Inc.
- LND, Inc.
- WM B. Johnson & Associates Inc.

Counters: Alpha/Beta, Low-Level

- Gamma Products, Inc.

Counters: BF3

- Data Systems & Solutions SAS
- LND, Inc.
- Mirion Technologies

Counters: Fission

- Data Systems & Solutions SAS
- Mirion Technologies
- Scientech

Counters: Gamma

- Biodex Medical Systems
- Data Systems & Solutions SAS
- Gamma Products, Inc.
- LND, Inc.

- Ludlum Measurements, Inc.
- Mirion Technologies
WM B. Johnson & Associates Inc.

Counters: Neutron REM

- Data Systems & Solutions SAS
- Ludlum Measurements, Inc.

Counters: Neutron, He-3 Proportional

- Data Systems & Solutions SAS
- LND, Inc.

Counters: Particle

Thermo Scientific

Counters: Radiation

- Biodex Medical Systems
- Data Systems & Solutions SAS
- LND, Inc.
- Ludlum Measurements, Inc.
- Mirion Technologies
Saint-Gobain Crystals, (SGC01)
Thermo Scientific
WM B. Johnson & Associates Inc.

Counters: Whole Body

- Canberra Industries, Inc.

Counters: Wipe Test

- Biodex Medical Systems
- Ludlum Measurements, Inc.

Counting Systems

WM B. Johnson & Associates Inc.

Counting Systems: Proportional

- Gamma Products, Inc.
- Mirion Technologies

Counting Systems: Thyroid Uptake

Biodex Medical Systems

Couplants: Ultrasonic NDT

- Interrest, Inc
- Siemens Energy, Inc
- Technisonic Research Inc.

Couplings: Quick-Connect

- Seal Master Corporation

Covers

- Black & Veatch
Euclid Garment Manufacturing Company
Scientech

Crane Control Systems

- American Crane & Equipment Corp.
Morris Material Handling (P&H)
Scientech

Crane Controls

- American Crane & Equipment Corp.
Morris Material Handling (P&H)
Scientech

Crane Retrofits

- American Crane & Equipment Corp.
Morris Material Handling (P&H)
Scientech

Crane Retrofits: Single-Failure-Proof

- American Crane & Equipment Corp.
Morris Material Handling (P&H)
Scientech

Crane Service

- American Crane & Equipment Corp.
- Bigge Power Constructors
Morris Material Handling (P&H)
Scientech

Cranes

- American Crane & Equipment Corp.
- Black & Veatch
Morris Material Handling (P&H)
Scientech

Cranes: Anti-Collision Systems

- American Crane & Equipment Corp.
Morris Material Handling (P&H)

Cranes: Containment Polar

- American Crane & Equipment Corp.
Morris Material Handling (P&H)

Cranes: Electric

- American Crane & Equipment Corp.
Morris Material Handling (P&H)

Cranes: Fuel Building (Cask Handling)

- American Crane & Equipment Corp.
J&R Engineering Company, Inc.
Morris Material Handling (P&H)
Scientech

Cranes: Fuel Pool

- American Crane & Equipment Corp.
Morris Material Handling (P&H)
Scientech

Cranes: Gantry

- American Crane & Equipment Corp.
J&R Engineering Company, Inc.
Morris Material Handling (P&H)

Cranes: Generically Licensable Type I

- American Crane & Equipment Corp.
Morris Material Handling (P&H)

Cranes: Overhead

- American Crane & Equipment Corp.
Morris Material Handling (P&H)

Cranes: Radio Controls

- American Crane & Equipment Corp.
Morris Material Handling (P&H)

Cranes: Radwaste

- American Crane & Equipment Corp.
Morris Material Handling (P&H)

Cranes: Safety System

- American Crane & Equipment Corp.
Morris Material Handling (P&H)

Cranes: Single-Failure-Proof

- American Crane & Equipment Corp.
- Bigge Power Constructors
Morris Material Handling (P&H)

Cranes: Type I

- American Crane & Equipment Corp.
Morris Material Handling (P&H)

Crushers: Drum

S&G Enterprises, Inc.

Cutting Equipment: Underwater

- E.H. Wachs Co.
Hydratight
MOTA Corporation
- Underwater Construction Corporation

Cutting: Ultra High-Pressure

Hennigan Engineering Company, Inc.

Cutting: Underwater

Advanced Consulting Group, Inc.
Hennigan Engineering Company, Inc.
Hydratight

Cylinders: Hydraulic

J&R Engineering Company, Inc.

Dampeners: Pulsation

AT&F Nuclear, Inc. Division of American Tank and

Fabricating

- Joseph Oat Corporation
Scientech

Damper Operators

- American Warming & Ventilating
- Nuclear Logistics, Inc.
Scientech
- SSM Industries, Inc.
Wyle Laboratories, Inc.

Dampers: Backdraft

- American Warming & Ventilating
- Nuclear Logistics, Inc.
Scientech
- SSM Industries, Inc.

Dampers: Bubble Tight

- American Warming & Ventilating
Scientech
- SSM Industries, Inc.
Wyle Laboratories, Inc.

Dampers: Control

- American Warming & Ventilating
- Nuclear Logistics, Inc.

ASME NQA-1
NUPIC Audited

ASME AG-1
IEEE
Qualified designs

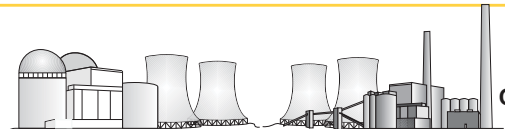

INDUSTRIES, INC.
POWER DIVISION

Formally Schneider Sheet Metal

Providing Safety Related
HVAC equipment and services
for over 30 years

Complete HVAC Systems

All Safety Related Components including:

Access Doors

Actuators:

Electric
Pneumatic
Electro-hydraulic

Air Handling Units

Charcoal Adsorber Units

Dampers:

Backdraft
Balancing
Bubble-tight
Control

Dampers (con't):

Diverter
Fire & Smoke
Gullotine
HEPA
Isolation
Tornado

Ductwork & Supports

Fans:

Centrifugal
Axial
Prop
High Pressure

Flexible Connections

HEPA Filter Units

Package AC Units

Field Services:

Complete Installation
Field Engineering
Test & Balance

**120,000 ft² high
bay crane fabrication
facility**

3401 Grand Ave. Pittsburgh PA 15225 - 412.777.5101- www.ssmi.biz

Powerful Innovation. Proven Experience.

American Crane can help you navigate through uncharted waters.

Your complete source for specialized Nuclear Material Handling Solutions for current plant needs and the next generation of nuclear power plants.



NQA-1 QA Program
and Testing

Installation,
Site Services and Parts

Single Failure
Proof Cranes

In-House
Manufacturing

Engineering
Solutions

For more information call 1-877-877-6778 x224
or visit www.americancrane.com

A Member of  **CMAA**
CONSTRUCTION MANAGEMENT ASSOCIATION OF AMERICA, INC.

 **MATERIAL HANDLING
INDUSTRY
OF AMERICA**
Member Company

ACECO
 **AMERICAN CRANE
& EQUIPMENT CORPORATION**
Your **Critical Lift** Experts

- Scientech
- SSM Industries, Inc.
Wyle Laboratories, Inc.
- Dampers: Electric**
American Warming & Ventilating
- Nuclear Logistics, Inc.
Scientech
- SSM Industries, Inc.
Wyle Laboratories, Inc.
- Dampers: Fire**
American Warming & Ventilating
- Nuclear Logistics, Inc.
Scientech
- SSM Industries, Inc.
- Dampers: Fire, Testing**
Scientech
- SSM Industries, Inc.
- Dampers: High-Pressure**
American Warming & Ventilating
- Nuclear Logistics, Inc.
Scientech
- SSM Industries, Inc.
Wyle Laboratories, Inc.
- Dampers: Isolation**
American Warming & Ventilating
- Nuclear Logistics, Inc.
Scientech
- SSM Industries, Inc.
Wyle Laboratories, Inc.
- Dampers: Manual**
American Warming & Ventilating
Scientech
- SSM Industries, Inc.
Wyle Laboratories, Inc.
- Dampers: Pneumatic**
American Warming & Ventilating
- Nuclear Logistics, Inc.
Scientech
- SSM Industries, Inc.
Wyle Laboratories, Inc.

- Dampers: Relief**
American Warming & Ventilating
Scientech
- SSM Industries, Inc.
- Dampers: Tornado**
American Warming & Ventilating
Scientech
- SSM Industries, Inc.
- Dampers: Volume**
American Warming & Ventilating
Scientech
- SSM Industries, Inc.
- Data Acquisition Systems**
Acromag, Inc.
- Black & Veatch
Logic Beach Inc.
- Proto-Power Corporation
Scientech
- SOLTEC Corporation
- Zetec, Inc.
- Data Collector: Portable Online**
Logic Beach Inc.
- Data Management Systems**
- Canberra Industries, Inc.
Sargent & Lundy
Scientech
- Zetec, Inc.
- Data Recorders**
Logic Beach Inc.
- Data Recorders: Seismic Qualified**
Engine Systems, Inc.
Nuthern International, Inc.
Wyle Laboratories, Inc.
- Database Design/Development**
- EXCEL Services Corporation
- Proto-Power Corporation
Sargent & Lundy
- Trust Manufacturing
- Database Services: Part Availability**
Platts UDI

- STN Service Center Europe
Wyle Laboratories, Inc.
- Deaerators**
- Joseph Oat Corporation
- Debris Recovery Services**
- Underwater Construction Corporation
- Decommissioning Equipment**
E.H. Wachs Co.
- Decommissioning Services**
Advanced Consulting Group, Inc.
American DND Inc.
- ANSALDO NUCLEARE SPA
Argonne National Laboratory
- Atomic Energy of Canada Limited
Bartlett Holdings, Inc.
- Bigge Power Constructors
- Black & Veatch
Bluegrass Concrete Cutting, Inc.
E.H. Wachs Co.
Enercon Services, Inc.
- EXCEL Services Corporation
MOTA Corporation
Rigging International
Sargent & Lundy
- Studsvik, Inc.
The Delphi Groupe, Inc.
- The Shaw Group Inc., Nuclear Power Division
- Underwater Construction Corporation
WMG, Inc.
- Decontamination**
American DND Inc.
- Atomic Energy of Canada Limited
Enercon Services, Inc.
Hennigan Engineering Company, Inc.
MOTA Corporation
- Schulz Electric Company
- The Shaw Group Inc., Nuclear Power Division
- UniTech Services Group, Inc., Div. of Unifirst Corp.
- Decontamination Equipment**
Bartlett Holdings, Inc.
Bluegrass Concrete Cutting, Inc.
- Canberra Industries, Inc.
Container Products Corporation
Diversified Technologies Services, Inc.
Hennigan Engineering Company, Inc.
Hydratight
ICM - International Climbing Machines
LANCS Industries, Inc.
Pentek Decontamination Products DIV.
- UniTech Services Group, Inc., Div. of Unifirst Corp.
- Decontamination Equipment (Cask)**
Precision Custom Components, LLC
- Decontamination Equipment: Radioactive Gas**
- NUCON International, Inc.
- Decontamination Processes**
Bartlett Holdings, Inc.
Hennigan Engineering Company, Inc.
- Kinectrics Incorporated
R. Brooks Associates, Inc.
- Decontamination Services**
- Atomic Energy of Canada Limited
Bartlett Holdings, Inc.
Bluegrass Concrete Cutting, Inc.
Fuel Tank Maintenance Company LLC
Hennigan Engineering Company, Inc.
Hydratight
- Kinectrics Incorporated
MOTA Corporation
PTP Spent Fuel Services, LLC.
- Schulz Electric Company
- UniTech Services Group, Inc., Div. of Unifirst Corp.
- Decontamination Services: Offsite**
- Schulz Electric Company
- Studsvik, Inc.
- UniTech Services Group, Inc., Div. of Unifirst Corp.
- Decontamination Supplies**
Bartlett Holdings, Inc.
Biodex Medical Systems
- Mohawk Industrial & Nuclear Supply, Inc.
- UniTech Services Group, Inc., Div. of Unifirst Corp.
- Decontamination: CO2**
- Schulz Electric Company
- UniTech Services Group, Inc., Div. of Unifirst Corp.



Your Map To Offsite Metal Decon



- **Offsite Tool and Metal Decontamination**
CO2, Plastic Bead, Ultrasonic, High Pressure Water, Steam
- **T.E.M.P.™ Tool & Equipment Management Program**
Outage management of customer equipment; long term storage
- **Tool and Equipment Leasing**
HEPA ventilation; tools and scaffolding; HP instruments



**Transport
Services**

**11 Licensed
Facilities**



**UniTech
Services Group**
(800) 344-3824
www.unitech.ws

Radiation-101, An Internet-Based Course on Radiation Fundamentals

With 2.4 CEUs (24 PDHs) from the Illinois Institute of Technology

Start Date: February 2, 2009

Fax Registration to (630) 858-8787

Radiation Fundamentals (Radiation-101) runs for seven weeks beginning February 2, 2009. Each week, participants complete a reading assignment and submit required tests electronically. A list of assignments is given at the right. The test responses are graded instantly, and participants may view their grades immediately. At the end of the course, a certificate and 2.4 Continuing Education Units (CEUs) from the Illinois Institute of Technology will be issued to those participants who successfully complete the course work. The course registration fee is \$245.00 per participant.

Course author Dr. Bjorn Wahlstrom has written several books on radiation. He is a well-known nuclear physicist with experience in radiation safety, radioactive releases, radwaste, the deposition of spent nuclear fuel and environmental issues.

Newal K. Agnihotri, editor and publisher of Nuclear Plant Journal, is the moderator of the course.

Yes! Register me for the Radiation-101 class.

Course Start Date: February 2, 2009

\$245.00 per course per participant

_____ Amount authorized (fee x # of participants)

Check is enclosed.

(Make checks payable to *Nuclear Plant Journal*.)

Charge my credit card.

American Express® MasterCard® VISA®

Card Number _____

Expiration Date _____

Card Holder Name (Print) _____

Signature _____

Date _____

Send payment with your order.

Name _____

Birthday (Month/Day/Year) _____

Company _____

Address _____

Phone _____

E-mail _____

Fax or mail your order to:

Michelle Yong Phone: (630) 858-6161, X103
Nuclear Plant Journal Fax: (630) 858-8787
799 Roosevelt Rd., #6-208 E-mail: NPJ@goinfo.com
Glen Ellyn, IL 60137 USA

Course Topics for December 1, 2008 Session

Week 1: (February 2-8, 2009)

1. "Radiation—As Old As the Universe."
2. "Unstable Nuclei Make Material Radioactive."
3. "The Unit of Activity, The Becquerel."

Week 2: (February 9-15, 2009)

1. "Radionuclides & Your Body."
2. "Healing Radiation."

Week 3: (February 16-22, 2009)

1. "Industrial & Consumer Applications."
2. "Radiation Protection Across Borders."
3. "Dose, Dose Rate and Dose Limits."

Week 4: (February 23- March 1, 2009)

1. "Ionizing Radiation & Health."
2. "Any Harm from Small Doses?"



Photo Credit: Pavlicek/IAEA

Week 5: (March 2-8, 2009)

1. "Late Health Effects of High Doses."
2. "Acute Health Effects of Very High Doses."

Week 6: (March 9-15, 2009)

1. "Nuclear Accident or Incident?"
2. "Radioactive Releases and Radwaste."

Week 7: (March 16-22, 2009)

1. "True and False About Chernobyl."
2. "Radiation All Around Us All the Time."

Bulk registration costs are available for orders of 10+ participants.

www.radiationtraining.com

December, 2008

With 2.4 CEUs from the Illinois Institute of Technology in Chicago

Decontamination: Steel Equipment

- Westerman Nuclear

Degrees: Nuclear Technology

Excelsior College

Demineralization Equipment

Tri Nuclear Corporation

Design Basis Reconstitution

Advent Engineering Services, Inc.

Enercon Services, Inc.

- EXCEL Services Corporation
- Proto-Power Corporation
- Sargent & Lundy
- The Shaw Group Inc., Nuclear Power Division

Design Review

- Data Systems & Solutions SAS
- EXCEL Services Corporation
- EXPONENT

Design Services

- AREVA Inc., AREVA NC Inc.
- Atomic Energy of Canada Limited
- Bechtel Power
- Black & Veatch
- Data Systems & Solutions SAS
- Design Engineering Analysis Corporation
- Enercon Services, Inc.
- EXCEL Services Corporation
- Joseph Oat Corporation
- O'Donnell Consulting Engineers, Inc.
- Proto-Power Corporation
- RCM Technologies, Inc.
- Sargent & Lundy
- Scientech
- The Shaw Group Inc., Nuclear Power Division

Design: Computer-Aided

Enercon Services, Inc.

Design: Control Panel

- Data Systems & Solutions SAS
- Schulz Electric Company
- Scientech

Design: Electrical

- Data Systems & Solutions SAS
- Enercon Services, Inc.
- Homeland-Defense 4 U, Inc.
- Proto-Power Corporation
- Sargent & Lundy
- Scientech
- Trentec, Inc.

Design: Mechanical

- Data Systems & Solutions SAS
- Enercon Services, Inc.
- Joseph Oat Corporation
- Proto-Power Corporation
- Sargent & Lundy
- Scientech

Design: Process

- Data Systems & Solutions SAS
- Enercon Services, Inc.

Design: Seismic

- Data Systems & Solutions SAS
- Enercon Services, Inc.
- Joseph Oat Corporation
- Proto-Power Corporation
- Sargent & Lundy
- Trentec, Inc.

Design: Structural

- Enercon Services, Inc.
- Proto-Power Corporation
- Sargent & Lundy
- Trentec, Inc.
- WMG, Inc.

Destructive Testing

Wyle Laboratories, Inc.

Detector Refurbishment

- Mirion Technologies

Detectors: Air Ionization Chamber

- LND, Inc.
- Ludlum Measurements, Inc.

Detectors: BF3

- Data Systems & Solutions SAS
- LND, Inc.
- Ludlum Measurements, Inc.

- Mirion Technologies

Detectors: Combustible Gas

ENMET Corporation

Detectors: Crack

Interest, Inc

Detectors: Ex-Core

- Mirion Technologies
- Thermo Scientific, Part of Thermo Fisher Scientific, Process Instruments Div.

Detectors: Gamma

Biodex Medical Systems

- Canberra Industries, Inc.
- Data Systems & Solutions SAS
- General Atomics Electronic Systems, Inc.
- LND, Inc.
- Ludlum Measurements, Inc.
- Mirion Technologies
- S.E. International, Inc.
- Saint-Gobain Crystals
- Spectra Physics, Hilger Crystals Limited
- Thermo Scientific, Part of Thermo Fisher Scientific, Process Instruments Div.
- WM B. Johnson & Associates Inc.

Detectors: Gas

ENMET Corporation

- General Atomics Electronic Systems, Inc.

Detectors: Gas, Area

Draeger Safety, Inc.

- General Atomics Electronic Systems, Inc.
- Mirion Technologies

Detectors: Gas, Personal

Draeger Safety, Inc.

ENMET Corporation

Detectors: Geiger-Muller

- General Atomics Electronic Systems, Inc.
- LND, Inc.
- Ludlum Measurements, Inc.
- Saint-Gobain Crystals, (SGC01)
- WM B. Johnson & Associates Inc.

Detectors: Germanium

- Canberra Industries, Inc.

Detectors: In-Core

Delta M Corporation

- Mirion Technologies

Detectors: Neutron

- Canberra Industries, Inc.
- Data Systems & Solutions SAS
- LND, Inc.
- Ludlum Measurements, Inc.
- Mirion Technologies
- Thermo Scientific
- Thermo Scientific, Part of Thermo Fisher Scientific, Process Instruments Div.

Detectors: Radiation

Berkeley Nucleonics Corp.

Biodex Medical Systems

- Canberra Industries, Inc.
- Data Systems & Solutions SAS
- General Atomics Electronic Systems, Inc.
- LND, Inc.
- Ludlum Measurements, Inc.
- Mirion Technologies
- ORTEC
- RMD Instrument Corp
- S.E. International, Inc.
- Saint-Gobain Crystals
- Spectra Physics, Hilger Crystals Limited
- Thermo Scientific
- WM B. Johnson & Associates Inc.

Detectors: Radiation, Gas-Filled

- LND, Inc.
- Mirion Technologies
- Saint-Gobain Crystals, (SGC01)
- WM B. Johnson & Associates Inc.

Detectors: Scintillation

Biodex Medical Systems

- General Atomics Electronic Systems, Inc.
- Ludlum Measurements, Inc.
- S.E. International, Inc.
- Saint-Gobain Crystals
- Spectra Physics, Hilger Crystals Limited
- WM B. Johnson & Associates Inc.

Detectors: Ultrasonic Flaw

Interest, Inc

Detergents: Contamination Removing

Biodex Medical Systems

Dewatering & Drying

Diversified Technologies Services, Inc.

Dewatering Equipment

- Studsvik, Inc

Dewatering Services

- Studsvik, Inc

Diagnostic Systems

Enertech

Wyle Laboratories, Inc.

Diagnostics

- Black & Veatch
- Energy Resources Group, Inc.
- Wyle Laboratories, Inc.

Diagnostics: Electric Machinery

- Schulz Electric Company

Diagnostics: Steam Generator

- Babcock & Wilcox Canada

Diagnostics: Valve

E.H. Wachs Co.

- Siemens Energy, Inc
- Valcor Engineering Corporation
- Wyle Laboratories, Inc.

Diagnostics: Valve Actuator

- Siemens Energy, Inc
- Valcor Engineering Corporation
- Wyle Laboratories, Inc.

Diamond Wire Sawing

Cutting Edge Services Corporation

Diaphragm Inspection

- Siemens Energy, Inc

Diaphragm Installation

- Siemens Energy, Inc

Diaphragm Maintenance

- Siemens Energy, Inc

Diesel Engine Maintenance

Engine Systems, Inc.

Diesel Engines: Overhauling

Engine Systems, Inc.

Diesel Generator Engineering Studies

Engine Systems, Inc.

Sargent & Lundy

Diesel Generators

- Black & Veatch
- Engine Systems, Inc.
- Western United Industries

Diesel Generators: Parts

Engine Systems, Inc.

- Nuclear Logistics, Inc.
- Wyle Laboratories, Inc.

Diesel Generators: Repair

- Schulz Electric Company

Diesel Generators: Repair, Safety-Related

Engine Systems, Inc.

- Schulz Electric Company

Diesel Generators: Safety-Related

Engine Systems, Inc.

Nutherm International, Inc.

Wyle Laboratories, Inc.

Distributor: OEM

Enertech

- Schulz Electric Company
- Wyle Laboratories, Inc.

Diving

- Underwater Construction Corporation

Document Conversions: Engineering

- Black & Veatch
- EXCEL Services Corporation

Documentation: Design Basis

- EXCEL Services Corporation
- The Shaw Group Inc., Nuclear Power Division

Documentation: Technical and User

- EXCEL Services Corporation





GENERAL ATOMICS ELECTRONIC SYSTEMS



RATEMETERS



ALPHA-BETA SAMPLERS



DOSIMETERS



PROCESS MONITORS

RADIATION MONITORING SYSTEMS

General Atomics Electronic Systems has over four decades of experience in design and production of qualified Radiation Monitoring Systems.



ENVIRONMENTAL
MONITORS



AREA
MONITORS

- Area Monitors
- Process Monitors
- Environmental Monitors
- Regulatory Guide 1.97 Post-Accident Monitors
- Single and Multi-Channel Processors
- Central Computer Systems
- Nuclear Safety Related Systems

General Atomics Electronic Systems offers comprehensive support throughout the entire plant lifecycle.

- Spare Parts and Repair Services
- Factory and Plant-Site Technical Service Support
- Factory and Plant-Site Training Services
- Semiannual User Group Meetings - Most Widely Recognized in Industry

In cooperation with partner RTS Instruments, General Atomics Electronic Systems offers a range of radiation detection, monitoring and analysis products with broad applications across the commercial nuclear power, DOE, environmental, research and Homeland Security markets. These products represent significant technology advances, and are designed to satisfy our customers' most demanding performance requirements.

Corporate Office

General Atomics Electronic Systems
4949 Greencraig Lane, San Diego, CA 92123
TEL: (858) 522-8360 ● FAX: (858) 522-8318
Contact: **Victor Camacho**

Represented in Korea by:

Sangjie Commercial Co., Ltd., Sang-Rock Bldg.,
1629-3 Seocho-Dong, Seocho-Ku, Seoul, Korea
TEL: 02-588-3561 ● FAX: 02-588-8772
Contact: **Mr. J. K. Shin**

Represented in Taiwan by:

O. Chiao Co., Ltd., Room 3, 6th Floor,
No. 46 Chengteh Rd., Section 2, Taipei, Taiwan, R.O.C.
TEL: 886-2-2555-9778 ● FAX: 886-2-2558-4832
Contact: **John Lin**

Represented in People's Republic of China by:

Beijing BRICEM Science and Technology Co., Ltd.
Jiukeshu 145 Tongzhou Area, Beijing, China
TEL: 010-81530483 ● FAX: 010-81530483
Contact: **Li, Shao Hai**

- Door Services**
Trentec, Inc.
- Doors: Access**
• SSM Industries, Inc.
Trentec, Inc.
- Doors: Blast**
Trentec, Inc.
- Doors: Bullet Proof**
AT&F Nuclear, Inc, Division of American Tank and Fabricating
• SSM Industries, Inc.
Trentec, Inc.
- Doors: Manway**
Scientech
Trentec, Inc.
- Doors: Marine**
• SSM Industries, Inc.
- Doors: Plenum**
• SSM Industries, Inc.
- Doors: Radiation Shielding**
• Hilman Inc.
• SSM Industries, Inc.
Trentec, Inc.
- Dosimeter Chargers**
Biodex Medical Systems
Jordan Nuclear Company
S.E. International, Inc.
- Dosimeter Readers: Automatic Pocket**
Biodex Medical Systems
• General Atomics Electronic Systems, Inc.
- Dosimeters: Alarm**
• General Atomics Electronic Systems, Inc.
- Dosimeters: Direct Reading**
Biodex Medical Systems
• Ludlum Measurements, Inc.
S.E. International, Inc.
Scientech
- Dosimeters: Electronic Pocket**
Biodex Medical Systems
• General Atomics Electronic Systems, Inc.
• Mirion Technologies
- Dosimeters: Electronic, Digital**
• General Atomics Electronic Systems, Inc.
• Mirion Technologies
- Dosimeters: Personal**
Biodex Medical Systems
• General Atomics Electronic Systems, Inc.
• Mirion Technologies
S.E. International, Inc.
Thermo Scientific
- Dosimeters: Radiation**
Berkeley Nucleonics Corp.
Biodex Medical Systems
• General Atomics Electronic Systems, Inc.
• Ludlum Measurements, Inc.
S.E. International, Inc.
Thermo Scientific
- Dosimetry Program Design**
Research Software Consulting Group, Inc.
- Dosimetry Programs**
Research Software Consulting Group, Inc.
- Dosimetry Services**
Radiation Safety Institute of Canada
- Dosimetry Services: TLD Badges**
• Mirion Technologies
- Dosimetry Supplies: TLD**
• Mirion Technologies
Thermo Scientific
- Dosimetry Systems**
• Mirion Technologies
Research Software Consulting Group, Inc.
- Dosimetry: Personnel**
Thermo Scientific
- Dosimetry: TLD Systems**
Thermo Scientific

- Drafting Services**
• Black & Veatch
- Drills**
E.H. Wachs Co.
- Drums: Polyethylene**
LANCS Industries, Inc.
- Dryers: Microwave**
Linn High Therm GmbH
- Dryers: Wet Solids**
Diversified Technologies Services, Inc.
Linn High Therm GmbH
- Drywell Head Services**
Trentec, Inc.
- Ductwork**
O'Donnell Consulting Engineers, Inc.
• SSM Industries, Inc.
- Ductwork Hangers**
• SSM Industries, Inc.
- Ductwork Supports**
• SSM Industries, Inc.
- ECC (Emergency Core Cooling) Strainers**
• Atomic Energy of Canada Limited
- Eddy Current Probes**
• Atomic Energy of Canada Limited
Interest, Inc.
• Zetec, Inc.
- Eddy Current Test Equipment**
Interest, Inc.
• Zetec, Inc.
- Eddy Current Test Standards**
Interest, Inc.
• Zetec, Inc.
- Eddy Current Testing Services**
• Babcock & Wilcox Canada
Hennigan Engineering Company, Inc.
Interest, Inc.
Laboratory Services
• Siemens Energy, Inc.
• Zetec, Inc.
- Education: Nuclear Technology Degrees**
Excelsior College
- Electrical Equipment Services**
• Schulz Electric Company
Wyle Laboratories, Inc.
- Electrical Panels: Control**
• Schulz Electric Company
• Westerman Nuclear
- Electronic Components and Equipment**
Argo Turboserve Corporation (ATC)
• DIVESCO, Inc.
Scientech
Stacosystems
- Electronic Procedures**
Scientech
- Emergency Planning**
• EXCEL Services Corporation
Scientech
- Emergency Preparedness Program Development**
• EXCEL Services Corporation
The Delphi Groupe, Inc.
• The Shaw Group Inc., Nuclear Power Division
- Emergency Preparedness Program Evaluation**
• EXCEL Services Corporation
- Emergency Preparedness: Program Audits**
• EXCEL Services Corporation
- Emergency Preparedness: Staff Support**
Bartlett Holdings, Inc.
• EXCEL Services Corporation
• G.D. Barri & Associates, Inc.
The Delphi Groupe, Inc.
- Enclosures: Metal**
LANCS Industries, Inc.
- Enclosures: Polycarbonate**
LANCS Industries, Inc.

- Engineering Services**
ABS Consulting
Advent Engineering Services, Inc.
• Atomic Energy of Canada Limited
• Babcock & Wilcox Canada
Bartlett Holdings, Inc.
Bechtel Power
Bechtel Power
• Black & Veatch
• Black & Veatch
• EXCEL Services Corporation
EXPONENT
• Flowsolve Pump Division
• Joseph Oat Corporation
• Kinectrics Incorporated
O'Donnell Consulting Engineers, Inc.
• Proto-Power Corporation
RCM Technologies, Inc.
Sargent & Lundy
Scientech
• Siemens Energy, Inc.
• Tecnatom, S.A.
• The Shaw Group Inc., Nuclear Power Division
• WorleyParsons Group, Inc.
Wyle Laboratories, Inc.
- Engineering Services: BWR**
• Black & Veatch
Enercon Services, Inc.
• EXCEL Services Corporation
• GE Hitachi Nuclear Energy
ILD, Inc.
• Proto-Power Corporation
Sargent & Lundy
Scientech
• The Shaw Group Inc., Nuclear Power Division
WMG, Inc.
- Engineering Services: PWR**
• Black & Veatch
Enercon Services, Inc.
• EXCEL Services Corporation
ILD, Inc.
• Kinectrics Incorporated
• Proto-Power Corporation
Sargent & Lundy
Scientech
• Siemens Energy, Inc.
• The Shaw Group Inc., Nuclear Power Division
WMG, Inc.
- Engineering Services: Underwater**
WMG, Inc.
- Engineering: Civil**
Enercon Services, Inc.
EXPONENT
Sargent & Lundy
- Engineering: Control**
• Proto-Power Corporation
Sargent & Lundy
- Engineering: Cost**
Sargent & Lundy
Scientech
- Engineering: Design**
Advent Engineering Services, Inc.
Bartlett Holdings, Inc.
Burns and Roe
E.H. Wachs Co.
Enercon Services, Inc.
• EXCEL Services Corporation
ILD, Inc.
• Joseph Oat Corporation
O'Donnell Consulting Engineers, Inc.
• Proto-Power Corporation
Sargent & Lundy
Scientech
The Delphi Groupe, Inc.
WM B. Johnson & Associates Inc.
- Engineering: Electrical**
Enercon Services, Inc.
EXPONENT
• Joseph Oat Corporation
• Proto-Power Corporation
Sargent & Lundy
Scientech
The Delphi Groupe, Inc.



WorleyParsons

resources & energy

EcoNomics™



32,200
Personnel

38
Countries

118
Offices

"The acquisition of Polestar significantly increases WorleyParsons' capability in the nuclear consulting and analysis segment of the international nuclear industry."

John Grill, WorleyParsons' Chief Executive Officer

Write to: NuclearServices@worleyparsons.com
for complete information.

OneWay™
to Zero Harm

The Next Generation of Global Nuclear Power Capability

Our services to the Power industry cover the full asset spectrum both in size and lifecycle – from the creation of new assets to services that sustain and improve operating assets. Our comprehensive global network of expertise and local presence, strengthened by the acquisition of Polestar Applied Technology, Inc., allows us to offer tailored solutions to our customers for nuclear power generation from compliance and operating performance to the most current safety, risk assessment, and deactivation and decommissioning standards.

EcoNomics™ - Environmental and social imperatives now affect the bottom line for all major corporations and projects globally, which are particularly challenging in the resources and energy sectors. WorleyParsons is uniquely positioned to work both globally and locally with our customers to deliver on the value of EcoNomics™. Our range of services and technologies embed environmental, social, and financial sustainability into project delivery, across the asset lifecycle.

www.worleyparsons.com

Now hiring talented engineering professionals. For more information, visit our web site at: www.worleyparsons.com/employment

- Engineering: Electronic**
WM B. Johnson & Associates Inc.
- Engineering: Environmental**
EXPONENT
Sargent & Lundy
- Engineering: Equipment**
WM B. Johnson & Associates Inc.
- Engineering: Field**
• Babcock & Wilcox Canada
- Engineering: Instrumentation**
• Data Systems & Solutions SAS
Enercon Services, Inc.
Norman N. Axelrod Associates, Optical Sensing & Control System Development Division
- Proto-Power Corporation
Sargent & Lundy
WM B. Johnson & Associates Inc.
- Engineering: Low-Level Waste Remediation**
S.M. Stoller Corp.
WMG, Inc.
- Engineering: Maintenance**
• Climax Portable Machine Tools, Inc.
• Data Systems & Solutions SAS
• EXCEL Services Corporation
Sargent & Lundy
• The Shaw Group Inc., Nuclear Power Division
- Engineering: Materials**
EXPONENT
• Joseph Oat Corporation
- O'Donnell Consulting Engineers, Inc.
Sargent & Lundy
- Engineering: Mechanical**
Design Engineering Analysis Corporation
Enercon Services, Inc.
EXPONENT
• Flowsolve Pump Division
• Holtec International
• Joseph Oat Corporation
O'Donnell Consulting Engineers, Inc.
• Proto-Power Corporation
Sargent & Lundy
Scientech
The Delphi Groupe, Inc.
- Engineering: Metallurgical**
ATI Wah Chang
EXPONENT
- Engineering: Nuclear**
AMEC NSS Limited, AMEC NCL
• AREVA Inc., AREVA NC Inc.
• Atomic Energy of Canada Limited
• Babcock & Wilcox Canada
Bechtel Power
• Black & Veatch
• EXCEL Services Corporation
• Holtec International
• Joseph Oat Corporation
• Proto-Power Corporation
Sargent & Lundy
Scientech
- The Shaw Group Inc., Nuclear Power Division
WMG, Inc.
- Engineering: Pipe Supports**
• The Shaw Group Inc., Nuclear Power Division
- Engineering: Power Uprate**
Enercon Services, Inc.
• EXCEL Services Corporation
ILD, Inc.
• Proto-Power Corporation
Sargent & Lundy
Scientech
• Siemens Energy, Inc.
• The Shaw Group Inc., Nuclear Power Division
- Engineering: Quality**
• EXCEL Services Corporation
• Proto-Power Corporation
Sonic Systems International, Inc.
- Engineering: Radiological**
Bartlett Holdings, Inc.
Millennium Services, Inc.
WMG, Inc.
- Engineering: Start-Up**
Bechtel Power
• EXCEL Services Corporation
• Siemens Energy, Inc.
- Engineering: Structural**
• Holtec International
O'Donnell Consulting Engineers, Inc.

Directory 2010

2010 Directory

Suppliers listed in the 2009 Directory will receive the 2010 Directory mailing with a list of their products and services as they appeared in the 2009 Directory.

A mailing will also be sent during the fall of 2009 to all interested suppliers who wish to list their products and services in the Product & Service Directory 2010.

All nuclear power industry suppliers who are not listed in the 2009 Directory may register for the 2010 Directory by emailing a request that includes complete contact information to:

Nuclear Plant Journal, Directory 2008 Listing Department, 799 Roosevelt Road, Building 6, Suite 208, Glen Ellyn, IL 60137-5925 USA; E-mail: NPJ@goinfo.com

Directory Policy

EQES, Inc. reserves the right of inclusion of any supplier. Listings are compiled from information submitted by suppliers. All efforts are made by *Nuclear Plant Journal* to ensure the accurate representation of the listed products

and services. EQES, Inc., the publisher of *Nuclear Plant Journal*, is not responsible for any errors or omissions in the Directory listings.

The listings and advertisements provided in this Directory should not be construed as an endorsement by *Nuclear Plant Journal* or EQES, Inc. Every purchaser should thoroughly evaluate each listed resource before making a purchasing decision.

Information included in the Directory is for the exclusive use of the purchasers in the nuclear power industry. Any other use of the Directory will constitute a violation of the copyright laws of the United States. No part of this Directory may be reproduced in any form for any purpose other than the purchase of the listed products and services.

Phone: (630) 858-6161, ext. 106

Fax: (630) 858-8787

Web Site: <http://www.NPJOnline.com>

Email: NPJ@goinfo.com

© Copyright 2009 EQES, Inc. All rights reserved.

WE MAKE METAL WORK™

THE EXPERIENCED AND RELIABLE SOURCE
FOR NUCLEAR POWER PLANT COMPONENTS



↑ A 316 stainless RHR Heat Exchanger



▲ Clean Room for the fabrication of components requiring physical segregation



↑ Commercial nuclear reactor burial cask



▲ A titanium CCW Heat Exchanger

Over 100 power plants in 15 countries rely on Joseph Oat Corporation equipment.

- 35 continuous years of maintaining ASME SEC III CL. 1, 2 and 3 "N" stamp
- NUPIC audited
- Section III and safety-related heat exchangers & pressure vessels
- Plate fin air coolers
- Reverse engineering
- Pulsation dampeners
- Filters & Strainers
- Dry storage fabrication for spent fuel
- Yucca Mountain Waste Package Prototype
- MCOs, Model 9975s & other canisters
- Special weldments
- Heat transfer design services
- Seismic analysis
- Fatigue analysis
- Spare parts & miscellaneous materials



ESTABLISHED 1788

Joseph Oat Corporation

2500 Broadway
Camden, NJ 08104 USA
Voice: 856-541-2900
Fax: 856-541-0864
email: sales@josephoat.com
www.josephoat.com

Our **Quality Assurance Program** is qualified for ASME Section III Class 1, 2, 3, and MC, and Section VIII. It also conforms to 10CFR50 Appendix B, ANSI N45.2, NQA-1 and ISO 9001.



We also hold a Chinese Safety Quality License

- Proto-Power Corporation
Sargent & Lundy
- Engineering: Systems**
Advent Engineering Services, Inc.
Bartlett Holdings, Inc.
- EXCEL Services Corporation
ILD, Inc.
- Proto-Power Corporation
Sargent & Lundy
- Enrichment Services**
- Urenco Ltd.
- Environmental Auditing**
- EXCEL Services Corporation
- Environmental Impact Assessment**
ATI Wah Chang
Enercon Services, Inc.
- EXCEL Services Corporation
EXPONENT
S.E. Logan and Associates, Inc.
- The Shaw Group Inc., Nuclear Power Division
- Urenco Ltd.
- Environmental Management**
Bartlett Holdings, Inc.
CS-2 Inc.
- EXCEL Services Corporation
EXPONENT
S.M. Stoller Corp.
- Environmental Monitoring Equipment**
- Canberra Industries, Inc.
- HI-Q Environmental Products Company
ORTEC
TechniDATA AG
- Environmental Protection Services**
- The Shaw Group Inc., Nuclear Power Division
- Environmental Qualification**
Advent Engineering Services, Inc.
Enercon Services, Inc.
Engine Systems, Inc.
- Kinectrics Incorporated
- Nuclear Logistics, Inc.
- Nutherm International, Inc.
- Proto-Power Corporation
RCM Technologies, Inc.
Sargent & Lundy
- Schulz Electric Company
Scientech
- The Shaw Group Inc., Nuclear Power Division
Trentec, Inc.
- WorleyParsons Group, Inc.
Wyle Laboratories, Inc.
- Environmental Remediation**
American DND Inc.
Bartlett Holdings, Inc.
Eberline Services Inc.
Fuel Tank Maintenance Company LLC
- The Shaw Group Inc., Nuclear Power Division
- Environmental Restoration**
- The Shaw Group Inc., Nuclear Power Division
- Environmental Services**
Eberline Services Inc.
EXPONENT
- The Shaw Group Inc., Nuclear Power Division
- Environmental Test Chambers**
LANCS Industries, Inc.
- Equipment & Services: Chromate Removal**
Diversified Technologies Services, Inc.
- Equipment & Services: Reverse Osmosis**
Diversified Technologies Services, Inc.
- Equipment & Services: Silica Removal**
Diversified Technologies Services, Inc.
- Equipment Design**
E.H. Wachs Co.
Hydratight
- Joseph Oat Corporation
Wyle Laboratories, Inc.
- Equipment Qualification**
Enercon Services, Inc.
- Kinectrics Incorporated
- Nuclear Logistics, Inc.
- Sargent & Lundy
- Schulz Electric Company

- Scientech
- Trentec, Inc.
- Wyle Laboratories, Inc.
- Equipment Qualification: Components, ASME**
ABS Consulting
- Kinectrics Incorporated
Scientech
- Trentec, Inc.
- Valcor Engineering Corporation
- Westerman Nuclear
- Equipment Reliability**
Scientech
- Equipment Replacement**
- Black & Veatch
- Nuclear Logistics, Inc.
- Schulz Electric Company
Scientech
- Westerman Nuclear
Wyle Laboratories, Inc.
- Equipment: Bullet Resisting**
AT&F Nuclear, Inc, Division of American Tank and
Fabricating
- Equipment: Intrinsically Safe**
Cygnus Instruments Inc.
- Equipment: Mechanical**
- DIVESCO, Inc.
Hydratight
- Nuclear Logistics, Inc.
Trentec, Inc.
- Wyle Laboratories, Inc.
- Equipment: Safety-Related**
AT&F Nuclear, Inc, Division of American Tank and
Fabricating
- Data Systems & Solutions SAS
Draeger Safety.Inc.
Enertech
- Joseph Oat Corporation
- Nuclear Logistics, Inc.
Nutherm International, Inc.
Precision Custom Components, LLC
- Schulz Electric Company
Scientech
Southern Testing Services, a Division of ATC
Spectrum Technologies, a Division of ATC
- SSM Industries, Inc.
Trentec, Inc.
- Westerman Nuclear
Wyle Laboratories, Inc.
- Erosion Ultrasonic Testing Surveys**
Interrest, Inc
- Evaporators**
- Joseph Oat Corporation
TRANTER
- Exhibition Management**
- WM Symposia,
- Expediting Services**
- DIVESCO, Inc.
- Eye/Face Protection**
Biodex Medical Systems
- Fabrication: Tubular Products**
AT&F Nuclear, Inc, Division of American Tank and
Fabricating
ATI Wah Chang
Energy & Process Corporation
- Trust Manufacturing
- Fabrications**
ALFAB, Inc.
AT&F Nuclear, Inc, Division of American Tank and
Fabricating
Energy & Process Corporation
- Joseph Oat Corporation
- Nuclear Logistics, Inc.
- Penn Iron Works, Inc.
Precision Custom Components, LLC
Scientech
- SSM Industries, Inc.
Tioga Pipe Supply Company Inc.
Trentec, Inc.
- Trust Manufacturing
Welding Services Inc.
- Westerman Nuclear
- Fabrics: Flame Retardant**

- Euclid Garment Manufacturing Company
- Herculite Products
LANCS Industries, Inc.
- UniTech Services Group, Inc., Div. of Unifirst Corp.
- Fabrics: Incinerable**
Herculite Products
LANCS Industries, Inc.
- UniTech Services Group, Inc., Div. of Unifirst Corp.
- Fabrics: Silica**
LANCS Industries, Inc.
- Failure Analysis**
ABS Consulting
- Atomic Energy of Canada Limited
EXPONENT
Herguth Laboratories
- Kinectrics Incorporated
Laboratory Services
Sargent & Lundy
- Schulz Electric Company
Wyle Laboratories, Inc.
- Failure Analysis: Electron Microscopy**
- Atomic Energy of Canada Limited
EXPONENT
Herguth Laboratories
- Kinectrics Incorporated
Laboratory Services
- Fan Analysis**
Howden UK Ltd
- Fans: Axial**
- Nuclear Logistics, Inc.
- SSM Industries, Inc.
Wyle Laboratories, Inc.
- Fans: Centrifugal**
- Nuclear Logistics, Inc.
- SSM Industries, Inc.
Wyle Laboratories, Inc.
- Fans: Exhaust**
- SSM Industries, Inc.
- Fans: High-Pressure**
- SSM Industries, Inc.
- Fans: Ventilating**
Nutherm International, Inc.
- SSM Industries, Inc.
- Fasteners**
HellermannTyton
Niagara Fasteners Inc.
Tioga Pipe Supply Company Inc.
- Trust Manufacturing
- Fasteners: Stud Tensioning**
- Trust Manufacturing
- Feedthroughs: Fiber-Optic**
- Mirion Technologies
- Feedwater Heaters**
- Holtec International
- Joseph Oat Corporation
TRANTER
Welding Services Inc.
- Fiber Optics**
HellermannTyton
Interrest, Inc
Weed Instrument
- Fibrescopes: Rad Hardened**
Interrest, Inc
- Mirion Technologies
- Field Service**
AMETEK Programmable Power, Supporting Elgar
Nuclear Equip.
Enertech
Flowserve Flow Control Division
- GE Hitachi Nuclear Energy
Powerfect
- Schulz Electric Company
- Siemens Energy, Inc
Wyle Laboratories, Inc.
- Films: Vacuum Metallized**
Alexander Vacuum Research, Inc.
- Filter Cartridge**
- HI-Q Environmental Products Company



Our enrichment technology provides a whole new momentum.

Our uranium enrichment technology is a revolutionary force in the nuclear fuel cycle. As the cleanest and most energy-efficient technology, it provides a sustainable energy supply for nuclear power which helps ensure security of supply and affordability. In so doing, it ensures nuclear energy is a viable option as part of a balanced energy mix.

As an independent energy and technology group with global leadership in centrifuge technology, Urenco is ideally placed to give a reliable and flexible source of support to the nuclear industry.

www.urencocom

urencocom
Enriching the future

Filter Consolidators

Ionex Research Corp.

Filter Elements

- AAF International
- Croll-Reynolds Engineering Company Inc.
- Mott Corporation

Filter Housings

- AAF International
- HI-Q Environmental Products Company
- SSM Industries, Inc.
- Tri Nuclear Corporation

Filter Media

- Diversified Technologies Services, Inc.
- HI-Q Environmental Products Company
- Mott Corporation

Filter Paper

- HI-Q Environmental Products Company

Filter Refills

- AAF International

Filter Systems

- AAF International
- Croll-Reynolds Engineering Company Inc.
- NUCON International, Inc.
- Tri Nuclear Corporation

Filter Systems: Portable HEPA

- NUCON International, Inc.

Filter Testing

- NUCON International, Inc.

Filters

- AAF International
- Joseph Oat Corporation
- Mott Corporation
- Tri Nuclear Corporation

Filters: Absolute Rated

- AAF International

Filters: Activated Carbon

- AAF International
- HI-Q Environmental Products Company
- NUCON International, Inc.

Filters: Air

- AAF International

Filters: Air Sampler

- HI-Q Environmental Products Company
- Mirion Technologies
- Staplex-Air Sampler Division

Filters: ASME Code

- AAF International

Filters: Backwash

Croll-Reynolds Engineering Company Inc.
Diversified Technologies Services, Inc.
Mott Corporation

Filters: Bag

- AAF International

Filters: Charcoal

- AAF International

Filters: Condensate Polishing

Croll-Reynolds Engineering Company Inc.
Mott Corporation

Filters: Disposable

- AAF International

Filters: Gas

- AAF International
- Mott Corporation
- NUCON International, Inc.

Filters: HEPA

- AAF International
- Blue Lake Products
- Ionex Research Corp.
- LANCS Industries, Inc.

Filters: Liquid

Croll-Reynolds Engineering Company Inc.
Diversified Technologies Services, Inc.
Mott Corporation
Tri Nuclear Corporation

Filters: Metal Mesh

Newark Wire Cloth Company
Tri Nuclear Corporation

Filters: Pleated

- AAF International
- Newark Wire Cloth Company

Filters: Porous Metal

Mott Corporation

Filters: Precoat

Croll-Reynolds Engineering Company Inc.

Filters: Pressure

Croll-Reynolds Engineering Company Inc.

Filters: Radwaste

- AAF International
- Croll-Reynolds Engineering Company Inc.
- Tri Nuclear Corporation

Filters: Reactor Containment Vent

- AAF International

Filters: Sintered Metal Fiber

Mott Corporation

Filters: Tubular Element

Croll-Reynolds Engineering Company Inc.
Diversified Technologies Services, Inc.

Filters: Ultra

Blue Lake Products

Filters: Underwater

Diversified Technologies Services, Inc.
Tri Nuclear Corporation

- Underwater Construction Corporation

Filtration

Mott Corporation
Tri Nuclear Corporation

Filtration Equipment

- AAF International
- Ionex Research Corp.
- Mott Corporation
- NUCON International, Inc.
- SSM Industries, Inc.
- Tri Nuclear Corporation

AAF INTERNATIONAL

From HEPAs to Housings

AAF is the Leader in Nuclear Power Plant Air Filtration and Cooling

AstroCel® III
2000 CFM Nuclear HEPA

- ASME AG-1 Qualified
- Extend Life
- Increase Capacity
- Reduce Footprint
- Reduce Replacement Costs
- Reduce Disposal Costs

Installations in over 90% of Nuclear Facilities in North America

- Prefilters
- HEPA Filters
- Carbon Filters
- Coils
- Filter Houses
- Air Handlers

Call 502.637.0279 or email nuclear@aafintl.com

Historical NPJ Cover

Nuclear Plant Safety

Volume 2 No. 1
An EDES Publication
January-February 1984

January-February 1984
Volume 2, Issue 1

Analysis of burnup data using color, graphics and mathematical techniques.
IBM

Filtration Media: Carbon

- AAF International
- HI-Q Environmental Products Company

Fire Proofing Materials

Arch Wood Protection, Inc

Fire Protection

- Black & Veatch
- EXCEL Services Corporation
- EXPONENT
- Proto-Power Corporation
- Scientech

Fire Protection: Electrical Systems

Euclid Garment Manufacturing Company

Fittings

- McNichols Company
- Newage Industries, Inc.
- Nuclear Logistics, Inc.
- Scientech
- Trust Manufacturing

Fittings: Flow Control

Scientech

Fittings: Welding

- Trust Manufacturing
- Westerman Nuclear

Flanges

- Energy & Process Corporation
- Tioga Pipe Supply Company Inc.
- Trust Manufacturing

Flow Measurement Services

Air Monitor Corp.

Flowmeters

- Air Liquide America Specialty Gases, LLC
- HI-Q Environmental Products Company
- Nuclear Logistics, Inc.
- Wyle Laboratories, Inc.

Flowmeters: Mass

- HI-Q Environmental Products Company

Foil: LeadBiodex Medical Systems
LANCS Industries, Inc.**Foils: High-Purity Metal**

ATI Wah Chang

Forging Copper

- Trust Manufacturing

Forging Copper Alloy

- Trust Manufacturing

Forgings

- Energy & Process Corporation
- Tioga Pipe Supply Company Inc.
- Trust Manufacturing

Forgings: Open Die

- Trust Manufacturing

Foundation Design & Analysis

Sargent & Lundy

Fuel Analysis

- Atomic Energy of Canada Limited
- GE Hitachi Nuclear Energy
- Holtec International
- R&G Laboratories, Inc

Fuel Assemblies

Zircatec Precision Industries Inc.

Fuel Assembly Grids

IMI Components Ltd.

Fuel Assembly Nozzles

IMI Components Ltd.

Fuel Casks: BargePrecision Custom Components, LLC
Rigging International**Fuel Casks: Rail**Precision Custom Components, LLC
Rigging International

TRUST Manufacturing
(trúst) n.: firm reliance on integrity, ability, and character

Fasteners
For All Safety
Related Applications
Deliveries You Can Trust
Rush Deliveries Welcome

216.531.8787
www.trustmfg.com sales@trustmfg.com
20080 St. Clair Ave Cleveland, Ohio 44117-1015, USA

NPJ Delivers More!**Highest Circulation**

Nuclear Plant Journal's current circulation reaches more than 12,000 qualified recipients, including more than 4,600 utility recipients--the highest among U.S. publications targeted to the nuclear power industry. *Nuclear Plant Journal's* circulation is audited by BPA.

Buy 2009 Advertising Space at 2008 Rates

Advertisers whose commitments are received before January 28, 2009 will be billed at the 2008 rates for 2009 advertising.

Nuclear Plant Journal

Phone: (630) 858-6161, ext. 103

Fax: (630) 858-8787

<http://www.NPJOnline.com>E-mail: NPJ@goinfo.com

Fuel Channels

- Atomic Energy of Canada Limited
- Kinectrics Incorporated

Fuel Consolidation Equipment
Scientech

Fuel Examination

- Atomic Energy of Canada Limited
- GE Hitachi Nuclear Energy

Fuel Fabrication

Zircatec Precision Industries Inc.

Fuel Floor Support

Sonic Systems International, Inc.
WMG, Inc.

Fuel Handling Equipment

- ANSALDO NUCLEARE SPA
- Atomic Energy of Canada Limited
- Joseph Oat Corporation
- Morris Material Handling (P&H)
- Precision Custom Components, LLC
- Scientech

Fuel Inspection

- Atomic Energy of Canada Limited
- Sonic Systems International, Inc.

Fuel Management

- AREVA Inc., AREVA NC Inc.

Fuel Pool Cleanup

- PTP Spent Fuel Services, LLC.
- Tri Nuclear Corporation
- Underwater Construction Corporation
- WMG, Inc.

Fuel Pool Equipment

- Holtec International
- Trentec, Inc.
- WMG, Inc.

Fuel Pool Liners

- Underwater Construction Corporation

Fuel Positioning Systems

Morris Material Handling (P&H)

Fuel Rack Disposal

- Holtec International
- Studsvik, Inc

Fuel Storage Facilities

- Precision Custom Components, LLC
- Rigging International
- Scientech
- The Shaw Group Inc., Nuclear Power Division

Fuel Storage Racks

- Holtec International
- Precision Custom Components, LLC
- Underwater Construction Corporation

Fuel Transfer System Maintenance

Morris Material Handling (P&H)
Scientech

Fuel Transfer Systems

- Hilman Inc.
- Holtec International
- Morris Material Handling (P&H)
- Scientech
- Underwater Construction Corporation

Fuel: BWR

- GE Hitachi Nuclear Energy

Fuel: Spent, Transport

- Holtec International
- Morris Material Handling (P&H)
- PTP Spent Fuel Services, LLC.
- WMG, Inc.

Fuel: Transport Flasks

Precision Custom Components, LLC

Fuse Holders: Safety-Related

- Kinectrics Incorporated
- Nuclear Logistics, Inc.
- Nutherm International, Inc.
- Scientech
- Trentec, Inc.
- Wyle Laboratories, Inc.

Fuses: Safety-Related

- Kinectrics Incorporated
- Nuclear Logistics, Inc.
- Nutherm International, Inc.
- Scientech
- Trentec, Inc.
- Wyle Laboratories, Inc.

Gases: Specialty

Air Liquide America Specialty Gases, LLC

Gaskets: Radiation Resistant

- Pawling Engineered Products
- Seal Master Corporation
- Trentec, Inc.
- Wyle Laboratories, Inc.

Gauges: Force

Wyle Laboratories, Inc.

Gauges: Pressure

- Nuclear Logistics, Inc.
- Scientech
- Trentec, Inc.
- Wyle Laboratories, Inc.

Gauges: Strain

SOLTEC Corporation

Gauges: Ultrasonic Thickness

Cygnus Instruments Inc.
Intertest, Inc

Gauges: Ultrasonic Thickness, Portable

Intertest, Inc

Gauges: Vacuum

Scientech
Wyle Laboratories, Inc.

Generator Boresonic Examination

- Intertest, Inc
- Siemens Energy, Inc

Generator Inspection

- Schulz Electric Company
- Siemens Energy, Inc

Generator Maintenance

- Siemens Energy, Inc

Generators

- Siemens Energy, Inc
- Western United Industries

Glove Bags

LANCS Industries, Inc.

Glove Boxes

- Container Products Corporation
- LANCS Industries, Inc.
- Precision Custom Components, LLC
- SSM Industries, Inc.

Gloves: Protective

- Biodex Medical Systems
- Euclid Garment Manufacturing Company
- UniTech Services Group, Inc., Div. of Unifirst Corp.

Grating

McNichols Company

Grease Analysis

Herguth Laboratories
R&G Laboratories, Inc
Scientech

Grills

Scientech

Grit Blasting

- Schulz Electric Company
- UniTech Services Group, Inc., Div. of Unifirst Corp.

Handhole Repair Services

- Babcock & Wilcox Canada
- Hydratight

Hatch Services

Hydratight
Trentec, Inc.

Health & Safety Services

CS-2 Inc.
Quality Inspection Services, Inc

Health Physics

- EXCEL Services Corporation
- LANCS Industries, Inc.
- Ludlum Measurements, Inc.
- Millennium Services, Inc.

Plant Profiles and Cover Pictures

Would you like to have your plant's profile in the next issue of *Nuclear Plant Journal*? Would you like to have your plant's photo on the cover? Please submit candidate profiles and photographs to:

Nuclear Plant Journal
799 Roosevelt Road
Building 6, Suite 208
Glen Ellyn, IL 60137
Phone: (630) 858-6161, ext. 101
Fax: (630) 858-8787
E-mail: NPJ@goinfo.com

See Grand Gulf's profile on pg. 117.

**Nuclear
Plant
Journal**

**www.
NPJOnline.
com**

www.NPJOnline.com

- Pacific Radiation Corporation
- The Delphi Groupe, Inc.
- The Shaw Group Inc., Nuclear Power Division
- Health Physics Data Systems**
- Canberra Industries, Inc.
- Health Physics Services**
- Applied Consultants, Inc.
- Bartlett Holdings, Inc.
- Eberline Services Inc.
- Pacific Radiation Corporation
- Scientech
- UniTech Services Group, Inc., Div. of Unifirst Corp.
- Health Physics Supplies**
- Apco Extruders Inc.
- Canberra Industries, Inc.
- Coastal Network, Inc.
- Euclid Garment Manufacturing Company
- HI-Q Environmental Products Company
- LANCS Industries, Inc.
- Mohawk Industrial & Nuclear Supply, Inc.
- UniTech Services Group, Inc., Div. of Unifirst Corp.
- Heat Decay Studies**
- Black & Veatch
- Heat Exchanger Analysis/Inspection Services**
- Babcock & Wilcox Canada
- Black & Veatch
- Holtec International
- IHI Southwest Technologies, Inc.
- Joseph Oat Corporation
- Powerfect
- Proto-Power Corporation
- Heat Exchanger Maintenance**
- Bartlett Holdings, Inc.
- Hennigan Engineering Company, Inc.
- Hydratight
- Plastacor, Inc.
- Powerfect
- TRANTER
- Welding Services Inc.



**Your On-Line
Nuclear Safety Checklist!**

- Health Physics & Decon Supplies
- Test Wipe Smears & Filter Paper
- Anti-C Gloves & Shoecovers
- Lead Shielding
- Bags, Tubing & Sleeving
- Signs, Labels & Tapes
- Containment Chambers & Tents
- Anti-C Clothing

Free Catalog Upon Request!

**Call 800-394-6853 or
Order On-line!**

5 Glen Road, Manchester, CT 06040
MohawkSafety.com



UltraWipe perfects microfiber technology to provide a cleaning wiper specifically developed for nuclear applications. Decon performance is remarkable, but just as important, **UltraWipe** offers outstanding service life with excellent contaminant release in laundering.

- Proven decon factors
- High absorption capacity
- Lauanders well
- Floor accessories available



What is Microfiber?

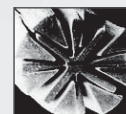

Microfiber is a synthetic filament with one denier diameter (1/30 of cotton). Wedge shaped elements follow the surface, trapping particles inside the fiber. Capillary effect between the filaments promotes very high absorbency.

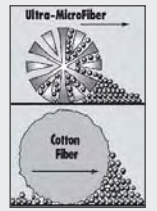

**OFFERING A FULL LINE OF
DISCOUNTED HP SUPPLIES**

(800) 344-3824 • www.shopunitech.ws

Heat Exchanger Tube Cleaning
Hennigan Engineering Company, Inc.
Powerfect

Heat Exchanger: Chemical Cleaning
Hennigan Engineering Company, Inc.

- Heat Exchangers**
- Aerofin Corporation
 - Aerofin Corporation
 - AT&F Nuclear, Inc, Division of American Tank and Fabricating
 - Babcock & Wilcox Canada
 - Black & Veatch
 - Black & Veatch
 - Holtec International
 - Joseph Oat Corporation
 - Joseph Oat Corporation
 - Lytron
 - Lytron
 - Nuclear Logistics, Inc.
 - Precision Custom Components, LLC

Thermal Engineering International
TRANTER
TRANTER

- Westerman Nuclear
- Westerman Nuclear

- Heat Exchangers: Rebuilding**
- Aerofin Corporation
 - ATI Wah Chang
 - Holtec International
 - Joseph Oat Corporation
 - Powerfect

- Heat Exchangers: Retubing**
- Aerofin Corporation
 - ATI Wah Chang
 - Holtec International

- Heat Exchangers: Shell**
- Aerofin Corporation
 - Holtec International
 - Joseph Oat Corporation

- Westerman Nuclear

- Heat Exchangers: Studies**
- Black & Veatch
 - Holtec International
 - Joseph Oat Corporation
 - Proto-Power Corporation

- Heat Exchangers: Tubes**
- ATI Wah Chang
 - Lytron
 - Valtime Inc.
 - Westerman Nuclear

- Heat Tracing Systems**
- Nuclear Logistics, Inc.
 - Wyle Laboratories, Inc.

- Heat Treating**
- Hydratight

- Heaters: Electric**
- Linn High Therm GmbH
 - Power House Tool, Inc.
 - Wyle Laboratories, Inc.

- Heating Equipment: Electric Resistance**
- Linn High Therm GmbH
 - Power House Tool, Inc.

- Heating Equipment: Induction**
- Hydratight
 - Linn High Therm GmbH

- Heavy Water**
- Atomic Energy of Canada Limited

- Hoists**
- American Crane & Equipment Corp.
 - Black & Veatch
 - Morris Material Handling (P&H)
 - Scientech

- Hoists: Radio Controls**
- American Crane & Equipment Corp.
 - Morris Material Handling (P&H)

- Hoods: Respirator**
- Euclid Garment Manufacturing Company
 - LANCIS Industries, Inc.
 - UniTech Services Group, Inc., Div. of Unifirst Corp.

- Hose**
- LANCIS Industries, Inc.
 - Newage Industries, Inc.
 - Seal Master Corporation

- Hose Assemblies: Metal**
- Nuclear Logistics, Inc.
 - Scientech

- Hose Assemblies: Plastic**
- Newage Industries, Inc.
 - Sonic Systems International, Inc.

- Hot Cell Services**
- Atomic Energy of Canada Limited
 - GE Hitachi Nuclear Energy

- Housings: Filter**
- AAF International
 - Tri Nuclear Corporation

- Humidity Measuring Equipment**
- Elan Technical Corporation

- HVAC Construction**
- Black & Veatch
 - SSM Industries, Inc.

- HVAC Systems**
- Black & Veatch
 - Nuclear Logistics, Inc.
 - Sargent & Lundy
 - The Shaw Group Inc., Nuclear Power Division
 - Wyle Laboratories, Inc.

- HVAC Systems: Acceptance Testing**
- NUCON International, Inc.

- HVAC Systems: AG-1 Testing**
- NUCON International, Inc.
 - Nutherm International, Inc.

- HVAC Systems: Installation**
- SSM Industries, Inc.

- HVAC Systems: Start-Up Testing**
- NUCON International, Inc.

- HVAC Systems: Testing**
- NUCON International, Inc.

Safety Related Coils and Heat Exchangers

AEROFIN is Your Source for Safety Related & Non-Safety Related Components

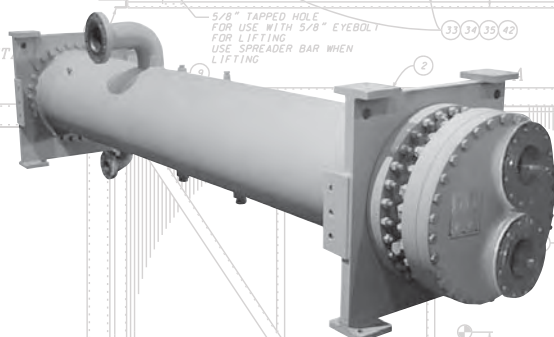

- Cooling & Heating Coils
- Shell & Tube Heat Exchangers
- Pressure Vessels
- Air Accumulator Tanks
- Pressurizer Sample Coolers
- Lube Oil Coolers
- Transformer Oil Coolers
- Piping Subassemblies
- Specialty Fabricated Parts
- Evaporators & Condensers
- Automatic Water Strainers

AEROFIN is fully accredited to meet your nuclear equipment needs.

- NUPIC audited
- 10CFR50 Appendix B
- 10CFR21 Reportability
- ASME NQA-1 / NCA-4000
- ASME Section III
- ASME Section VIII
- ASME AG-1 CONAGT
- Reverse Engineering

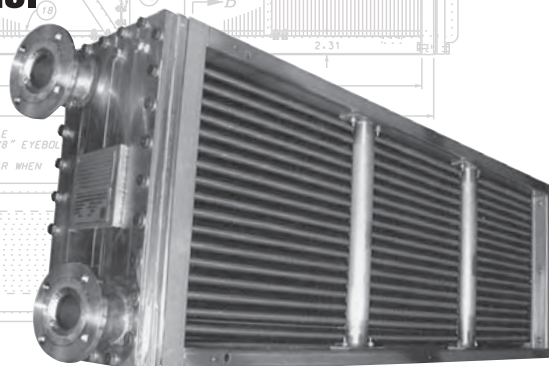

4621 Murray Place (24502) • P.O. Box 10819
Lynchburg, VA 24506-0819
Phone: 434-845-7081 • Fax: 434-528-6281
www.aerofin.com • Phone Toll Free: 1-800-237-6346



NUCON[®] Nuclear HVAC Products and Services

10CFR50 Appendix B and NQA-1 QA Program • Licensed Radioisotope Laboratory

SYSTEMS and COMPONENTS

- **Complete ESF and non-ESF Air Treatment**
- **Portable Air Cleaning Units (P-NATS)**
- **Type II Adsorber Trays and Type III Adsorber Units**
- **Adsorber Refilling Services of Type II trays and Type I cells**

ANSI/ASME N510 TESTING INSTRUMENTS

- **Tracer Gas Detectors and Generators (R-11, R-12, R-112 and R-112A, HCFC-123, R-134a, 1-Bromobutane)**
- **Aerosol Detectors and Generators (DOR, PAO, DOS)**
- **Pressure Detectors**

RADIOIODINE ADSORBENTS

- **Replacement Adsorbents: NUSORB[®] Brands KITEG[™] II and TEG[™](Regulatory Guides 1.52 & 1.140, ANSI/ASME N509 and ASME AG-1)**

RADIOISOTOPE TESTING LABORATORY

- **New and Used Carbon Radioiodine Performance Testing (Regulatory Guides 1.52 & 1.140, ASTM D3803, RDT-M16-1T, DIN, DNR)**
- **¹³³Xe/⁸⁵Kr Dynamic "K" Testing**

ON-SITE SERVICES

- **In-Place Leak Testing (ANSI/ASME N510)**
- **Control Room Habitability Improvements and Upgrades**
- **Control Room Envelope In-Leakage Testing (ASTM E741)**
- **Duct Leakage Testing**
- **Compliance Review of ESF Systems (Regulatory Guides and Technical Specifications)**
- **Air Balancing (NEBB)**
- **Acceptance Testing (ANSI/ASME N510 and ASME AG-1)**
- **Personnel Training (Regulatory Guides, ANSI/ASME Standards, and ASTM Methods)**

LABORATORY and ENGINEERING SERVICES

- **Radioisotope "Heat Decay" Studies**
- **Chemical Effects Studies (paints, coatings, solvents)**
- **Calibration Services (Halide and Aerosol Equipment, Airflow Measuring Instruments)**
- **HVAC System Design**



NUCON[®] International, Inc

**7000 Huntley Road
Columbus, Ohio 43229
Phone: 614-846-5710**

Fax: 614-431-0858

Web: www.nucon-int.com

HVAC: Ventilation Equipment

- AAF International
Bartlett Holdings, Inc.
- Nuclear Logistics, Inc.
- SSM Industries, Inc.
Trentec, Inc.
Wyle Laboratories, Inc.

Hydraulic Equipment

- Climax Portable Machine Tools, Inc.
E.H. Wachs Co.
Hydratight
J&R Engineering Company, Inc.

Hydrogen Removal/Purification Devices

- Atomic Energy of Canada Limited

Hygrometers

- Elan Technical Corporation

I&C Cable Systems: IE Qualified

- Meggitt Safety Systems

I/O Controllers

- Black & Veatch
Scientech
Stacosystems

I/O Systems: Distributed

- Black & Veatch

Image Intensifier: Neutron

- Thermo Fisher Scientific, Scientific Instrument Division
CIDTEC Cameras & Imagers

Image Recognition Systems

- Mirion Technologies

Imaging Systems

- RMD Instrument Corp
- Thermo Fisher Scientific, Scientific Instrument Division
CIDTEC Cameras & Imagers
Unitron, Ltd

Incinerable Products

- Reef Industries, Inc.
- UniTech Services Group, Inc., Div. of Unifirst Corp.

Indicator Lights: Safety-Related

- Nutherm International, Inc.
Scientech
Trentec, Inc.
Wyle Laboratories, Inc.

Indicators

- Nuclear Logistics, Inc.
Scientech
Trentec, Inc.
Wyle Laboratories, Inc.

Indicators: Panel Mounted

- Nuclear Logistics, Inc.
Scientech
Trentec, Inc.
Wyle Laboratories, Inc.

Industrial Hygiene Services

EXPONENT

Industrial Hygiene: Program Evaluation

EXPONENT

Information Management Systems

- Black & Veatch
- EXCEL Services Corporation
Sargent & Lundy
Scientech

Information Services

Scientech

Information Services: Equipment Qualification

- Nutherm International, Inc.
Scientech
Wyle Laboratories, Inc.

Information Services: Inspection Enforcement

- EXCEL Services Corporation
Scientech

Infrared Surveys: Electrical

- Schulz Electric Company

Inspection

EXPONENT

- GE Hitachi Nuclear Energy
- Siemens Energy, Inc
- Sonic Systems International, Inc.
- The Shaw Group Inc., Nuclear Power Division

Inspection Equipment: Development

- Kinectrics Incorporated
R. Brooks Associates, Inc.
- Siemens Energy, Inc
- Tecnatom, S.A.
- Thermo Fisher Scientific, Scientific Instrument Division
CIDTEC Cameras & Imagers

Inspection Equipment: Robotic

- Atomic Energy of Canada Limited
Hennigan Engineering Company, Inc.
Interstest, Inc
R. Brooks Associates, Inc.
- Siemens Energy, Inc
- Tecnatom, S.A.

Inspection Equipment: Visual

- Interstest, Inc
- Mirion Technologies
R. Brooks Associates, Inc.
- R. Brooks Associates, Inc.
- Siemens Energy, Inc
- Tecnatom, S.A.
- Thermo Fisher Scientific, Scientific Instrument Division
CIDTEC Cameras & Imagers

Inspection Materials: Dye Penetrant

- Interstest, Inc
- Siemens Energy, Inc

Inspection Procedure Validation

- Tecnatom, S.A.

Inspection Services

- American Crane & Equipment Corp.
Bartlett Holdings, Inc.
- EXCEL Services Corporation
EXPONENT
Hennigan Engineering Company, Inc.
IHI Southwest Technologies, Inc.
Interstest, Inc
Powerfect
R. Brooks Associates, Inc.
- Schulz Electric Company
- Tecnatom, S.A.
- Underwater Construction Corporation

Inspection: Balance-of-Plant

- Interstest, Inc
R. Brooks Associates, Inc.
Sonic Systems International, Inc.

Inspection: Equipment

- Interstest, Inc
R. Brooks Associates, Inc.
- Schulz Electric Company

Inspection: Feedwater Nozzle

R. Brooks Associates, Inc.

Inspection: In-Service

- IHI Southwest Technologies, Inc.
International Quality Consultants, Inc.
Interstest, Inc
R. Brooks Associates, Inc.
Sargent & Lundy
Sonic Systems International, Inc.

Inspection: In-Vessel

- Interstest, Inc
R. Brooks Associates, Inc.

Inspection: Pipeline

- Hennigan Engineering Company, Inc.
R. Brooks Associates, Inc.

Inspection: Pressure Vessel

- IHI Southwest Technologies, Inc.
Interstest, Inc
R. Brooks Associates, Inc.

Inspection: Primary-Side Components

- Atomic Energy of Canada Limited
R. Brooks Associates, Inc.

Inspection: Quality Control

- International Quality Consultants, Inc.
Sonic Systems International, Inc.

Inspection: Reactor Internals

- R. Brooks Associates, Inc.
Sonic Systems International, Inc.

Inspection: Remote

- Interstest, Inc
R. Brooks Associates, Inc.
R. Brooks Associates, Inc.

Inspection: Secondary Side Components

- Interstest, Inc
R. Brooks Associates, Inc.

Inspection: Steam Generator

- Atomic Energy of Canada Limited
- Babcock & Wilcox Canada
Interstest, Inc
- Kinectrics Incorporated
R. Brooks Associates, Inc.

Inspection: Vessel Welds, BWR

- IHI Southwest Technologies, Inc.
Interstest, Inc
Sonic Systems International, Inc.

Inspections: Underwater

- Interstest, Inc
R. Brooks Associates, Inc.
Sonic Systems International, Inc.
- Underwater Construction Corporation

Installation: Fuel Rack

- Underwater Construction Corporation

Installation: Mechanical

- Bartlett Holdings, Inc.
Welding Services Inc.

Installation: Piping

- Welding Services Inc.

Installation: Setup

- Bartlett Holdings, Inc.

Instrument Power Supplies

- Nuclear Logistics, Inc.
Scientech
Wyle Laboratories, Inc.

Instrument Racks: Seismic Multibay

- Thermo Scientific, Part of Thermo Fisher Scientific,
Process Instruments Div.

Instrument Signal Isolation Devices

- Scientech
Thermo Scientific, Part of Thermo Fisher Scientific,
Process Instruments Div.
Trentec, Inc.

Instrument Weatherhouses

- HI-Q Environmental Products Company

Instrumentation

- Black & Veatch
- Data Systems & Solutions SAS
Enertech
- Mirion Technologies
- Nuclear Logistics, Inc.
Scientech
Trentec, Inc.

Instrumentation Cabinets

- Data Systems & Solutions SAS
Trentec, Inc.

Instrumentation/Control System Calibration

- Data Systems & Solutions SAS
- EXCEL Services Corporation
- G.D. Barri & Associates, Inc.
- Tecnatom, S.A.

Instrumentation/Control System Maintenance

- Data Systems & Solutions SAS
- Tecnatom, S.A.

Instrumentation/Control Systems

- Acromag, Inc.
Air Monitor Corp.
Argo Turboserve Corporation (ATC)
- Black & Veatch
- Data Systems & Solutions SAS
- DIVESCO, Inc.
Norman N. Axelrod Associates, Optical Sensing &
Control System Development Division
- Proto-Power Corporation
Scientech
- Siemens Energy, Inc
Southern Testing Services, a Division of ATC
Spectrum Technologies, a Division of ATC

Instrumentation/Control Systems: Class 1E

- Black & Veatch
- Data Systems & Solutions SAS
- Kinectrics Incorporated
- Nuclear Logistics, Inc.
Nutherm International, Inc.
Scientech

OUR EXPERTS KNOW IT ALL!



NUCLEAR KNOWLEDGE

Our advanced nuclear capabilities include:

- Equipment Qualification – Seismic Testing
- Nuclear Parts – Commercial Grade
Dedication Reverse Engineering
- Nuclear Waste Management
- Radioactive Materials Lab
- Radiochemistry
- Tritium Management - Process
and Plant System Design
- Concrete Repair and Rehabilitation
- Inspection Tool Development

In today's nuclear environment not only is it essential to have comprehensive technical knowledge but, to know how to apply it in order to maintain and support this valuable energy source.

For more information contact us at:
www.kinectrics.com



LIFE CYCLE MANAGEMENT SOLUTIONS



- Siemens Energy, Inc
Thermo Scientific, Part of Thermo Fisher Scientific,
Process Instruments Div.
Trentec, Inc.
Valcor Engineering Corporation

Instrumentation/Control Systems: Repair

- Data Systems & Solutions SAS
Scientech
- Siemens Energy, Inc

Instrumentation/Control: Part Replacement

- Black & Veatch
- Data Systems & Solutions SAS
- DIVESCO, Inc.
- Nuclear Logistics, Inc.
Scientech
- Siemens Energy, Inc

Instrumentation: Electrical Troubleshooting

- Data Systems & Solutions SAS
Trentec, Inc.

Instrumentation: Health Physics

- Canberra Industries, Inc.
- HI-Q Environmental Products Company
- Mirion Technologies
ORTEC
WM B. Johnson & Associates Inc.

Instrumentation: Monitoring Environmental

- General Atomics Electronic Systems, Inc.
Staplex-Air Sampler Division

Instrumentation: Nuclear

- Atomic Energy of Canada Limited
- Black & Veatch
- Canberra Industries, Inc.
- Data Systems & Solutions SAS
- GE Hitachi Nuclear Energy
- General Atomics Electronic Systems, Inc.
- HI-Q Environmental Products Company
- Mirion Technologies
- RMD Instrument Corp
Scientech
Thermo Scientific, Part of Thermo Fisher Scientific,
Process Instruments Div.

- Valcor Engineering Corporation
WM B. Johnson & Associates Inc.

Instrumentation: Packless

- Valcor Engineering Corporation

Instrumentation: Process Control

- Data Systems & Solutions SAS
- Mirion Technologies
Scientech

Instrumentation: Radiation Protection

- Canberra Industries, Inc.
- Mirion Technologies
Thermo Scientific
WM B. Johnson & Associates Inc.

Instrumentation: Seismic

- Wyle Laboratories, Inc.

Instrumentation: Specialized

- Data Systems & Solutions SAS
- Norman N. Axelrod Associates, Optical Sensing &
Control System Development Division

Instrumentation: Tritium

- HI-Q Environmental Products Company

Instrumentation: Vibration

- Wyle Laboratories, Inc.

Instruments

- Mirion Technologies
Scientech

Instruments: Aerosol Leak Detection

- NUCON International, Inc.

Instruments: Air Velocity

- HI-Q Environmental Products Company

Instruments: Contamination Monitoring

- Canberra Industries, Inc.
- HI-Q Environmental Products Company
- Mirion Technologies
S.E. International, Inc.

Instruments: Electronic

- Homeland-Defense 4 U, Inc.
Scientech
Wyle Laboratories, Inc.

Instruments: Halide Leak Detection

- NUCON International, Inc.

Instruments: Humidity Measurement

- Elan Technical Corporation

Instruments: Metal Sorting

- Intertest, Inc
Thermo Scientific, Niton Analyzers

Instruments: Meteorological

- Murray and Trettel, Inc.

Instruments: Portable Survey

- Biodex Medical Systems
Jordan Nuclear Company
- Ludlum Measurements, Inc.
- Mirion Technologies
S.E. International, Inc.
WM B. Johnson & Associates Inc.

Instruments: Safety-Related

- Black & Veatch
- Data Systems & Solutions SAS
- Mirion Technologies
- Nuclear Logistics, Inc.
Nuthern International, Inc.
Scientech
Wyle Laboratories, Inc.

Instruments: Temperature Measuring

- SOLTEC Corporation
Wyle Laboratories, Inc.

Insulation Materials

- Reef Industries, Inc.

Insulation: Thermal

- Performance Contracting Inc. (PCI)

Intrusion Detection Systems

- Vulnerability Assessment Team, Argonne National
Laboratory

UNITED STATES POSTAL SERVICE®

Statement of Ownership, Management, and Circulation (Requester Publications Only)

1. Publication Title Nuclear Plant Journal	2. Publication Number 08922055	3. Filing Date September 12, 2008
4. Issue Frequency Bi-monthly	5. Number of Issues Published Annually 2	6. Annual Subscription Price (if any) US\$160.00
7. Complete Mailing Address of Known Office of Publication (Not printer) (Street, city, county, state, and ZIP+4®) 799 Roosevelt Road, Building 6, Suite 208, Glen Ellyn, IL 60137-5925		Contact Person Newal K. Agnihotri Telephone (include area code) (630) 858-6161
8. Complete Mailing Address of Headquarters or General Business Office of Publisher (Not printer) Same as above		
9. Full Names and Complete Mailing Addresses of Publisher, Editor, and Managing Editor (Do not leave blank)		
Publisher (Name and complete mailing address) Newal K. Agnihotri 799 Roosevelt Rd, Bldg 6, Ste 208, Glen Ellyn, IL 60137-5925		
Editor (Name and complete mailing address) Same as above		
Managing Editor (Name and complete mailing address) Same as above		
10. Owner (Do not leave blank. If the publication is owned by a corporation, give the name and address of the corporation immediately followed by the names and addresses of all stockholders owning or holding 1 percent or more of the total amount of stock; if not owned by a corporation, give the names and addresses of the individual owners. If owned by a partnership or other unincorporated firm, give its name and address as well as those of each individual owner. If the publication is published by a nonprofit organization, give its name and address.)		
Full Name	Complete Mailing Address	
Newal K. Agnihotri	799 Roosevelt Road Building 6, Suite 208 Glen Ellyn, IL 60137-5925	
11. Known Bondholders, Mortgagees, and Other Security Holders Owning or Holding 1 Percent or More of Total Amount of Bonds, Mortgages, or Other Securities. If none, check box <input checked="" type="checkbox"/> None		
Full Name	Complete Mailing Address	
12. Tax Status (For completion by nonprofit organizations authorized to mail at nonprofit rates) (Check one)		
<input type="checkbox"/> Has Not Changed During Preceding 12 Months		
<input type="checkbox"/> Has Changed During Preceding 12 Months (Publisher must submit explanation of change with this statement)		

PS Form 3526-R, September 2007 (Page 1 of 3 (Instructions Page 3)) PSN: 7530-09-000-8355 PRIVACY NOTICE: See our privacy policy on www.usps.com

13. Publication Title Nuclear Plant Journal	14. Issue Date for Circulation Data Below Sept/Oct 2008	
15. Extent and Nature of Circulation	Average No. Copies Each Issue During Preceding 12 Months	No. Copies of Single Issue Published Nearest to Filing Date
a. Total Number of Copies (Net press run)	12555	12457
b. Legitimate Paid and/or Requested Distribution (By Mail and Outside the Mail)		
(1) Outside County Paid/Requested Mail Subscriptions stated on PS Form 3541. (Include direct written request from recipient, telemarketing and Internet request from recipient, paid subscriptions including nominal rate subscriptions, employer requests, advertiser's proof copies, and exchange copies.)	6292	6706
(2) In-County Paid/Requested Mail Subscriptions stated on PS Form 3541. (Include direct written request from recipient, telemarketing and Internet request from recipient, paid subscriptions including nominal rate subscriptions, employer requests, advertiser's proof copies, and exchange copies.)	0	0
(3) Sales Through Dealers and Carriers, Street Vendors, Counter Sales, and Other Paid or Requested Distribution Outside USPS®	0	0
(4) Requested Copies Distributed by Other Mail Classes Through the USPS (e.g. First-Class Mail®)	0	0
c. Total Paid and/or Requested Circulation (Sum of 15b (1), (2), (3), and (4))	6292	6706
d. Non-requested Distribution (By Mail and Outside the Mail)		
(1) Outside County Nonrequested Copies Stated on PS Form 3541 (include Sample copies, Requests Over 3 years old, Requests Induced by a Premium, Bulk Sales and Requests Including Association Requests, Names obtained from Business Directories, Lists, and other sources)	6263	5751
(2) In-County Nonrequested Copies Stated on PS Form 3541 (include Sample copies, Requests Over 3 years old, Requests Induced by a Premium, Bulk Sales and Requests Including Association Requests, Names obtained from Business Directories, Lists, and other sources)	0	0
(3) Nonrequested Copies Distributed Through the USPS by Other Classes of Mail (e.g. First-Class Mail, Nonrequestor Copies mailed in excess of 10% Limit mailed at Standard Mail® or Package Services Rates)	0	0
(4) Nonrequested Copies Distributed Outside the Mail (Include Pickup Stands, Trade Shows, Showrooms and Other Sources)	0	0
e. Total Nonrequested Distribution (Sum of 15d (1), (2), (3) and (4))	6263	5751
f. Total Distribution (Sum of 15c and e)	12555	12457
g. Copies not Distributed (See Instructions to Publishers #4, (page #3))	220	243
h. Total (Sum of 15f and g)	12775	12700
i. Percent Paid and/or Requested Circulation (15c divided by f times 100)	50.11%	53.83%
NOV/DEC 2008		
16. Publication of Statement of Ownership for a Requester Publication is required and will be printed in the issue of this publication.		
17. Signature and Title of Editor, Publisher, Business Manager, or Owner Newal K. Agnihotri, PUBLISHER		Date 10/6/08
I certify that all information furnished on this form is true and complete. I understand that anyone who furnishes false or misleading information on this form or who omits material or information requested on the form may be subject to criminal sanctions (including fines and imprisonment) and/or civil sanctions (including civil penalties).		
PS Form 3526-R, September 2007 (Page 2 of 3)		



How to power this place?

We want the best of both worlds. A world full of light and power. But a world that's also clean and healthy. The answer lies in efficient energy solutions that reduce CO₂ emissions and save natural resources. We put a lot of energy into getting the balance right - for you, for the environment, for our future.

www.siemens.com/energy

Answers for energy.

SIEMENS

*TEC...your partner on
the road to smooth
plant operation*



*Working with a proven company can give
you the confidence to operate your plant
more efficiently and avoid unexpected and
costly downtime.*

*You can depend on TEC to make your work
go more smoothly.*

*safety relief valve monitoring (active and passive)
signal isolation*

*loose part monitoring and impact trending
materials testing products and services*

TEC providing superior measurement
and analysis products and services

10737 Lexington Drive, Knoxville, TN 37932
865/966-5856 or Fax 865/675-1241
www.tec-usa.com

*TEC's QA program meets the requirements of 10CFR Part 50,
Appendix B, and 10CFR Part 21.*

Inventory Management

- Argo Turboserve Corporation (ATC)
- DIVESCO, Inc.
- Sciencetech
- Trust Manufacturing

Inventory Tracking Systems

Sciencetech

Inverters

AMETEK Programmable Power, Supporting Elgar Nuclear Equip.

- Nuclear Logistics, Inc.
- Nutherm International, Inc.
- Wyle Laboratories, Inc.

Investigations: Accident

Conger & Elsea, Inc.
EXPONENT

- Kinectrics Incorporated

Investigations: Event

Conger & Elsea, Inc.

- EXCEL Services Corporation
- EXPONENT

Investigations: Incident

Conger & Elsea, Inc.

- EXCEL Services Corporation
- EXPONENT
- Human and Organizational Performance Improvement

Investigations: Pre-Employment Screening

Bartlett Holdings, Inc.

Investigations: unescorted Access Screenings

PPS Access Screening

Ion Exchange Equipment

Diversified Technologies Services, Inc.

Ion Exchange Media

Diversified Technologies Services, Inc.
Epicor, Inc.

Ion Exchange Resins

Epicor, Inc.

- Kinectrics Incorporated
- Resintech, Inc.

Irradiation Services

Atlantic Nuclear Services Ltd.
MDS Nordion

Isolators: Analog Signal

Sciencetech

- Technology for Energy Corporation (TEC)

Isolators: Digital Signal

Sciencetech

- Technology for Energy Corporation (TEC)

Joints: Expansion

Croll-Reynolds Engineering Company Inc.

- Siemens Energy, Inc

Lab Analysis: Environmental

ATI Wah Chang

- Kinectrics Incorporated

Lab Analysis: Ground Water

ATI Wah Chang

Lab Analysis: Mixed Waste

ATI Wah Chang

Lab Analysis: Radiological

ATI Wah Chang

- Canberra Industries, Inc.
- Eberline Services Inc.
- Herguth Laboratories
- Kinectrics Incorporated

Lab Research: Materials

ATI Wah Chang

- Atomic Energy of Canada Limited
- EXPONENT
- Kinectrics Incorporated

Labels

Euclid Garment Manufacturing Company
HellermannTyton
Uticom Systems Inc.

Labels: Bar Coded

Infosight Corp.
Uticom Systems Inc.

Labels: Warning

Biodex Medical Systems
Uticom Systems Inc.

Labor Management

- Siemens Energy, Inc

Laboratory Services

- ATI Wah Chang
- EXPONENT
- Herguth Laboratories
- Laboratory Services
- Mass Spec Services
- Northeast Technology Corp.
- Wyle Laboratories, Inc.

Lapping Machines

- Climax Portable Machine Tools, Inc.
- Siemens Energy, Inc

Lapping Services

- Siemens Energy, Inc

Lathes: Transportable

- Climax Portable Machine Tools, Inc.
- E.H. Wachs Co.
- Hydratight
- Siemens Energy, Inc

Laundry Services

- UniTech Services Group, Inc., Div. of Unifirst Corp.

Laundry: Water Wash

- UniTech Services Group, Inc., Div. of Unifirst Corp.

Lead Paint Abatement Equipment

- Fuel Tank Maintenance Company LLC
- Pentek Decontamination Products DIV.
- Thermo Scientific, Niton Analyzers
- Warrington, Inc.

Lead Shielding Refurbishment

- LANCS Industries, Inc.

Lead Shielding: New

- Biodex Medical Systems

Leak Detection Equipment

- Cygnus Instruments Inc.
- Enertech
- Hennigan Engineering Company, Inc.
- NUCON International, Inc.
- Trentec, Inc.

Leak Detection Services

- Hennigan Engineering Company, Inc.
- Powerfect
- Underwater Construction Corporation

Leak Detection: Acoustic

- Underwater Construction Corporation

Leak Rate Testing

- Trentec, Inc.

Licensing Support Services

- Advent Engineering Services, Inc.
- CTR Technical Services, Inc.
- EXCEL Services Corporation
- EXPONENT
- NPTS, Inc.
- Proto-Power Corporation
- RCM Technologies, Inc.
- Sargent & Lundy
- Scientech
- The Shaw Group Inc., Nuclear Power Division
- Wyle Laboratories, Inc.

Licensing: Safety

- AMEC NSS Limited, AMEC NCL

Licensing: Technical Specifications

- CTR Technical Services, Inc.
- EXCEL Services Corporation
- Scientech

Life Extension

- Black & Veatch
- Enertech
- EXCEL Services Corporation
- EXPONENT
- Sargent & Lundy
- Scientech
- The Shaw Group Inc., Nuclear Power Division
- Wyle Laboratories, Inc.

Life Extension: Plant

- Bechtel Power
- EXCEL Services Corporation
- Scientech
- Siemens Energy, Inc

Life Extension: Plant, BWR

- Black & Veatch
- EXCEL Services Corporation
- Scientech

Lifting: Heavy

- American Crane & Equipment Corp.
- Black & Veatch
- Morris Material Handling (P&H)
- Western Sling And Supply Company

Lighting

- Birns, Inc.
- Black & Veatch

Lights: Underwater

- Birns, Inc.
- Lights, Camera, Action LLC

Limit Switches Counters

- Wyle Laboratories, Inc.

Liners

- ALFAB, Inc.
- Fuel Tank Maintenance Company LLC
- Reef Industries, Inc.

Logic System: Class 1E

- Data Systems & Solutions SAS
- Wyle Laboratories, Inc.

Loose Part Monitoring Systems

- Technology for Energy Corporation (TEC)

Loose Part Retrieval

- R. Brooks Associates, Inc.

Louvers

- SSM Industries, Inc.

Lubrication Analysis

- Herguth Laboratories
- R&G Laboratories, Inc

Machine Shop: Portable

- Climax Portable Machine Tools, Inc.
- Hydratight

Directory Directions

Features

The Directory is a source of information on resources for over 3,000 products and services related to the nuclear power industry. The information included in the Directory was submitted by approximately 300 suppliers worldwide in October and November 2008.

The Products & Services section includes listings of available current products and services with the names of the related suppliers. Items listed in the Directory are related to the nuclear power industry only. Therefore, the words “nuclear” or “nuclear power” have been dropped from certain product and service terms.

The modified noun approach has been used for several terms. For example,

Corrosion Monitoring Software has been listed as “Software: Corrosion Monitoring.” “Airborne Radioactivity Monitoring Systems” has been listed as “Monitoring Systems: Airborne Radioactivity.”

Each supplier’s listing in the Suppliers section includes complete contact information.

Telephone numbers outside of the United States are listed as submitted by the Directory participants. The caller may need to add the proper country and city codes to make the telephone or fax number complete.

The bullets before individual suppliers in the Products & Services section and in the Suppliers section denote an advertiser in the Directory.

The page number of each advertisement is shown in the List of Advertisers on Page 8 and also in the Suppliers section immediately following the supplier’s contact information.

Corporate Capabilities

The Corporate Capabilities section lists products and services of organizations in one central location. Supplier contact information is also provided in this section. A “\$” symbol before the contact information in the Suppliers section indicates that the organization has a listing in the Corporate Capabilities section. A list of Corporate Capabilities participants is provided on Page 107.

Phone: (630) 858-6161, ext. 106

Fax: (630) 858-8787

E-mail: NPJ@goinfo.com

Web Site: www.NPJOnline.com

Machines: Grinding

- Climax Portable Machine Tools, Inc. Hydratight

Machines: Milling

- Climax Portable Machine Tools, Inc. E.H. Wachs Co. Hydratight
- Penn Iron Works, Inc.

Machining

- Climax Portable Machine Tools, Inc. Energy & Process Corporation Hydratight
- IMI Components Ltd. Major Tool & Machine, Inc. Penn Iron Works, Inc. Precision Custom Components, LLC
- Schulz Electric Company
- Trust Manufacturing
- Westerman Nuclear

Machining Centers: Field

- Climax Portable Machine Tools, Inc. Hydratight

Machining: BWR Remote

- Advanced Consulting Group, Inc. Hydratight

Machining: Compressors

- Hydratight Precision Custom Components, LLC

Machining: Coupling

- Climax Portable Machine Tools, Inc. Hydratight
- Siemens Energy, Inc

Machining: Diaphragm

- Hydratight

Machining: Flanges

- Climax Portable Machine Tools, Inc. E.H. Wachs Co. Hydratight
- Siemens Energy, Inc
- Trust Manufacturing

Machining: Gear Box

- Hydratight

Machining: Generators

- Climax Portable Machine Tools, Inc. Hydratight
- Precision Custom Components, LLC

Machining: Heat Exchanger

- Climax Portable Machine Tools, Inc. Hydratight
- Precision Custom Components, LLC
- Westerman Nuclear

Machining: Journals

- Climax Portable Machine Tools, Inc. Hydratight
- Schulz Electric Company
- Siemens Energy, Inc

Machining: Motors

- Schulz Electric Company
- Siemens Energy, Inc

Machining: Nozzle

- Climax Portable Machine Tools, Inc. Hydratight
- Siemens Energy, Inc

Machining: Onsite

- Climax Portable Machine Tools, Inc. E.H. Wachs Co. Hydratight
- Siemens Energy, Inc

Machining: Pumps

- Flowserve Pump Division Hydratight
- Precision Custom Components, LLC

Machining: Remote

- Hydratight

Machining: Rotor

- Precision Custom Components, LLC
- Schulz Electric Company
- Siemens Energy, Inc

Machining: Rotor Bore

- Schulz Electric Company
- Siemens Energy, Inc

Machining: Safety-Related

- Hydratight
- Nutherm International, Inc. Precision Custom Components, LLC
- Schulz Electric Company
- Trentec, Inc.

Machining: Seals

- Climax Portable Machine Tools, Inc.
- Flowserve Pump Division Hydratight
- Seal Master Corporation
- Siemens Energy, Inc
- Trust Manufacturing

Machining: Stud Removal

- Climax Portable Machine Tools, Inc. Hydratight

Machining: Thread Milling

- Trust Manufacturing

Machining: Turbine

- Climax Portable Machine Tools, Inc. Hydratight
- Precision Custom Components, LLC

Machining: Underwater

- Hydratight
- Underwater Construction Corporation

Machining: Valve

- Climax Portable Machine Tools, Inc. Hydratight
- Siemens Energy, Inc

Magnetic Particle Equipment

- Siemens Energy, Inc

Maintenance

- Data Systems & Solutions SAS
- Day & Zimmermann Power Services Hydratight
- Schulz Electric Company



• Professionalism
 • Service
 • Trust
 • Commitment...
for the life of your plant

More than 90% of **US Nuclear Power Plants** rely on the leading company for underwater services - **Underwater Construction Corporation. UCC** has over a 35 year history of providing quality professional underwater services. **This amounts to a lifetime of nuclear experience.**

No other underwater services company can match our experience, professionalism, or commitment to supporting the industry's need to deliver cost-effective energy to its customers. We're in this for the long haul - for the life of your plant.

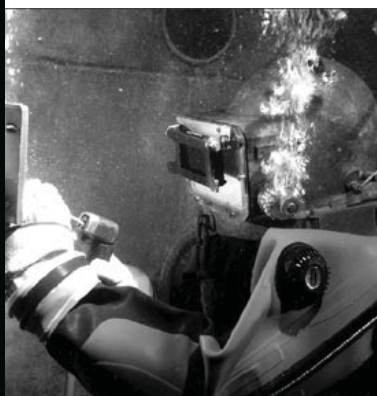

Underwater Construction Corporation
 800-USA-DIVE
 www.uccdive.com

Historical NPJ Cover



May-June 1983
 Volume 1, Issue 3

Control room man-machine interface of central plant information system.
 Northeast Utilities

Machining, re-imagined.

Throughout the world, Climax is opening new horizons in the service and life expectancy of power plants.

Recently we helped one plant achieve huge savings in shutdown costs by cutting turbine upgrades from twelve days to three. We're helping the nuclear industry make inaccessible repairs via remote control, quickly and safely. And our training institute is helping service companies counter the attrition of their expert machinists.

Imagine the possibilities. To explore how Climax on-site tools, custom engineering, consultation and training can help you minimize outages, extend plant life and make your up-rate processes more efficient – call us today.



CLIMAX®
Portable Machine Tools, Inc.

Bringing the solution to you.

NPI-SBU-0908

Worldwide Tel: +1-503-538-2185

For more information, including a list of our 23 worldwide distributors, go to www.cpmt.com

Maintenance • Materials: Qualified

- Siemens Energy, Inc
- The Shaw Group Inc., Nuclear Power Division

Maintenance Management Systems

- Data Systems & Solutions SAS
- EXCEL Services Corporation
- Sargent & Lundy
- Siemens Energy, Inc

Maintenance Program Evaluation

- Advent Engineering Services, Inc.
- Data Systems & Solutions SAS
- EXPONENT
- Sargent & Lundy
- Siemens Energy, Inc

Maintenance Services

- Atomic Energy of Canada Limited
- Bartlett Holdings, Inc.
- Data Systems & Solutions SAS
- Day & Zimmermann Power Services
- Enertech
- Flowserve Pump Division
- Hydratight
- Sargent & Lundy
- Schulz Electric Company
- Siemens Energy, Inc
- The Shaw Group Inc., Nuclear Power Division

Maintenance Services: Offsite

- Data Systems & Solutions SAS
- Schulz Electric Company
- Siemens Energy, Inc

Maintenance Services: Underwater

- Underwater Construction Corporation

Maintenance Support

- Bartlett Holdings, Inc.
- G.D. Barri & Associates, Inc.
- Mirion Technologies
- Schulz Electric Company
- Wyle Laboratories, Inc.

Maintenance Systems: Robotic

- Siemens Energy, Inc

Maintenance: Condenser

- Hennigan Engineering Company, Inc.
- Powerfect
- Siemens Energy, Inc

Maintenance: Electronics

- Data Systems & Solutions SAS

Maintenance: Equipment

- Data Systems & Solutions SAS
- E.H. Wachs Co.
- Flowserve Pump Division
- Hydratight
- Minuteman International, Inc.
- Power House Tool, Inc.
- Schulz Electric Company
- Siemens Energy, Inc
- Welding Services Inc.
- Wyle Laboratories, Inc.

Maintenance: HEPA Systems

- Minuteman International, Inc.
- UniTech Services Group, Inc., Div. of Unifirst Corp.

Maintenance: Predictive

- Data Systems & Solutions SAS
- Herguth Laboratories
- Mirion Technologies
- Morris Material Handling (P&H)
- Sargent & Lundy
- Schulz Electric Company
- Siemens Energy, Inc

Maintenance: Preventive

- Data Systems & Solutions SAS
- Herguth Laboratories
- Mirion Technologies
- Sargent & Lundy
- Schulz Electric Company
- Siemens Energy, Inc

Maintenance: Reliability Centered

- Data Systems & Solutions SAS
- EXCEL Services Corporation
- EXPONENT
- Sargent & Lundy

- Schulz Electric Company
- Scientech

Maintenance: Valves

- Babcock & Wilcox Canada
- Bartlett Holdings, Inc.
- Climax Portable Machine Tools, Inc.
- Enertech
- EXPONENT
- Flowserve Flow Control Division
- Siemens Energy, Inc

Management: Construction

- Black & Veatch
- Sargent & Lundy
- The Shaw Group Inc., Nuclear Power Division

Manifolds

- Valcor Engineering Corporation

Manifolds: Packless Globe and Instrumentation

- Valcor Engineering Corporation

Manufacturing Services

- Babcock & Wilcox Canada
- Schulz Electric Company
- Trentec, Inc.

Manway Closure Services

- Scientech
- Trentec, Inc.

Manway Cover Handling System

- Scientech

Markers: Fiber Optic

- Uticom Systems Inc.

Markers: Industrial

- Infosight Corp.
- J.P. Nissen Company
- Uticom Systems Inc.

Material Control and Accountability

- Valnerability Assessment Team, Argonne National Laboratory

Material: ASME Code

- AT&F Nuclear, Inc, Division of American Tank and Fabricating

- Black & Veatch
- Joseph Oat Corporation
- Precision Custom Components, LLC
- Trentec, Inc.
- Trust Manufacturing

Materials Characterization

- EXPONENT
- Norman N. Axelrod Associates, Optical Sensing & Control System Development Division

- Westerman Nuclear
- WMG, Inc.

Materials Handling Equipment

- American Crane & Equipment Corp.
- Hilman Inc.
- Modern Equipment Company, Inc.
- Morris Material Handling (P&H)
- Scientech
- Serapid
- Western Sling And Supply Company

Materials Handling Equipment: Rollers

- Hilman Inc.
- Serapid

Materials Management

- Black & Veatch
- Scientech

Materials Services: BWR

- EXPONENT

Materials Testing Equipment

- Engine Systems, Inc.
- EXPONENT
- Quality Inspection Services, Inc
- Technology for Energy Corporation (TEC)

Materials: Qualified

- Performance Contracting Inc. (PCI)
- Schulz Electric Company
- Southern Testing Services, a Division of ATC
- Spectrum Technologies, a Division of ATC
- Trentec, Inc.
- Trust Manufacturing
- Westerman Nuclear
- Wyle Laboratories, Inc.

MOVE THE HEAVYWEIGHTS!



HILMAN ROLLERS

WWW.HILMANROLLERS.COM

toll free (North America): 1-888-2-ROLL-IT

e-mail: sales@hilmanrollers.com





TEMPORARY & PERMANENT SKIDDING SOLUTIONS FOR NUCLEAR WASTE HANDLING

Customers rely on you to
power their world.

We make sure your plants
deliver on that promise.

**Optimize your plant lifecycle with our
Managed Maintenance SolutionsSM**

Your customers depend on you to deliver – all day, every day. With our newly expanded full-service offering, Day & Zimmermann is equipped to deliver the unsurpassed value you expect. Our suite of Managed Maintenance SolutionsSM encompasses plant maintenance and modifications, major construction projects, professional staffing, and valve, condenser, and radiological services. We're focused on optimizing your plant operations, and accelerating your success where it counts most: with your customers.

www.dayzim.com

Safety, Integrity, Diversity, Success



Day&Zimmermann

We do what we say.[®]

Measurement Services

- Technology for Energy Corporation (TEC)
Wyle Laboratories, Inc.

Measurement Systems

- Mirion Technologies
R. Brooks Associates, Inc.

Measurement Systems: Photogrammetric

- R. Brooks Associates, Inc.

Metal Fabrication

- ALFAB, Inc.
AT&F Nuclear, Inc, Division of American Tank and
Fabricating

- ATI Wah Chang
Container Products Corporation
Energy & Process Corporation

- Joseph Oat Corporation
Major Tool & Machine, Inc.
Penn Iron Works, Inc.
- Performance Contracting Inc. (PCI)
Precision Custom Components, LLC
Scientech

- SSM Industries, Inc.
Trentec, Inc.
- Trust Manufacturing
Westerman Nuclear

Metal Fabrication: Aluminum

- Container Products Corporation
- Joseph Oat Corporation
Scientech
- SSM Industries, Inc.
- Trust Manufacturing

Metal Fabrication: Nickel & Nickel Alloy

- ATI Wah Chang
Penn Iron Works, Inc.
Scientech
- SSM Industries, Inc.
- Trust Manufacturing
Westerman Nuclear

Metal Fabrication: Stainless Steel

- ALFAB, Inc.
AT&F Nuclear, Inc, Division of American Tank and
Fabricating

- Container Products Corporation
- Joseph Oat Corporation
Penn Iron Works, Inc.
Precision Custom Components, LLC
Scientech
- SSM Industries, Inc.
- Trust Manufacturing
Westerman Nuclear

Metal Fabrication: Steel

- ALFAB, Inc.
Container Products Corporation
- Joseph Oat Corporation
Penn Iron Works, Inc.
Precision Custom Components, LLC
Scientech
- SSM Industries, Inc.
- Trust Manufacturing
Westerman Nuclear

Metal Fabrication: Titanium

- AT&F Nuclear, Inc, Division of American Tank and
Fabricating

- ATI Wah Chang
- Joseph Oat Corporation
Precision Custom Components, LLC
Scientech
- Trust Manufacturing

Metal Facing

- Precision Custom Components, LLC

Metal: Alloy

- ATI Allvac
ATI Wah Chang

Metal: Alloy Bar

- ATI Allvac
ATI Wah Chang
- Trust Manufacturing

Metal: Alloy Plate

- ATI Wah Chang
- Trust Manufacturing

Metal: Expanded

- McNichols Company
- Trust Manufacturing

Metal: High-Temperature

- ATI Wah Chang
- Trust Manufacturing

Metal: Perforated

- McNichols Company
- Trust Manufacturing

Metallizing

- Schulz Electric Company

Metallography

- ATI Wah Chang
- Atomic Energy of Canada Limited
Unitron, Ltd

Meters: Air Mass Flow

- HI-Q Environmental Products Company

Meters: Air Velocity

- HI-Q Environmental Products Company

Meters: Conductivity

- International Thermal Instrument Corporation

Meters: Digital Survey

- Biodex Medical Systems
- Ludlum Measurements, Inc.

Meters: Electrical

- Nuclear Logistics, Inc.
Wyle Laboratories, Inc.

Meters: Gas Flow

- Westerman Nuclear

Meters: Radiation Survey

- Biodex Medical Systems
- Ludlum Measurements, Inc.
- Mirion Technologies
S.E. International, Inc.
WM B. Johnson & Associates Inc.

Meters: Radiography Survey

- Ludlum Measurements, Inc.
WM B. Johnson & Associates Inc.

Meters: Radon

- Mirion Technologies

Meters: Safety-Related

- Engine Systems, Inc.
Nutherm International, Inc.

Meters: Survey

- Ludlum Measurements, Inc.
- Mirion Technologies

Meters: Survey, Geiger-Mueller

- Biodex Medical Systems
- Ludlum Measurements, Inc.
- Mirion Technologies
WM B. Johnson & Associates Inc.

Meters: Survey, Neutron

- Ludlum Measurements, Inc.
- Mirion Technologies

Microscopes

- Unitron, Ltd

Microscopes: Remote

- Unitron, Ltd

Microscopy: Scanning Electron

- Laboratory Services

Mock-Ups

- Design Assistance Corporation

Modeling: Plant Systems

- Black & Veatch
Enercon Services, Inc.
- Proto-Power Corporation
Sargent & Lundy
Scientech

Modeling: Plume

- Black & Veatch

Modeling: Process

- Black & Veatch

Models: Equipment

- Black & Veatch
Morris Material Handling (P&H)

Models: Heat Exchanger

- Black & Veatch
- Proto-Power Corporation

Models: HVAC Systems

- Black & Veatch
- Proto-Power Corporation

Models: Planning Layout

- Black & Veatch
Design Assistance Corporation

Models: Power Plant

- Black & Veatch
Design Assistance Corporation
- Proto-Power Corporation

Models: Power Plant, Database

- Black & Veatch
- Proto-Power Corporation

Models: Site

- Black & Veatch

Models: Thermal Hydraulic System

- Black & Veatch
Enercon Services, Inc.
- Proto-Power Corporation

Modifications

- Black & Veatch
- Day & Zimmermann Power Services
- NPTS, Inc.
RCM Technologies, Inc.
Sargent & Lundy
- The Shaw Group Inc., Nuclear Power Division
Trentec, Inc.
Wyle Laboratories, Inc.

Moisture Separator Modification

- Black & Veatch
Thermal Engineering International

Moisture Separators

- Black & Veatch
Thermal Engineering International

Monitoring Systems

- Black & Veatch
- General Atomics Electronic Systems, Inc.
Logic Beach Inc.
- Mirion Technologies
Overhoff Technology Corporation

Monitoring Systems: Airborne Radioactivity

- Canberra Industries, Inc.
- General Atomics Electronic Systems, Inc.
- HI-Q Environmental Products Company
- Mirion Technologies

Monitoring Systems: Environmental Radiation

- HI-Q Environmental Products Company
TechniDATA AG

Monitoring Systems: Gas

- General Atomics Electronic Systems, Inc.

Monitoring Systems: Neutron

- Data Systems & Solutions SAS
- Ludlum Measurements, Inc.
Thermo Scientific, Part of Thermo Fisher Scientific,
Process Instruments Div.

Monitoring Systems: Neutron Flux

- Data Systems & Solutions SAS
- Mirion Technologies
Thermo Scientific, Part of Thermo Fisher Scientific,
Process Instruments Div.

Monitoring Systems: Plant Safety

- Data Systems & Solutions SAS
Scientech

Monitoring Systems: Reactor Vessel Level

- Data Systems & Solutions SAS

Monitoring Systems: Remote

- Bartlett Holdings, Inc.
Logic Beach Inc.
- Mirion Technologies
Norman N. Axelrod Associates, Optical Sensing &
Control System Development Division
- Siemens Energy, Inc

Monitoring Technologies: Condition

- Herguth Laboratories

Monitoring: Air

- General Atomics Electronic Systems, Inc.
- HI-Q Environmental Products Company
- Mirion Technologies
Staplex-Air Sampler Division

Monitoring: Environmental Radiological

- Eberline Services Inc.
- General Atomics Electronic Systems, Inc.
- HI-Q Environmental Products Company

Monitoring: Equipment, BWR

- GE Hitachi Nuclear Energy
- Mirion Technologies

Monitoring: Groundwater

S.M. Stoller Corp.

Monitoring: Motor Load

- Schulz Electric Company

Monitoring: Neutron

- Data Systems & Solutions SAS
- Ludlum Measurements, Inc.
- Mirion Technologies

Monitoring: Radiation

- Apantec LLC
- General Atomics Electronic Systems, Inc.
- HI-Q Environmental Products Company
- LND, Inc.
- Ludlum Measurements, Inc.
- Mirion Technologies
- TechniDATA AG
- WM B. Johnson & Associates Inc.

Monitoring: Water

- General Atomics Electronic Systems, Inc.

Monitors

R. Brooks Associates, Inc.

Monitors: Air

- Canberra Industries, Inc.
- ENMET Corporation
- General Atomics Electronic Systems, Inc.
- HI-Q Environmental Products Company
- Mirion Technologies

Monitors: Alpha

- Canberra Industries, Inc.
- General Atomics Electronic Systems, Inc.
- HI-Q Environmental Products Company
- LND, Inc.
- Mirion Technologies
- WM B. Johnson & Associates Inc.

Monitors: Area

- General Atomics Electronic Systems, Inc.
- HI-Q Environmental Products Company
- LND, Inc.
- Ludlum Measurements, Inc.
- Mirion Technologies

Monitors: Area Radiation

- Apantec LLC
- Biodex Medical Systems
- General Atomics Electronic Systems, Inc.
- HI-Q Environmental Products Company
- Jordan Nuclear Company
- LND, Inc.
- Ludlum Measurements, Inc.
- Mirion Technologies
- WM B. Johnson & Associates Inc.

Monitors: Beta

- General Atomics Electronic Systems, Inc.
- Ludlum Measurements, Inc.
- Mirion Technologies

Monitors: Contamination

- Mirion Technologies

Monitors: Dose Rate

- General Atomics Electronic Systems, Inc.
- Mirion Technologies
- Thermo Scientific, Part of Thermo Fisher Scientific, Process Instruments Div.

Monitors: Environmental

- HI-Q Environmental Products Company

Monitors: Gamma

- General Atomics Electronic Systems, Inc.
- Jordan Nuclear Company
- LND, Inc.
- Ludlum Measurements, Inc.
- Mirion Technologies
- Overhoff Technology Corporation
- S.E. International, Inc.
- Thermo Scientific, Part of Thermo Fisher Scientific, Process Instruments Div.
- WM B. Johnson & Associates Inc.

Monitors: Gas

- General Atomics Electronic Systems, Inc.
- LND, Inc.
- Mirion Technologies

Monitors: Gas, Containment

- Apantec LLC
- General Atomics Electronic Systems, Inc.

Monitors: Gas, Hydrogen & Oxygen

ENMET Corporation

Monitors: Gas, Post-Accident

- General Atomics Electronic Systems, Inc.
- LND, Inc.
- Mirion Technologies

Monitors: Humidity

Elan Technical Corporation

Monitors: In-Core

- Mirion Technologies

RADIATION DETECTORS

LND, INC. HAS THE WORLD'S
LARGEST SELECTION OF
STANDARD RADIATION DETECTORS

- ✓ For Specific Data, Check Our Web Site
- ✓ Not On Our Website, Call or Fax
- ✓ Not A Standard, Utilize Our 35 Years Of Experience To Assist You In The Design And Manufacture Of A Detector To Your Specifications

- GM Counters
- BF Neutron Counters
- He³ Proportional Counters
- X-ray Proportional Counters
- Fission Chambers
- Neutron Beam Monitors
- Ionization Chambers
- Proton Recoil Counters
- Gas Sampling Detectors
- Position Sensitive Detectors
- Large Area α/β/γ Detectors



3230 Lawson Blvd. • Oceanside, NY 11572
TEL: 516-678-6111 • FAX: 516-678-6704
E-mail: info@lndinc.com • Web site: www.lndinc.com

New Products 2008



Ludlum Measurements, Inc.

Radiation Detection for a Safer World

www.ludlums.com

Monitors: Intermediate Range

- Data Systems & Solutions SAS
- Mirion Technologies
Thermo Scientific, Part of Thermo Fisher Scientific, Process Instruments Div.

Monitors: Iodine

- HI-Q Environmental Products Company
- Mirion Technologies

Monitors: Iodine Air

- Apantec LLC
- General Atomics Electronic Systems, Inc.
- HI-Q Environmental Products Company
- Mirion Technologies

Monitors: Laundry Radioactivity

- Ludlum Measurements, Inc.
- Mirion Technologies
- UniTech Services Group, Inc., Div. of Unifirst Corp.

Monitors: Liquid

- Apantec LLC
- General Atomics Electronic Systems, Inc.
- Mirion Technologies

Monitors: Local Power Range

- Mirion Technologies

Monitors: Noble Gas

- General Atomics Electronic Systems, Inc.
- Mirion Technologies

Monitors: Particulate

- General Atomics Electronic Systems, Inc.
- HI-Q Environmental Products Company
- Mirion Technologies

Monitors: Personal

Thermo Scientific

Monitors: Personnel Contamination

- Mirion Technologies
Thermo Scientific
- Thermo Scientific

Monitors: Portal

- Biodex Medical Systems
- Canberra Industries, Inc.

- Ludlum Measurements, Inc.
- Mirion Technologies
Thermo Scientific

Monitors: Portal Beta

- Ludlum Measurements, Inc.
- Mirion Technologies
Thermo Scientific

Monitors: Portal Gamma

- Mirion Technologies
Thermo Scientific

Monitors: Process Radiation

- General Atomics Electronic Systems, Inc.

Monitors: Radiation

- Berkeley Nucleonics Corp.
Biodex Medical Systems
- Canberra Industries, Inc.
- General Atomics Electronic Systems, Inc.
- HI-Q Environmental Products Company
- Ludlum Measurements, Inc.
- Mirion Technologies
S.E. International, Inc.
Thermo Scientific
WM B. Johnson & Associates Inc.

Monitors: Radioactive Waste Storage

- General Atomics Electronic Systems, Inc.
- HI-Q Environmental Products Company
- RMD Instrument Corp

Monitors: Shoe

- Ludlum Measurements, Inc.
WM B. Johnson & Associates Inc.

Monitors: Source Range

- Mirion Technologies
Thermo Scientific, Part of Thermo Fisher Scientific, Process Instruments Div.

Monitors: Stack Radiation

- General Atomics Electronic Systems, Inc.
- HI-Q Environmental Products Company

Monitors: Temperature

- Mirion Technologies
Wyle Laboratories, Inc.

Monitors: Tritium

- HI-Q Environmental Products Company
Overhoff Technology Corporation

Monitors: Vehicle

WM B. Johnson & Associates Inc.

Monitors: Waste

- Ludlum Measurements, Inc.
WM B. Johnson & Associates Inc.

Motor Control Center Refurbishment

- Nuclear Logistics, Inc.
Sciencetech
Wyle Laboratories, Inc.

Motor Control Centers: Safety-Related

- Nuclear Logistics, Inc.
Nutherm International, Inc.
Sciencetech
Spectrum Technologies, a Division of ATC
Trentec, Inc.
Wyle Laboratories, Inc.

Motor Control Centers: Safety-Related Parts

- Kinectrics Incorporated
- Nuclear Logistics, Inc.
Nutherm International, Inc.
Sciencetech
Trentec, Inc.
Wyle Laboratories, Inc.

Motor Operators: Repair

- Bartlett Holdings, Inc.
- Nuclear Logistics, Inc.
- Schulz Electric Company

Motor Refurbishing

- Nuclear Logistics, Inc.
- Schulz Electric Company

Motor Starters: Safety-Related

- Nuclear Logistics, Inc.
Nutherm International, Inc.
Sciencetech
Trentec, Inc.
Wyle Laboratories, Inc.

Motors: Auxiliary

- Nuclear Logistics, Inc.
- Schulz Electric Company

Motors: Contaminated, Repair

- Nuclear Logistics, Inc.
- Schulz Electric Company

Motors: Electric

- DIVESCO, Inc.
- Nuclear Logistics, Inc.
- Schulz Electric Company

Motors: Electric, Current Signature Analysis

- Schulz Electric Company

Motors: Electric, Repair

- Nuclear Logistics, Inc.
- Schulz Electric Company

Motors: Repair, Safety-Related

- Nutherm International, Inc.
- Schulz Electric Company

Motors: Safety-Related

- Nutherm International, Inc.
- Schulz Electric Company
Sciencetech
Wyle Laboratories, Inc.

Motors: Thermal Profiles

- Schulz Electric Company

MOV Motors: Safety-Related Testing

- Nuclear Logistics, Inc.
- Schulz Electric Company

NDE Equipment: Magnetic Particle

- Siemens Energy, Inc

NDE Services

- Babcock & Wilcox Canada
IHI Southwest Technologies, Inc.
International Quality Consultants, Inc.
Laboratory Services
Major Tool & Machine, Inc.
- Siemens Energy, Inc
Sonic Systems International, Inc.

EQUIPMENT RELIABILITY

Electric Motor/EDG Solutions for the Nuclear Industry

- Contaminated Motor Repair
- In-House Decon Facility
- MOV Motor Repair & Testing
- EQ (Inc. MOV) Insulation Systems
- New Safety-Related & EQ Motors
- Class 1E Motor Repair
- EDG Repair
- On-Site Services
- Vertical Test Stand



Above: Schulz Technicians using high pressure steam cleaning to decontaminate a 9000 hp rotor. Left: Completed rewind of 150 hp random wound motor pre-vpi.



30 Gando Drive
New Haven, CT 06513
(800) 826-1425
www.schulzelectric.com

- The Shaw Group Inc., Nuclear Power Division
- Westerman Nuclear
- NDE Services: Magnetic Particle**
- Schulz Electric Company
- Siemens Energy, Inc
- NDE Services: Radiographic Testing**
- Siemens Energy, Inc
- Westerman Nuclear
- NDE Services: Ultrasonic**
- Siemens Energy, Inc
- Sonic Systems International, Inc.
- NDE: Section XI Support**
- Laboratory Services
- Sonic Systems International, Inc.
- Neutron Absorption Materials**
- Bohler Bleche Sheet & Plate, Affil. of Bohler Blech GmbH, Murzzuschlag, Austria
- Ceradyne Boron Products, LLC
- Holtec International
- Nondestructive Testing & Evaluation**
- Babcock & Wilcox Canada
- Laboratory Services
- Schulz Electric Company
- Siemens Energy, Inc
- Tecnatom, S.A.
- Westerman Nuclear
- Nondestructive Testing Equipment**
- Technology for Energy Corporation (TEC)
- Tecnatom, S.A.
- Thermo Scientific, Niton Analyzers
- Nondestructive Testing Inspections**
- Quality Inspection Services, Inc
- R. Brooks Associates, Inc.
- Schulz Electric Company
- Tecnatom, S.A.
- Nondestructive Testing Services**
- Energy Resources Group, Inc.
- Hennigan Engineering Company, Inc.
- IHI Southwest Technologies, Inc.
- National Inspection & Consultants, Inc.
- Northeast Technology Corp.
- Siemens Energy, Inc
- Sonic Systems International, Inc.
- Technology for Energy Corporation (TEC)
- Tecnatom, S.A.
- Nondestructive Testing: Eddy Current**
- Siemens Energy, Inc
- Tecnatom, S.A.
- Nozzle Dam Installation**
- Scientech
- Nozzle Dams**
- Scientech
- Seal Master Corporation
- Nozzle Maintenance**
- Hydratight
- Siemens Energy, Inc
- NPT Stamp Holder**
- AT&F Nuclear, Inc, Division of American Tank and Fabricating
- Black & Veatch
- Precision Custom Components, LLC
- NSSS: Equipment Modification, BWR**
- Black & Veatch
- Nuclear Cask: Lead Hot Pours**
- Precision Custom Components, LLC
- Nuclear Fuel Cycle: Engineering**
- Black & Veatch
- CTR Technical Services, Inc.
- Nuclear: Shielding**
- CTR Technical Services, Inc.
- Nuts**
- Niagara Fasteners Inc.
- Trust Manufacturing
- Off-Gas Systems**
- AAF International
- Oil Analysis**
- Herguth Laboratories
- R&G Laboratories, Inc
- Oil Analysis Equipment**

- Herguth Laboratories
- Operating Services**
- UniStar Nuclear Energy
- WorleyParsons Group, Inc.
- Operation Procedure Upgrades**
- Enercon Services, Inc.
- EXCEL Services Corporation
- Scientech
- Operations Support**
- AMEC NSS Limited, AMEC NCL
- Black & Veatch
- Burns and Roe
- EXCEL Services Corporation
- G.D. Barri & Associates, Inc.
- Serdula Systems Ltd.
- The Shaw Group Inc., Nuclear Power Division
- Outage Equipment**
- Argo Turboserve Corporation (ATC)
- E.H. Wachs Co.
- Hydratight
- Mirion Technologies
- Outage Management**
- EXCEL Services Corporation
- Sargent & Lundy
- The Shaw Group Inc., Nuclear Power Division
- Outage Modification Implementation**
- The Shaw Group Inc., Nuclear Power Division
- Outage Planning**
- EXCEL Services Corporation
- Sargent & Lundy
- Siemens Energy, Inc
- Sonic Systems International, Inc.
- The Shaw Group Inc., Nuclear Power Division
- Outage Planning: BWR**
- EXCEL Services Corporation
- Siemens Energy, Inc
- Outage Support Services**
- AMEC NSS Limited, AMEC NCL
- Bartlett Holdings, Inc.

- Day & Zimmermann Power Services
- Enertech
- EXCEL Services Corporation
- RCM Technologies, Inc.
- Sargent & Lundy
- Schulz Electric Company
- Scientech
- Sonic Systems International, Inc.
- Studsvik, Inc
- The Shaw Group Inc., Nuclear Power Division
- UniTech Services Group, Inc., Div. of Unifirst Corp.
- Outage Support: Radiation Protection**
- Siemens Energy, Inc
- Painting**
- The Shaw Group Inc., Nuclear Power Division
- Panels: Custom, Safety-Related**
- Nutherm International, Inc.
- Scientech
- SSM Industries, Inc.
- Wyle Laboratories, Inc.
- Panels: Instrument**
- Nuclear Logistics, Inc.
- Scientech
- Temp-Pro Inc.
- Wyle Laboratories, Inc.
- Panels: Power Distribution, Safety-Related**
- Kinectrics Incorporated
- Nuclear Logistics, Inc.
- Nutherm International, Inc.
- Scientech
- Wyle Laboratories, Inc.
- Panels: Safety-Related**
- Kinectrics Incorporated
- Nuclear Logistics, Inc.
- Nutherm International, Inc.
- Scientech
- Trentec, Inc.
- Wyle Laboratories, Inc.

Neutron Absorber Materials



- BORAL® Composite
- BORTEC® MMC
- Borated Aluminum
- Enriched Boron
- Natural Boron Carbide

ceradyne, inc.

418-693-0227
nuclear@ceradyne.com
www.ceradyne.com

Parts Evaluation

- Kinectrics Incorporated
- Nuclear Logistics, Inc. Scientech
- Siemens Energy, Inc Trentec, Inc.
- Wyle Laboratories, Inc.

Parts: BWR Spare

- DIVESCO, Inc.
- Nuclear Logistics, Inc. Scientech
- Wyle Laboratories, Inc.

Parts: O.E.M.

- Enertech
- GE Hitachi Nuclear Energy
- Nuclear Logistics, Inc. Scientech
- Siemens Energy, Inc Spectrum Technologies, a Division of ATC Trentec, Inc.
- Trust Manufacturing Wyle Laboratories, Inc.

Parts: Procurement Assistance

- Argo Turboserve Corporation (ATC)
- DIVESCO, Inc.
- Energy & Process Corporation
- Kinectrics Incorporated
- Nuclear Logistics, Inc. Scientech Trentec, Inc.
- Trust Manufacturing Wyle Laboratories, Inc.

Parts: Replacement

- DIVESCO, Inc. Enertech
- Schulz Electric Company Scientech
- Siemens Energy, Inc Trentec, Inc.
- Trust Manufacturing Wyle Laboratories, Inc.

Parts: Replacement, Design

- Atomic Energy of Canada Limited
- Nuclear Logistics, Inc. Scientech
- Siemens Energy, Inc Trentec, Inc.
- Trust Manufacturing Wyle Laboratories, Inc.

Parts: Spare

- Argo Turboserve Corporation (ATC)
- DIVESCO, Inc. Enertech
- Joseph Oat Corporation
- Nuclear Logistics, Inc. Scientech
- Siemens Energy, Inc Spectrum Technologies, a Division of ATC Trentec, Inc.
- Trust Manufacturing Wyle Laboratories, Inc.

Parts: Used

Scientech

Penetrations: Containment

- Black & Veatch
- Mirion Technologies Scientech

Penetrations: Electrical

- Black & Veatch
- Mirion Technologies Scientech
- Wyle Laboratories, Inc.

Penetrations: Electrical, Adaptor Modules

- Mirion Technologies Scientech

Performance Monitoring Equipment

- Siemens Energy, Inc

Personal Computers: Air Quality Sampling

- HI-Q Environmental Products Company

Personnel Services

Bartlett Holdings, Inc.

Pigs: Pipeline

Scientech
T. D. Williamson, Inc.

Pipe

- ATI Wah Chang
- Black & Veatch Energy & Process Corporation
- The Shaw Group Inc., Nuclear Power Division Tioga Pipe Supply Company Inc.
- Trust Manufacturing

Pipe Assemblies

AT&F Nuclear, Inc, Division of American Tank and Fabricating
Energy & Process Corporation
Joseph Oat Corporation

Pipe Benders

- The Shaw Group Inc., Nuclear Power Division

Pipe Bending

IMI Components Ltd.
The Shaw Group Inc., Nuclear Power Division

Pipe Bends

- The Shaw Group Inc., Nuclear Power Division
- Trust Manufacturing

Pipe Beveling Machinery

E.H. Wachs Co.
Hydratight
Tri Tool Inc.

Pipe Beveling Tools: Rental

E.H. Wachs Co.
Hydratight

Pipe Beveling: Field Service

Hydratight
Tri Tool Inc.

Pipe Cleaning Chemicals

Hennigan Engineering Company, Inc.

Pipe Cleaning Service

Fuel Tank Maintenance Company LLC
Hennigan Engineering Company, Inc.

The Well-Rounded Solution for All Your Supply Needs.

DIVESCO
Delivering NuClear Solutions

601.932.1934 www.DIVESCO.com

Pipe Crawlers

R. Brooks Associates, Inc.

Pipe Cutting Machinery

E.H. Wachs Co.
Hydratight

Pipe Cutting Tools: Rental

E.H. Wachs Co.
Hydratight

Pipe Cutting: Field Service

Hydratight
• Siemens Energy, Inc
• Tri Tool Inc.

Pipe End Finishing Machine

E.H. Wachs Co.
Hydratight

Pipe Fabrication

ATI Wah Chang
Hydratight
IMI Components Ltd.
Penn Iron Works, Inc.
• Siemens Energy, Inc
• The Shaw Group Inc., Nuclear Power Division
• Trust Manufacturing

Pipe Fabrication: Class 1

• Joseph Oat Corporation
• Trust Manufacturing

Pipe Fabrication: Class 2

• Joseph Oat Corporation
• Trust Manufacturing

Pipe Fabrication: Class 3

• Joseph Oat Corporation
• Trust Manufacturing

Pipe Fittings

Energy & Process Corporation
Energy & Process Corporation
• Siemens Energy, Inc
• The Shaw Group Inc., Nuclear Power Division
Tioga Pipe Supply Company Inc.
• Trust Manufacturing

Pipe Fittings: Cast Iron

• Trust Manufacturing

Pipe Fittings: Ductile Iron

• Trust Manufacturing

Pipe Fittings: Flanged-Weldneck-Slip On

• Trust Manufacturing

Pipe Fittings: High-Alloy Steel

Tioga Pipe Supply Company Inc.
• Trust Manufacturing

Pipe Fittings: Low-Alloy Steel

• Trust Manufacturing

Pipe Fittings: Miscellaneous Metal

• Trust Manufacturing

Pipe Fittings: Tee's

Tioga Pipe Supply Company Inc.
• Trust Manufacturing

Pipe Freezing

T. D. Williamson, Inc.

Pipe Hangers

• The Shaw Group Inc., Nuclear Power Division

Pipe Heating Products

Hydratight
TRANTER

Pipe Snubbers

Wyle Laboratories, Inc.

Pipe Supports

• The Shaw Group Inc., Nuclear Power Division

Pipe: Alloy

Rockwell Collins Rollmet
• The Shaw Group Inc., Nuclear Power Division
Tioga Pipe Supply Company Inc.
• Trust Manufacturing

Pipe: Aluminum

Rockwell Collins Rollmet
• The Shaw Group Inc., Nuclear Power Division
• Trust Manufacturing

Pipe: Carbon-Steel

• The Shaw Group Inc., Nuclear Power Division
Tioga Pipe Supply Company Inc.
• Trust Manufacturing

Pipe: Chemical Decontamination

• UniTech Services Group, Inc., Div. of Unifirst Corp.

Pipe: Copper

• Trust Manufacturing

Pipe: Copper Alloy

• Trust Manufacturing

Pipe: Corrosion-Resistant

Tioga Pipe Supply Company Inc.
• Trust Manufacturing

Pipe: High-Alloy Steel

Energy & Process Corporation
Penn Iron Works, Inc.
Rockwell Collins Rollmet
Tioga Pipe Supply Company Inc.
• Trust Manufacturing

Pipe: Low-Alloy

Penn Iron Works, Inc.
Rockwell Collins Rollmet

Pipe: Stainless Steel

Energy & Process Corporation
Penn Iron Works, Inc.
Rockwell Collins Rollmet
• The Shaw Group Inc., Nuclear Power Division
Tioga Pipe Supply Company Inc.
• Trust Manufacturing

Pipe: Titanium

ATI Wah Chang

Pipe: Zirconium

ATI Wah Chang

Piping Analysis

Design Engineering Analysis Corporation
EXPONENT
• Proto-Power Corporation
Sargent & Lundy
• The Shaw Group Inc., Nuclear Power Division

The only thing more dependable than a TRI TOOL® portable machine tool is our

ON-SITE SERVICE



- NUCLEAR MAINTENANCE
- PIPELINE & OFFSHORE
- DECOMMISSIONING
- FOSSIL & BOILER MAINT.
- IN-PLACE MACHINING
- FLANGE FACING/MILLING

Tri Tool Inc. Construction and Maintenance Field Services provide the energy industry with a wide range of precision equipment and service solutions. Whether for economical equipment rental options or for emergency outage support, Tri Tool stands ready to respond to your most demanding on-site service requirements. Call today for more information.

A National Network of Offices to serve you!

(800) 356-3343 or (404) 763-8704

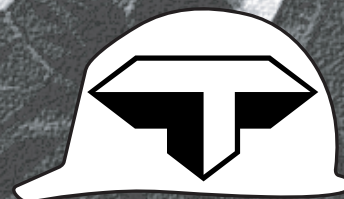

TRI TOOL INC.
www.tritool.com

Field Machining • Code Welding • Fabrication • Special Engineering Services

Piping Design

- Proto-Power Corporation
Sargent & Lundy
- The Shaw Group Inc., Nuclear Power Division
Wyle Laboratories, Inc.

Piping Inspection

- Hennigan Engineering Company, Inc.
Interrest, Inc.
R. Brooks Associates, Inc.

Piping Maintenance

Hydratight

Piping Repair

- Black & Veatch
Hydratight
- Siemens Energy, Inc.
T. D. Williamson, Inc.
- Underwater Construction Corporation
Welding Services Inc.

Piping Replacement

- Black & Veatch
Hydratight
T. D. Williamson, Inc.
Welding Services Inc.

Planchets

- Biodex Medical Systems
Coastal Network, Inc.
Staplex-Air Sampler Division

Planning Services

MOTA Corporation

Plant Upgrading/Uprating

- ANSALDO NUCLEARE SPA
- Day & Zimmermann Power Services
- EXCEL Services Corporation
Sargent & Lundy
- Siemens Energy, Inc.
- The Shaw Group Inc., Nuclear Power Division

Plugs

- Joseph Oat Corporation
Scientech
- Seal Master Corporation

Plugs: Condenser

- Joseph Oat Corporation

Plugs: Feedwater Heater

- Joseph Oat Corporation
Powerfect

Plugs: Freeze

T. D. Williamson, Inc.

Plugs: Recirculation Pipe

Scientech

Plugs: Stud Hole

Scientech

- Seal Master Corporation

Plugs: Thimble

Scientech

Poison: Burnable

- Ceradyne Boron Products, LLC

Pollution Control Systems

- NUCON International, Inc.

Polyethylene: Fire-Retardant

Apco Extruders Inc.

Polymer Solidification Services

Diversified Technologies Services, Inc.

Post Irradiation Examination

- GE Hitachi Nuclear Energy

Power Conditioners

AMETEK Programmable Power, Supporting Elgar Nuclear Equip.

- Nuclear Logistics, Inc.

Power Plants

- ANSALDO NUCLEARE SPA
- Black & Veatch

Power Supplies

AMETEK Programmable Power, Supporting Elgar Nuclear Equip.

- Wyle Laboratories, Inc.

Power Supplies: High-Voltage

- Data Systems & Solutions SAS
- Nuclear Logistics, Inc.

Power Supplies: Safety-Related

- Data Systems & Solutions SAS
- Nuclear Logistics, Inc.
Nutherm International, Inc.
Scientech
Thermo Scientific, Part of Thermo Fisher Scientific, Process Instruments Div.
Trentec, Inc.
Wyle Laboratories, Inc.

Power Systems: Photovoltaic

- Data Systems & Solutions SAS
Minuteman International, Inc.

Preamplifiers: Instrumentation

- Data Systems & Solutions SAS
- Mirion Technologies

Predictive Maintenance Systems: Electrical

- Data Systems & Solutions SAS
Wyle Laboratories, Inc.

Preheating Services

Hydratight

Pressure Regulators

- Air Liquide America Specialty Gases, LLC
Enertech
- Nuclear Logistics, Inc.

Pressure Vessel Analysis

- Babcock & Wilcox Canada
- Black & Veatch
EXPONENT
- Joseph Oat Corporation

Pressure Vessels

- AT&F Nuclear, Inc, Division of American Tank and Fabricating
- Babcock & Wilcox Canada
- Black & Veatch
- Joseph Oat Corporation
Major Tool & Machine, Inc.
Penn Iron Works, Inc.
Precision Custom Components, LLC
- Westerman Nuclear

Pressurizer Heater Maintenance

Hydratight

Pressurizers

- Babcock & Wilcox Canada
Precision Custom Components, LLC

Primary-Side Piping

Precision Custom Components, LLC

Probabilistic Risk Assessment

- ABS Consulting
- EXCEL Services Corporation
EXPONENT
Relcon Scandpower AB
Sargent & Lundy
Scientech
Serdula Systems Ltd.
- Probabilistic Risk Assessment: BWR**
- EXCEL Services Corporation
Scientech
- Probabilistic Safety Analysis**
- ABS Consulting
- EXCEL Services Corporation
EXPONENT
Sargent & Lundy
Scientech
VTT Technical Research Centre of Finland

Probes: Gamma

- LND, Inc.
- Ludlum Measurements, Inc.
- Mirion Technologies
WM B. Johnson & Associates Inc.

Probes: Geiger-Mueller

- LND, Inc.
- Ludlum Measurements, Inc.
- Mirion Technologies
WM B. Johnson & Associates Inc.

Probes: Geiger-Mueller, End Window

- Biodex Medical Systems
- LND, Inc.
- Ludlum Measurements, Inc.

Probes: Geiger-Mueller, Pancake

- Biodex Medical Systems
- LND, Inc.
- Ludlum Measurements, Inc.
WM B. Johnson & Associates Inc.

Probes: Geiger-Mueller, Side Window

- LND, Inc.
- Ludlum Measurements, Inc.
WM B. Johnson & Associates Inc.

Probes: Traversing In-Core Gamma

- Mirion Technologies

Probes: Traversing In-Core Neutron

- Mirion Technologies

Probes: Ultrasonic

Interrest, Inc

Procedure Development

- Enercon Services, Inc.
- EXCEL Services Corporation
Sargent & Lundy
Scientech
The Delphi Groupe, Inc.
Wyle Laboratories, Inc.

Procedure Development: Plant System

- EXCEL Services Corporation
- Siemens Energy, Inc

Procedure Development: Root Cause

- Conger & Elsea, Inc.
- EXCEL Services Corporation
EXPONENT
Wyle Laboratories, Inc.

Procedure Development: Site Specific

- EXCEL Services Corporation
WMG, Inc.

Process Control Systems

- Air Monitor Corp.
- Data Systems & Solutions SAS
- Mirion Technologies
Sargent & Lundy

Process Instrumentation Maintenance

- Data Systems & Solutions SAS

Process Protection Systems

- Data Systems & Solutions SAS

Directory 2010
Reserve
advertising space
in the Product &
Service Directory
2010. The ad
space reservation
deadline for
reserving is
November 18,
2009.

Contact:
Nuclear Plant Journal
Phone: (630) 858-6161, ext. 103
Fax: (630) 858-8787
E-mail: NPJ@goinfo.com

110 1011 011.



AnsaldoNucleare

A Finmeccanica Company

Always ahead in the advance of civilisation



Our strengths: experience,
capability and reliability founded on the quality
of our skills and human resources.
This is how we design and build the future.

www.ansaldonucleare.it

FINMECCANICA

Your Trusted Partner For Generations

Since the birth of nuclear power Flowserve has been the leading supplier of pumps for the nuclear industry, including the most critical applications. Today Flowserve nuclear pumps and seals are delivering safe and reliable performance in more than 200 plants worldwide. With a sophisticated, evolving array of aftermarket and engineering solutions, Flowserve will continue to be the leader that customers trust for generations to come.

Flowserve Pumps for the Nuclear Industry

ASME Code Class 1, 2 and 3 Pumps and Mechanical Seals, including:

- Primary Coolant / Primary Heat Transport/ Reactor Recirculation
- Residual Heat Removal
- Containment / Core Spray
- Safety Injection
- Emergency Core Cooling
- Charging / Makeup
- Shutdown Cooling
- Essential Service Water
- Screen Wash
- Emergency Feedwater
- D2O Supply
- Main Moderator
- Reactor Water Cleanup
- Component Cooling Water

Balance Of Plant (BOP) Pumps and Mechanical Seals, including:

- Reactor Feed / Steam Generator Feed
- Circulating Water
- Condensate Extraction
- Heater Drain
- Feedwater / Condensate Booster
- Other Services



Experience In Motion



Product Brands of Distinction

Byron Jackson®

Worthington®

Pacific®

Flowserve Aftermarket Services

Parts

- OEM standards
- Material certification
- Material upgrades for improved MTBR
- Worldwide supply

Full Repair and Field Service Capabilities

- Return to OEM standards
- Material and engineering upgrades
- Performance testing including contaminated pumps
- Field supervision
- Turnkey removal and installation including detailed project planning
- Special tooling to reduce outage duration and exposure
- Contaminated repair capabilities

Engineering Services

- Engineering support for hydraulic, mechanical and material upgrades
- State-of-the-art training facilities
- Up-rate design reviews

For more information, contact your local Flowserve representative or visit <http://nuclear.flowserve.com>

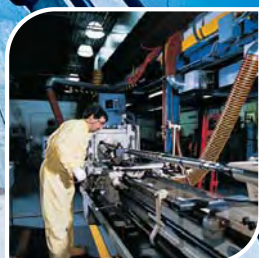

flowserve.com

Procurement

- Burns and Roe
- Kinectrics Incorporated
- Scientech
- The Shaw Group Inc., Nuclear Power Division
- The Shaw Group Inc., Nuclear Power Division
- Trentec, Inc.

Procurement Management

- Black & Veatch
- Scientech
- Siemens Energy, Inc

Professional Conferences

- WM Symposia,

Project Management

- Bechtel Power
- Black & Veatch
- CS-2 Inc.
- EXCEL Services Corporation
- GE Hitachi Nuclear Energy
- Kinectrics Incorporated
- MOTA Corporation
- Sargent & Lundy
- Siemens Energy, Inc
- Studsvik, Inc
- The Delphi Groupe, Inc.
- WMG, Inc.

Project Management: Underwater

- WMG, Inc.

Protective Clothing Lease

- UniTech Services Group, Inc., Div. of Unifirst Corp.

Public Relations

- Supersaturated Environments, (Div. of Reflection Imaging, Inc.)

Publications

- OECD Nuclear Energy Agency (NEA)

Pump Analysis

- Black & Veatch
- Flowserve Pump Division

Pump Overhauling

- Enertech
- Flowserve Pump Division

Pump Parts

- BW/IP International, Inc.
- Enertech
- Nuclear Logistics, Inc.

Pump Service

- Enertech
- Flowserve Pump Division

Pump: Chemical Decontamination

- UniTech Services Group, Inc., Div. of Unifirst Corp.

Pumps

- Atomic Energy of Canada Limited
- DIVESCO, Inc.
- Enertech
- Flowserve Pump Division
- Nuclear Logistics, Inc.

Pumps: Air Sampling

- HI-Q Environmental Products Company
- Nuclear Logistics, Inc.

Pumps: Auxiliary

- Flowserve Pump Division
- Nuclear Logistics, Inc.

Pumps: Canned Motor

- Enertech
- Nuclear Logistics, Inc.

Pumps: Centrifugal

- BW/IP International, Inc.
- Enertech
- Flowserve Pump Division
- HI-Q Environmental Products Company
- Nuclear Logistics, Inc.

Pumps: Circulating

- BW/IP International, Inc.
- Flowserve Pump Division
- Nuclear Logistics, Inc.

Pumps: Cooling

- Flowserve Pump Division

- Nuclear Logistics, Inc.

Pumps: Mag Drive

- Enertech
- Flowserve Pump Division

Pumps: Rebuilding

- Flowserve Pump Division

Pumps: Repair

- BW/IP International, Inc.
- Enertech
- Flowserve Pump Division

Pumps: Rotary Vane

- HI-Q Environmental Products Company

Pumps: Safety-Related

- BW/IP International, Inc.
- Enertech
- Nuclear Logistics, Inc.

Pumps: Sampling

- HI-Q Environmental Products Company

Pumps: Sealless

- Flowserve Pump Division

Pumps: Vacuum

- HI-Q Environmental Products Company

Qualification: Supplier

- Kinectrics Incorporated
- Nutherm International, Inc.
- Scientech
- Sonic Systems International, Inc.
- Southern Testing Services, a Division of ATC
- Spectrum Technologies, a Division of ATC
- Trentec, Inc.
- Wyle Laboratories, Inc.

Quality Assurance

- Bechtel Power
- Black & Veatch
- EXCEL Services Corporation
- NPTS, Inc.
- Scientech
- Sonic Systems International, Inc.
- The Shaw Group Inc., Nuclear Power Division

Quality Assurance Equipment

- Thermo Scientific, Niton Analyzers

Quality Assurance Programs

- EXCEL Services Corporation

Quality Assurance Services

- EXCEL Services Corporation
- International Quality Consultants, Inc.
- National Inspection & Consultants, Inc.
- Sargent & Lundy
- Scientech
- Sonic Systems International, Inc.
- The Shaw Group Inc., Nuclear Power Division

Quality Control Services

- International Quality Consultants, Inc.
- National Inspection & Consultants, Inc.
- Quality Inspection Services, Inc
- Sargent & Lundy
- Scientech
- Sonic Systems International, Inc.

Quality Improvement Programs

- EXCEL Services Corporation
- Sargent & Lundy

Quality Management

- EXCEL Services Corporation

R&D Nondestructive Services

- Atomic Energy of Canada Limited
- R. Brooks Associates, Inc.

R&D Services

- Atomic Energy of Canada Limited
- CTR Technical Services, Inc.
- Herguth Laboratories
- Kinectrics Incorporated
- R. Brooks Associates, Inc.
- STN Service Center Europe
- Wyle Laboratories, Inc.

R&D: Chemistry

- Herguth Laboratories

R&D: Fluid Mechanics

- Wyle Laboratories, Inc.

WM Symposia, Inc.
A non-profit dedicated to education and opportunity is pleased to announce

Join Us at

WM2009



in the
Phoenix
Convention
Center

PLAN NOW
TO ATTEND
OUR 35TH
MEETING!

www.wmsym.org

WASTE MANAGEMENT
FOR THE NUCLEAR
RENAISSANCE

- March 1-5, 2009
- For more information, contact WMS at +1 520-696-0399
- Registration & Hotel information at www.wmsym.org
- Exhibitors/Sponsors contact Mary Young at +1 480 968 7559 or mary@wmarizona.org

Hosted and sponsored by the University of Arizona, the American Nuclear Society, the American Society of Mechanical Engineers, the Institute of Nuclear Engineers, New Mexico State University, the Academy of Certified Hazardous Materials Managers, the Waste Management Education and Research Consortium (WERC), and the Organization for Economic Co-operation and Development / the Nuclear Energy Agency. www.wmsym.org

Editorial Schedule

January-February	International Trade & Waste and Fuel Management
March-April	Plant Maintenance & Plant Life Extension
May-June.....	Outage Management & Health Physics
July-August.....	New Plants and Vendor Advertorials
September-October	Plant Maintenance & Advanced Reactors
November-December	Annual Product & Service Directory

News Releases

Nuclear Plant Journal may include complimentary announcements in the following departments:

- Utility, Industry and Corporation News
- New Documents
- New Products, Services and Contracts
- Systems, Software and Videotapes

The news release should include a description of the application of the product or the service to the nuclear power industry. The submittal may include a 60-80 word proposed paragraph, which may be considered for verbatim inclusion in the Journal.

Photographs may also be submitted with the release. News releases will be selected based on the quality of their content; however, advertisers will be given preference over non-advertisers. Non-advertisers may pay a \$150.00 fee to have their news release included in an issue in which they are not advertising.

Sales leads are sent cost-free to designated editorial contacts for news releases. Duplicate copies of sales leads will be provided, if needed, for a \$75.00 fee. Reader service numbers are not provided for announcements in the Utility and Industry News departments.

Meeting & Training Calendar

There is a \$150.00 fee for an organization to announce up to three events in the Meeting & Training Calendar in one issue of *Nuclear Plant Journal*. The announcement will include basic information about who, what, when and where and the name, phone and fax numbers of the contact person.

Technical Papers

Refer to the Call for Papers and Submittal Guidelines.

Cover Pictures

The cover of *Nuclear Plant Journal* will be selected from color pictures of nuclear power plants, inside or outside views. The quality, professional significance and caption message will be of prime consideration in the selection of a picture. Interior shots are preferred over exterior shots.

Guidelines

- **An electronic file of the cover picture may be submitted on a CD-ROM.** The cover picture should be a high-resolution electronic file. A four-color print must also accompany the electronic file.
- The picture may be submitted as a **vertical** 8 x 10-inch glossy color print.
- All submittals must include a 50-word caption highlighting current information on the featured plant.
- The submittal should include a release letter (on company letterhead) authorizing EQES, Inc. to use the picture for the cover, subsequent reprints or any other EQES, Inc. literature, including display at exhibitions.

Interviews

Interviews with chief executive officers, presidents or other senior executives may be conducted by the editor for use in *Nuclear Plant Journal*. The interviewed party must provide travel, boarding and lodging arrangements and, if needed, an interpreter and a photographer.

Open Houses & Demonstrations

Nuclear Plant Journal staff may attend open houses, demonstrations or other events organized by utilities, manufacturers and other organizations. The host organization must provide travel, boarding and lodging arrangements and, if needed, an interpreter and a photographer.

Nuclear Plant Journal, a 26-year publication, provides technical information exchange among managers and engineers in the nuclear power industry. Open houses and demonstrations are only for the background information of the editor. A concurrent interview with the chief executive may be held during a visit to develop an article.

Nuclear Plant Journal

799 Roosevelt Road
Building 6, Suite 208
Glen Ellyn, IL 60137-5925 USA
Telephone: (630) 858-6161, X103
Fax: (630) 858-8787
E-mail: NPJ@goinfo.com
<http://www.NPJOnline.com>



R&D: Fuel

- Atomic Energy of Canada Limited
- OECD Nuclear Energy Agency (NEA)

R&D: Heat Transfer

- Atomic Energy of Canada Limited

R&D: Information Systems

STN Service Center Europe

R&D: Instrumentation/Control Systems

- CTR Technical Services, Inc.
- Data Systems & Solutions SAS
- Scientech

R&D: Materials Performance

- Atomic Energy of Canada Limited
- Babcock & Wilcox Canada
- Kinectrics Incorporated
- VTT Technical Research Centre of Finland

R&D: Metallurgy

- ATI Wah Chang
- Babcock & Wilcox Canada

R&D: Nondestructive Testing

- Atomic Energy of Canada Limited
- R. Brooks Associates, Inc.

R&D: Radwaste Disposal

OECD Nuclear Energy Agency (NEA)
VTT Technical Research Centre of Finland

R&D: Radwaste Treatment

- Kinectrics Incorporated

R&D: Reactor

CTR Technical Services, Inc.

R&D: Reactor Safety

CTR Technical Services, Inc.
OECD Nuclear Energy Agency (NEA)

R&D: Reactors

CTR Technical Services, Inc.

R&D: Regulatory

- EXCEL Services Corporation
- OECD Nuclear Energy Agency (NEA)

R&D: Robotics

- Atomic Energy of Canada Limited

R&D: Structural Mechanics

- Atomic Energy of Canada Limited

Racks: Storage

- Holtec International
- Joseph Oat Corporation
- Modern Equipment Company, Inc.
- SKODA JS a.s.

Radiation Assessment

Sargent & Lundy
WMG, Inc.

Radiation Detection/Monitoring Systems

- Berkeley Nucleonics Corp.
- Canberra Industries, Inc.
- General Atomics Electronic Systems, Inc.
- HI-Q Environmental Products Company
- LND, Inc.
- Ludlum Measurements, Inc.
- Mirion Technologies
- TechniDATA AG
- Thermo Scientific

Radiation Shielding Systems

- Ceradyne Boron Products, LLC
- LANCS Industries, Inc.

Radiation Vehicle Monitoring Systems

- General Atomics Electronic Systems, Inc.
- Mirion Technologies
- Thermo Scientific
- WM B. Johnson & Associates Inc.

Radioactive Solid Waste Tank Remediation

- Ceradyne Boron Products, LLC

Radiochemistry

Eberline Services Inc.

Radiography: Neutron

- GE Hitachi Nuclear Energy

Radiological Protection Services

Bartlett Holdings, Inc.
Eberline Services Inc.

Radiological Surveys

- Eberline Services Inc.
- Millennium Services, Inc.
- Mirion Technologies

Radon Detection Services

Radiation Safety Institute of Canada
RTCA-Radon Testing Corp. of America

Radwaste

- Black & Veatch
- Ceradyne Boron Products, LLC
- Kinectrics Incorporated
- LANCS Industries, Inc.
- Studsvik, Inc

Radwaste Analysis

- Canberra Industries, Inc.
- Kinectrics Incorporated
- S.M. Stoller Corp.
- Sargent & Lundy
- WMG, Inc.

Radwaste Compaction Equipment

Container Products Corporation
S&G Enterprises, Inc.
Waste Control Systems, Inc.

Radwaste Compaction: Supercompact

Container Products Corporation

Radwaste Disposal Services

- NSSI/Recovery Services Inc.
- Studsvik, Inc

Radwaste Equipment

- Morris Material Handling (P&H)
- Westerman Nuclear

Radwaste Equipment: Low-Level

- Container Products Corporation
- S&G Enterprises, Inc.
- Westerman Nuclear

Radwaste Handling

- AREVA Inc., AREVA NC Inc.
- Morris Material Handling (P&H)
- PTP Spent Fuel Services, LLC.
- Serapid

Since 1986



**Westerman
Companies**

NQA-1 and ISO 9001/2000

**ASME SECTION III
Nuclear Subassembly
Reactor Components
Material Certifications**

**ASME SECTION VIII
Rad Waste Containers
Pressure Vessels
Heat Exchangers**

800-338-8265

www.westermancompanies.com



Studsvik

Full-Service Waste Processing

Studsvik is the industry's most accomplished and capable processor of all types of low-level radioactive wastes. Studsvik's services include:

- Volume reduction and disposal of Class A/B/C resins, filters, and filter media wastes
- BSFR disposal of remediation and decommissioning wastes
- Volume reduction and disposal of large components
- Logistics

For more information on our capabilities, see our listing in this directory. If you are interested in more information, please do not hesitate to contact us.



Radwaste Management Services
Diversified Technologies Services, Inc.

- Studsvik, Inc
WMG, Inc.

Radwaste Packaging

Container Products Corporation
Reef Industries, Inc.
WMG, Inc.

Radwaste Polybags

LANCS Industries, Inc.
Reef Industries, Inc.

- UniTech Services Group, Inc., Div. of Unifirst Corp.

Radwaste Processing

Diversified Technologies Services, Inc.

- Studsvik, Inc
Suncoast Solutions, Inc.

Radwaste Reduction System Design

- Studsvik, Inc

Radwaste Supplies

- Mohawk Industrial & Nuclear Supply, Inc.
• UniTech Services Group, Inc., Div. of Unifirst Corp.

Radwaste Tanks

- Westerman Nuclear

Radwaste Transportation

- Studsvik, Inc

Radwaste Treatment Services

NSSI/Recovery Services Inc.

- Studsvik, Inc

Radwaste Volume Reduction

Container Products Corporation
Diversified Technologies Services, Inc.
Fortum Nuclear Services Ltd.
S&G Enterprises, Inc.

- Studsvik, Inc
• Underwater Construction Corporation
• UniTech Services Group, Inc., Div. of Unifirst Corp.

Ratemeters

- Ludlum Measurements, Inc.

Ratemeters: Alarming

Biodex Medical Systems
Data Systems & Solutions SAS
Ludlum Measurements, Inc.

Reactor Control Systems

- Black & Veatch
• Data Systems & Solutions SAS
• The Shaw Group Inc., Nuclear Power Division

Reactor Core Components

GE Hitachi Nuclear Energy
Precision Custom Components, LLC

Reactor Core Design

CTR Technical Services, Inc.

Reactor Core Structure

Precision Custom Components, LLC

Reactor Design Services

- The Shaw Group Inc., Nuclear Power Division

Reactor Head Removal Services

- Bechtel Power
• Bigge Power Constructors
Rigging International
WMG, Inc.

Reactor Head Repair

Precision Custom Components, LLC

Reactor Head Tensioning Equipment

- Biach Industries, Inc.
SKODA JS a.s.
• Trust Manufacturing

Reactor Internals

- AT&F Nuclear, Inc, Division of American Tank and Fabricating
Precision Custom Components, LLC
SKODA JS a.s.

Reactor Internals Modification

- GE Hitachi Nuclear Energy

Reactor Protection Systems

- Data Systems & Solutions SAS
Scientech
Thermo Scientific, Part of Thermo Fisher Scientific,
Process Instruments Div.

Reactor Repair

- Black & Veatch

Reactor Repair: Underwater, BWR

- Underwater Construction Corporation

Reactor Services

- Atomic Energy of Canada Limited
• GE Hitachi Nuclear Energy
Scientech

Reactor Vessel Components

AT&F Nuclear, Inc, Division of American Tank and Fabricating
Precision Custom Components, LLC

- Trust Manufacturing

Reactor Vessel Repair

- Black & Veatch

Reactors

- UniStar Nuclear Energy

Reactors: Advanced Passive PWR

- Black & Veatch
• The Shaw Group Inc., Nuclear Power Division

Reactors: Advanced PWR

- Black & Veatch
• UniStar Nuclear Energy

Reactors: Advanced Systems, BWR

- Black & Veatch
• GE Hitachi Nuclear Energy
• The Shaw Group Inc., Nuclear Power Division

Reactors: BWR: Equipment Upgrades

- GE Hitachi Nuclear Energy

Reactors: Engineering

- Atomic Energy of Canada Limited
• Black & Veatch
CTR Technical Services, Inc.
• The Shaw Group Inc., Nuclear Power Division

Reactors: Heavy Water

- Atomic Energy of Canada Limited

Reactors: PWR

- Black & Veatch
• The Shaw Group Inc., Nuclear Power Division
• The Shaw Group Inc., Nuclear Power Division
• UniStar Nuclear Energy

Recorders: Panel Mounted

Engine Systems, Inc.
SOLTEC Corporation

Records Management

S.M. Stoller Corp.
Sargent & Lundy
Scientech

Records Management Systems

- Black & Veatch
• EXCEL Services Corporation

Recovery: Asset

- DIVESCO, Inc.
Scientech

Rectifiers

- Nuclear Logistics, Inc.

Refacing Equipment: Flanges

- E.H. Wachs Co.
Hydratight
• Tri Tool Inc.

Refrigerators: Lead-Lined

Biodex Medical Systems

Refueling Equipment

Morris Material Handling (P&H)
Scientech

Refueling Equipment: Refurbishing

Morris Material Handling (P&H)
Scientech

Registers

- Nuclear Logistics, Inc.

Regulatory Compliance

- Black & Veatch
EXPONENT
Scientech

Regulatory Compliance: 10CFR50.59

- Bechtel Power
• Black & Veatch

- EXCEL Services Corporation
Scientech

Regulatory Compliance: 10CFR50.65

- EXCEL Services Corporation
Scientech

Relay Systems

- Data Systems & Solutions SAS

Relays: Safety-Related

- Data Systems & Solutions SAS
• Nuclear Logistics, Inc.
Nutherm International, Inc.
Scientech
Trentec, Inc.
Wyle Laboratories, Inc.

Reliability Database Services

- Data Systems & Solutions SAS
• EXCEL Services Corporation

Remediation

- MOTA Corporation
• The Shaw Group Inc., Nuclear Power Division

Remediation Projects

- American DND Inc.
• Black & Veatch
• Studsvik, Inc

Remediation Services

- Black & Veatch
CS-2 Inc.
Eberline Services Inc.
Enercon Services, Inc.
MOTA Corporation
• Studsvik, Inc
• The Shaw Group Inc., Nuclear Power Division

Remediation: Groundwater

- Atomic Energy of Canada Limited
Enercon Services, Inc.

Rental: Equipment

E.H. Wachs Co.
Hydratight

Repair Equipment: Remote-Controlled

- Atomic Energy of Canada Limited
E.H. Wachs Co.
Hydratight

Repair: Apparatus

- Schulz Electric Company

Repair: General Equipment

- Bartlett Holdings, Inc.
E.H. Wachs Co.
• Schulz Electric Company

Repairs: Underwater

- Hydratight
• Underwater Construction Corporation

Resin Services: Ion Exchange

Epicor, Inc.

Resistance Temp. Detector Modifications

- Mirion Technologies
RDF Corporation

Resistance Temperature Detectors

- Mirion Technologies
Temp-Pro Inc.
Wyle Laboratories, Inc.

Respirator Cleaning Equipment

- American Airworks
• UniTech Services Group, Inc., Div. of Unifirst Corp.

Respirator Supply Systems

- UniTech Services Group, Inc., Div. of Unifirst Corp.

Respirators

- Draeger Safety, Inc.
LANCS Industries, Inc.
• UniTech Services Group, Inc., Div. of Unifirst Corp.

Retubing

- Powerfect
• Westerman Nuclear

Reverse Osmosis

MPW Industrial Services, Inc.

Review Support: Operational Readiness

- Bartlett Holdings, Inc.
• Black & Veatch
Conger & Elsea, Inc.

- EXCEL Services Corporation
EXPONENT
- Reviews: Management Consulting**
Bartlett Holdings, Inc.
- Rigging**
- Bigge Power Constructors
Rigging International
Western Sling And Supply Company
- Rings: Rolled**
- Trust Manufacturing
- Risk Assessment**
ABS Consulting
Bartlett Holdings, Inc.
EXPONENT
Scientech
- Risk Assessment: Outage Financial**
- Black & Veatch
- Risk Assessment: Outage Shutdown Safety**
- EXCEL Services Corporation
- Robotic Handling Equipment**
Morris Material Handling (P&H)
R. Brooks Associates, Inc.
R. Brooks Associates, Inc.
- Robotic Programs: Utility, Devel. and Implem.**
- Atomic Energy of Canada Limited
- Robots and Robotic Equipment**
- Atomic Energy of Canada Limited
ICM - International Climbing Machines
Pentek Decontamination Products DIV.
R. Brooks Associates, Inc.
R. Brooks Associates, Inc.
Staubli Corporation
Zetec, Inc.
- Rod Control Maintenance Services**
- Data Systems & Solutions SAS
Scientech
- Rolled Sections: Metal Alloys**
ATI Allvac
- Rope: Warning**
Biodex Medical Systems
Euclid Garment Manufacturing Company
- UniTech Services Group, Inc., Div. of Unifirst Corp.
- Rubber Products: Custom**
- Seal Master Corporation
Trentec, Inc.
- Safeguard Equipment**
- Data Systems & Solutions SAS
- Safeguards**
- Black & Veatch
• Canberra Industries, Inc.
Enercon Services, Inc.
ORTEC
- Safes/Vaults: Lead Shielded**
Biodex Medical Systems
- Safety Analysis**
- Atomic Energy of Canada Limited
CTR Technical Services, Inc.
- Data Systems & Solutions SAS
- EXCEL Services Corporation
Sargent & Lundy
Scientech
- The Shaw Group Inc., Nuclear Power Division
- The Shaw Group Inc., Nuclear Power Division
- WorleyParsons Group, Inc.
- Safety Assessment**
- Black & Veatch
• EXCEL Services Corporation
EXPONENT
- Proto-Power Corporation
Scientech
- Safety Equipment**
- Joseph Oat Corporation
LANCS Industries, Inc.
Scientech
- Safety Evaluations: Preparation**
- Black & Veatch
Conger & Elsea, Inc.
- EXCEL Services Corporation
EXPONENT
L.A. Grime and Associates, Inc., AcroServices

- Proto-Power Corporation
Sargent & Lundy
Scientech
- Safety Evaluations: Program Reviews**
- Black & Veatch
Conger & Elsea, Inc.
- EXCEL Services Corporation
EXPONENT
L.A. Grime and Associates, Inc., AcroServices
Sargent & Lundy
- Safety Management**
- Black & Veatch
• EXCEL Services Corporation
- Safety: Industrial**
Bartlett Holdings, Inc.
Black & Veatch
Conger & Elsea, Inc.
The Delphi Groupe, Inc.
- Safety: Radiological**
Bartlett Holdings, Inc.
Black & Veatch
The Delphi Groupe, Inc.
- Sample Collection**
- HI-Q Environmental Products Company
- Sampling Systems**
- HI-Q Environmental Products Company
- Sampling Systems: Iso-Kinetic**
Air Monitor Corp.
- HI-Q Environmental Products Company
- Sawing**
Cutting Edge Services Corporation
- Saws**
E.H. Wachs Co.
- Scabblers: Dustless Floor**
Pentek Decontamination Products DIV.
- Scabblers: Remotely Operated**
ICM - International Climbing Machines

- Scaffolding**
Bartlett Holdings, Inc.
- The Shaw Group Inc., Nuclear Power Division
- Scaffolding Erection Services**
Bartlett Holdings, Inc.
- The Shaw Group Inc., Nuclear Power Division
- Scaffolding Rental**
Bartlett Holdings, Inc.
- Scheduling**
MOTA Corporation
- Scintillation Crystals**
Saint-Gobain Crystals
Spectra Physics, Hilger Crystals Limited
- Seal Enclosures: Custom**
- Mirion Technologies
- Sealants: Pipe Thread**
Scientech
- Sealing Systems: Quick-Disconnect**
Scientech
Wyle Laboratories, Inc.
- Sealing: Fluid**
Scientech
- Sealing: Penetration**
- Mirion Technologies
Scientech
- Seals**
- Atomic Energy of Canada Limited
BW/IP International, Inc.
- Flowsolve Pump Division
HellermannTyton
- Pawling Engineered Products
- Seal Master Corporation
- Siemens Energy, Inc
Trentec, Inc.
- Seals: Bellows, Gate Valve**
- Seal Master Corporation
- Seals: Bellows, Globe Valve**
- Seal Master Corporation

**FACED WITH
DIFFICULT AND CRITICAL
SEALING CHALLENGES?**

**INSIST ON SEAL MASTER®
FABRIC-REINFORCED
INFLATABLE SEALS
TODAY...**

SLEEP BETTER TONIGHT!

WWW.SEALMASTER.COM

DESIGN ASSISTANCE PROGRAM



*"They're
Deucedly
Clever"*



**SEAL MASTER
CORPORATION**

368 Martinel Drive, Kent, OH 44240-4368 USA
800-477-8436 • 330-673-8410 • FAX 330-673-8242

Seals: Conduit

- Mirion Technologies
Scientech

Seals: Diaphragm

- Seal Master Corporation

Seals: Flat

- Pawling Engineered Products
Seal Master Corporation

Seals: Hydrostatic

Scientech

Seals: Inflatable

- Pawling Engineered Products
Scientech
- Seal Master Corporation
Trentec, Inc.

Seals: Steam Generator

Scientech

Security Management

Valnerability Assessment Team, Argonne National Laboratory

Security System Design

- Enercon Services, Inc.
- Proto-Power Corporation
Sargent & Lundy
Scientech

Security System Integrators

Enercon Services, Inc.
RTC Associates, Inc.

Security System Maintenance

RTC Associates, Inc.

Security System Upgrades

- Enercon Services, Inc.
- Proto-Power Corporation
RTC Associates, Inc.
Sargent & Lundy

Security Systems

- Black & Veatch
RTC Associates, Inc.

Scientech

Security: Hazards Analysis

- ABS Consulting
Black & Veatch
Sargent & Lundy
Scientech

Seismic Analysis

- ABS Consulting
- Atomic Energy of Canada Limited
EXPONENT
- Joseph Oat Corporation
- Nuclear Logistics, Inc.
- Proto-Power Corporation
Sargent & Lundy
- Schulz Electric Company
Scientech
- The Shaw Group Inc., Nuclear Power Division
Trentec, Inc.
Wyle Laboratories, Inc.

Seismic Analysis/Testing Equipment

- Black & Veatch
- Kinectrics Incorporated
Scientech
Southern Testing Services, a Division of ATC

Seismic Qualification

- ABS Consulting
- Black & Veatch
Enertech
Engine Systems, Inc.
EXPONENT
- Nuclear Logistics, Inc.
Nuthern International, Inc.
Sargent & Lundy
- Schulz Electric Company
Scientech
Southern Testing Services, a Division of ATC
Trentec, Inc.
Wyle Laboratories, Inc.

Seminars: ASME Code

- Black & Veatch

Sensors

RDF Corporation
Wyle Laboratories, Inc.

Sensors: Differential Pressure

- Nuclear Logistics, Inc.

Sensors: Flow

- Nuclear Logistics, Inc.

Sensors: Fluid Level

- Enertech
- Nuclear Logistics, Inc.

Sensors: Level

Delta M Corporation
Enertech

Sensors: Pressure

C.J. Enterprises Inc., Div. of C.J. Instruments, Inc.
Enertech

Sensors: Temperature

- Enertech
- Mirion Technologies
RDF Corporation
Temp-Pro Inc.
Weed Instrument

Separators

- Precision Custom Components, LLC
- Seal Master Corporation

Sheet Metal

ATI Wah Chang

Sheeting: Plastic

Herculite Products
Reef Industries, Inc.

Shielding

AT&F Nuclear, Inc, Division of American Tank and Fabricating

- Biodex Medical Systems
- Joseph Oat Corporation
LANCS Industries, Inc.
Nuclear Shielding Supplies & Service, Inc.

Shielding Analysis

- Holtec International
Sargent & Lundy
Scientech
WMG, Inc.

Shielding Information: Nuclear

- Frontier Technology Corporation
Nuclear Shielding Supplies & Service, Inc.
WMG, Inc.

Shielding Materials

Nuclear Shielding Supplies & Service, Inc.

Shielding Materials: Gamma

Nuclear Shielding Supplies & Service, Inc.

Shielding Materials: Lead Glass

Biodex Medical Systems
British Shielding Windows Ltd.

Shielding Materials: Neutron

- Ceradyne Boron Products, LLC
- Frontier Technology Corporation
Nuclear Shielding Supplies & Service, Inc.

Shielding Windows

British Shielding Windows Ltd.
Trentec, Inc.

Shielding: Custom

Biodex Medical Systems
Nuclear Shielding Supplies & Service, Inc.
Tri Nuclear Corporation

Shielding: Gamma

Gamma Products, Inc.
Nuclear Shielding Supplies & Service, Inc.

Shielding: High-Density Concrete

- Ceradyne Boron Products, LLC
Nuclear Shielding Supplies & Service, Inc.

Shielding: Lead

Biodex Medical Systems
LANCS Industries, Inc.
Tri Nuclear Corporation

Shielding: Lead Bricks

Biodex Medical Systems
LANCS Industries, Inc.

Specialty Seals and Gaskets

For over 30 years (mostly as Presray), we've supplied specialized inflatable and compression seals, O-rings, flat gaskets and other fabrications to the Nuclear Power Industry. Our certified QA program allows you to quickly source materials without the hassle of testing and dedicating parts on your own.

Call us today to discuss your specific application.

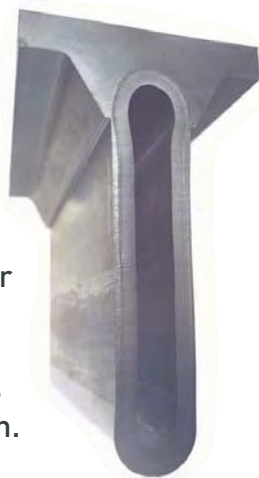

ph: 800-431-0101

www.pawling.com

Shielding: Neutron

Nuclear Shielding Supplies & Service, Inc.

Shielding: Portable

Biodex Medical Systems

LANCS Industries, Inc.

Nuclear Shielding Supplies & Service, Inc.

Tri Nuclear Corporation

Shielding: Radiation

Biodex Medical Systems

- Ceradyne Boron Products, LLC

LANCS Industries, Inc.

Nuclear Shielding Supplies & Service, Inc.

Tri Nuclear Corporation

Shielding: X-Ray

Nuclear Shielding Supplies & Service, Inc.

Shields: Bench-Top

Biodex Medical Systems

Shields: Lead Frisker

Container Products Corporation

Tri Nuclear Corporation

Shields: Mobile

Biodex Medical Systems

LANCS Industries, Inc.

Shields: Mobile Lead

Biodex Medical Systems

LANCS Industries, Inc.

Tri Nuclear Corporation

Shipping Containers: Neutron Source

- Frontier Technology Corporation

Shoe Covers: Protective

Euclid Garment Manufacturing Company

LANCS Industries, Inc.

- UniTech Services Group, Inc., Div. of Unifirst Corp.

Shredder/Compactors

Waste Control Systems, Inc.

Signal Conditioners

Acromag, Inc.

Wyle Laboratories, Inc.

Signs: Warning

Biodex Medical Systems

Coastal Network, Inc.

LANCS Industries, Inc.

Uticom Systems Inc.

Simulation Services

EXPONENT

Simulations: Real-Time

- Black & Veatch

Simulator Certification/Qualification

- EXCEL Services Corporation

Simulator Training

- Tecnatom, S.A.

Simulators: Power Plant

Fortum Nuclear Services Ltd.

VTT Technical Research Centre of Finland

Simulators: Structural Failure

ABS Consulting

Site Surveys

Enercon Services, Inc.

EXPONENT

Skimmers

Tri Nuclear Corporation

Sleeving

Apco Extruders Inc.

Reef Industries, Inc.

- UniTech Services Group, Inc., Div. of Unifirst Corp.

Sludge Collectors

Tri Nuclear Corporation

Sludge Lancing

- Babcock & Wilcox Canada

Sludge Removal

Diversified Technologies Services, Inc.

Sludge Vessels

Tri Nuclear Corporation

- Westerman Nuclear

Snubber Analysis

Sargent & Lundy

Wyle Laboratories, Inc.

Snubber Repair

Enertech

Wyle Laboratories, Inc.

Snubber Testing

Enertech

Wyle Laboratories, Inc.

Snubbers: Gauge

Wyle Laboratories, Inc.

Snubbers: Hydraulic

Enertech

Wyle Laboratories, Inc.

Snubbers: Mechanical

Wyle Laboratories, Inc.

Snubbers: Pressure

Wyle Laboratories, Inc.

Sodium Iodide Crystals

Saint-Gobain Crystals

Software

- Data Systems & Solutions SAS
- Sargent & Lundy

Software Conversion

- Data Systems & Solutions SAS

Software Development

- Black & Veatch
- Data Systems & Solutions SAS
- EXCEL Services Corporation
- Mirion Technologies
- Proto-Power Corporation
- Sargent & Lundy
- Trust Manufacturing
- Volian Enterprises, Inc.

Software Networking

Overhoff Technology Corporation

Software Validation

- CTR Technical Services, Inc.
- Data Systems & Solutions SAS
- EXCEL Services Corporation
- Proto-Power Corporation



We compete with the advantage of more than half a century of experience

Tecnatom: the technology of future



Inspection & Structural Integrity • Testing: Systems & Components Operability • Plant Operation Support
• Training Centres • Control Room & Man-Machine Interface Design • Development & Manufacture of Equipment
& Systems • Safety Management & Radiological Protection • New Nuclear Projects (Advanced Reactors, Fusion)

Since 1957

tecnatom, s. a.

correo@tecnatom.es - www.tecnatom.es

NPTS, Inc.

an Engineering, Design, and Construction Management firm has current and anticipated openings for the following positions:

- Licensing, USAR & Regulatory Engineers
- Engineering Design (All Disciplines)
- Sr. Project Managers (All Disciplines)
- Sr. Project Planners (All Disciplines)
- Power Upgrade Project Engineers
- Construction Management, Planners, Schedulers, Estimators
- Resident Engineers (All Disciplines)
- Operations Support Engineers
- Operations Training Instructors
- Procurement Specialists & Expeditors
- Start-up & Commissioning Engineers

For Power Uprates, New Builds, Life Extension, Upgrades, Modification and Maintenance Projects

Please forward Resumes to:

NPTS, Inc.
2060 Sheridan Drive
Buffalo, New York 14223
Phone: 716.876.8066
Fax: 716.876-8004
E-mail: rbroman@npts.net

Cf - 252

Neutron Sources

- NRC-Registered Standard Sources to 3.7 mg.
- Custom Sources
- Quality Sources for Industry, Research & Reactor Start-Up
- Also Available:
SbBe Pellets & Sources
Neutron-Source Shipping Containers - TYPE A - for Rental or Purchase
WEP Shielding

FRONTIER TECHNOLOGY CORPORATION

NRC License SNM-1957
 P.O. Box 486
 1641 Burnett Drive
 Xenia, Ohio 45385
 (937) 376-5691
 FAX: (937) 376-5692

Software Verification

- CTR Technical Services, Inc.
- Data Systems & Solutions SAS
- EXCEL Services Corporation
- Proto-Power Corporation

Software: Computer Graphics/Simulation

- Black & Veatch

Software: Custom

- CTR Technical Services, Inc.
- Research Software Consulting Group, Inc.
- Sargent & Lundy
- Volian Enterprises, Inc.
- WMG, Inc.

Software: Database Management

- EXCEL Services Corporation
- Sargent & Lundy
- Scientech
- Volian Enterprises, Inc.

Software: Document Control

- EXCEL Services Corporation
- Sargent & Lundy

Software: Eddy Current Testing

- Zetec, Inc.

Software: Engineering Applications

- Sargent & Lundy

Software: Environmental Monitoring

- TechniDATA AG

Software: Fatigue Monitoring

- Ventyx

Software: Fault Tree Analysis

- Conger & Elsea, Inc.
- Relcon Scandpower AB

Software: Finite Element Analysis

- Black & Veatch

Software: Fuel Management

- GE Hitachi Nuclear Energy
- TransWare Enterprises Inc.

Software: Health Physics

- Bartlett Holdings, Inc.
- Canberra Industries, Inc.
- Mirion Technologies

Software: Inventory Management

- Sargent & Lundy
- Scientech
- Ventyx

Software: Maintenance

- Sargent & Lundy
- Ventyx

Software: Materials Management

- Scientech

Software: Nuclear Safety

- EXCEL Services Corporation
- Fortum Nuclear Services Ltd.
- Scientech

Software: Operational Readiness

- Conger & Elsea, Inc.
- EXCEL Services Corporation

Software: Operations Management

- Ventyx

Software: Personnel Monitoring

- Mirion Technologies

Software: Personnel Qualification

- Ventyx

Software: Plant Modeling

- Black & Veatch
- Proto-Power Corporation
- Sargent & Lundy

Software: Plant Performance

- Proto-Power Corporation
- Scientech

Software: Power Systems Analysis

- Black & Veatch
- Proto-Power Corporation

Software: Probabilistic Safety Analysis

- ABS Consulting
- EXCEL Services Corporation
- Relcon Scandpower AB
- Scientech

Software: Process Control

- Proto-Power Corporation

Software: Project Management

- EXCEL Services Corporation

Software: Radiological Data Management

- Scientech
- WMG, Inc.

Software: Records Management

- Scientech

Software: Reliability Analysis

- EXCEL Services Corporation
- Relcon Scandpower AB

Software: Remote Handling

- R. Brooks Associates, Inc.

Software: Robotic System

- R. Brooks Associates, Inc.

Software: Root Cause Analysis

- ABS Consulting
- Conger & Elsea, Inc.
- EXCEL Services Corporation

Software: Trending

- Conger & Elsea, Inc.
- Scientech

Software: Waste Tracking

- Canberra Industries, Inc.
- WMG, Inc.

Solenoid Operated Valve Applications

- Enertech
- Nuclear Logistics, Inc.
- Valcor Engineering Corporation

Solenoid Operated Valve Diagnostics

- Valcor Engineering Corporation

Solenoid Operated Valve Repair

- Enertech
- Valcor Engineering Corporation

Solenoids

- Enertech
- Nuclear Logistics, Inc.
- Valcor Engineering Corporation
- Wyle Laboratories, Inc.

Sources: Radioactive

- Eberline Services Inc.
- Frontier Technology Corporation
- General Atomics Electronic Systems, Inc.

Spectrometry: Mass, Secondary Ion

- Mass Spec Services

Spectroscopy Systems

- Canberra Industries, Inc.
- ORTEC

Spectroscopy Systems: Alpha

- Canberra Industries, Inc.
- Mirion Technologies

Spectroscopy Systems: Computer-Based

- Bartlett Holdings, Inc.
- Canberra Industries, Inc.

Spectroscopy Systems: Gamma

- Canberra Industries, Inc.

Spectroscopy: Alpha

- Radiation Safety Institute of Canada

Spectroscopy: Gamma

- Mirion Technologies

Spectroscopy: Neutron

- Mirion Technologies

Spectroscopy: X-Ray Photoelectron

- Laboratory Services

Spent Fuel Storage Products

- AT&F Nuclear, Inc, Division of American Tank and Fabricating

- Atomic Energy of Canada Limited
- Babcock & Wilcox Canada
- Holtec International
- Precision Custom Components, LLC
- Reef Industries, Inc.

Spent Fuel Technology

- PTP Spent Fuel Services, LLC.

Spent Fuel: Reracking

- Holtec International

Spill Control

JRM Chemical, Inc.
Western Sling And Supply Company

Staff Augmentation—See Staff Support

- EXCEL Services Corporation
Scientech

Staff Support

- Bartlett Holdings, Inc.
- EXCEL Services Corporation
Laboratory Services
MOTA Corporation
- NPPTS, Inc.
RCM Technologies, Inc.
Sargent & Lundy

Staff Support: 10CFR20 Implementation

- EXCEL Services Corporation
The Delphi Groupe, Inc.

Staff Support: Craft Labor

- Bartlett Holdings, Inc.
- Black & Veatch
- Schulz Electric Company
- Siemens Energy, Inc

Staff Support: Decontamination

- Bartlett Holdings, Inc.
- UniTech Services Group, Inc., Div. of Unifirst Corp.

Staff Support: Designers

Sargent & Lundy

Staff Support: Engineering

- Bartlett Holdings, Inc.
- Black & Veatch
CTR Technical Services, Inc.
- EXCEL Services Corporation
ILD, Inc.
- Proto-Power Corporation
Sargent & Lundy
- Siemens Energy, Inc
Sonic Systems International, Inc.
The Delphi Groupe, Inc.
WMG, Inc.

Staff Support: Executive

- Black & Veatch
- EXCEL Services Corporation
Sargent & Lundy

Staff Support: Health Physics

- Bartlett Holdings, Inc.
- Millennium Services, Inc.
- Siemens Energy, Inc
The Delphi Groupe, Inc.

Staff Support: Industrial Hygiene

The Delphi Groupe, Inc.

Staff Support: Instrument Calibration

- G.D. Barri & Associates, Inc.

Staff Support: Instrument Repair

- G.D. Barri & Associates, Inc.

Staff Support: Instrumentation/Control

- Bartlett Holdings, Inc.
- EXCEL Services Corporation
- G.D. Barri & Associates, Inc.
Sargent & Lundy

Staff Support: Laundry Collection

- UniTech Services Group, Inc., Div. of Unifirst Corp.

Staff Support: Licensing

- EXCEL Services Corporation
- G.D. Barri & Associates, Inc.

Staff Support: Modifications

- G.D. Barri & Associates, Inc.
Sargent & Lundy

Staff Support: Nondestruction Examination

- Siemens Energy, Inc
Sonic Systems International, Inc.
- Zetec, Inc.

Staff Support: Operational Readiness Review

- Black & Veatch
- EXCEL Services Corporation
- G.D. Barri & Associates, Inc.
- Siemens Energy, Inc

Staff Support: Outage

- Bartlett Holdings, Inc.
- EXCEL Services Corporation
- G.D. Barri & Associates, Inc.

Sargent & Lundy

- Siemens Energy, Inc
- Sonic Systems International, Inc.
The Delphi Groupe, Inc.
- UniTech Services Group, Inc., Div. of Unifirst Corp.

Staff Support: Planners

- Bartlett Holdings, Inc.
- G.D. Barri & Associates, Inc.
Sargent & Lundy
Sonic Systems International, Inc.

Staff Support: Quality Assurance/Control

- EXCEL Services Corporation
National Inspection & Consultants, Inc.
Sargent & Lundy
Sonic Systems International, Inc.

Staff Support: Radiological

Bartlett Holdings, Inc.

Staff Support: Schedulers

- Bartlett Holdings, Inc.
- G.D. Barri & Associates, Inc.

Staff Support: Specialists

- Bartlett Holdings, Inc.
- G.D. Barri & Associates, Inc.

Staff Support: Technical

- CTR Technical Services, Inc.
- EXCEL Services Corporation
- Flowsolve Pump Division
- G.D. Barri & Associates, Inc.
Sargent & Lundy
WMG, Inc.

Staff Support: Technical Staff

Bartlett Holdings, Inc.

Standards: Calibration

- Air Liquide America Specialty Gases, LLC
- EXCEL Services Corporation
Wyle Laboratories, Inc.

Annual Editorial Schedule

January-February
International Trade & Waste & Fuel Management Issue

March-April
Plant Maintenance & PLEX Issue

May-June
Outage Mgmt. & Health Physics Issue

July-August
New Plants & Vendor Advertorial Issue

September-October
Plant Maintenance & Advanced Reactors Issue

November-December
Annual Product & Service Directory Issue





Enriching Career Opportunities

LES is building the National Enrichment Facility in southeastern New Mexico. We will use the world's most advanced centrifuge technology to enrich uranium for use in American power plants.

If doing important work is meaningful to you, go to **nefnm.com** to explore enriching career opportunities.

Send resume to:
LES Human Resources Dept.
PO Box 1789
Eunice, NM 88231

EMAIL:
mbenjamin@nefnm.com

FAX:
575.394.4747

EOE M/F/V/D

Now Hiring:
Construction Manager
Production Managers
Senior Project Managers
Manager of Project Controls
Maintenance Manager
Plant Support Director
Programs Manager





Quality Excellence

“Let Barri be your Sourcing Arm”

6860 W. Peoria Ave., Peoria, AZ 85345 • 623-773-0410 (O); 623-773-2924 (F)

For 19 years, we have provided engineers, project controls, designers, training development and technical support for the power industries, construction, A&E firms, & prime contractors to DOE, FEMA & Corps of Engineers.

Contract – Temporary – Direct

Standards: Reference

Air Liquide America Specialty Gases, LLC

Standby Gas Treatment Systems

- AAF International
- NUCON International, Inc.

Startup Services

- Bartlett Holdings, Inc.
- The Shaw Group Inc., Nuclear Power Division

Steam Generator Chemical Cleaning

- Atomic Energy of Canada Limited

Steam Generator Disposal

- Rigging International
- Studsvik, Inc

Steam Generator Engineering Services

- Babcock & Wilcox Canada

Steam Generator Maintenance

- Babcock & Wilcox Canada
- R. Brooks Associates, Inc.

Steam Generator Maintenance Equipment

E.H. Wachs Co.
Hydratight
Scientech

Steam Generator Replacement

Bechtel Power
Hydratight
Rigging International

Steam Generators

- Babcock & Wilcox Canada
- Precision Custom Components, LLC
- Western United Industries

Steam/Water Separators

- Joseph Oat Corporation
- Precision Custom Components, LLC

Steel Components

AT&F Nuclear, Inc, Division of American Tank and Fabricating

Energy & Process Corporation

Steel: Boron Containing

Bohler Bleche Sheet & Plate, Affl. of Bohler Blech GmbH, Murzzuschlag, Austria

Steel: Carbon

Energy & Process Corporation

Steel: Stainless

ATI Allvac
Bohler Bleche Sheet & Plate, Affl. of Bohler Blech GmbH, Murzzuschlag, Austria
Carpenter Technology Corp.
Energy & Process Corporation
• Trust Manufacturing

Storage Equipment

Lista International Corp.
Modern Equipment Company, Inc.
Reef Industries, Inc.

Storage Systems: Onsite

Modern Equipment Company, Inc.
Reef Industries, Inc.

Storage: Maintenance

Lista International Corp.

Storage: Spent Fuel

- Enercon Services, Inc.
- Holtec International
- Joseph Oat Corporation
- Precision Custom Components, LLC
- Welding Services Inc.

Strainers: Liquid

Croll-Reynolds Engineering Company Inc.
Energy & Process Corporation

Strainers: Self-Cleaning

- Aerofin Corporation

Strainers: Suppression Pool ECCS

- GE Hitachi Nuclear Energy
- Performance Contracting Inc. (PCI)

Stress Measuring System

American Stress Technologies
SOLTEC Corporation

Stress Relief Services

Hydratight

Strippable Coatings

Bartlett Holdings, Inc.

Structural Integrity Assessment

Sargent & Lundy

Stud Handling

Associated Technologies

Stud Refurbishment

- Trust Manufacturing

Stud Removal

Associated Technologies
Biach Industries, Inc.
E.H. Wachs Co.
Hydratight

Stud Tensioning Systems

- Associated Technologies
- Scientech
- Trust Manufacturing

Stud Tensioning: Pressure Vessel

- Associated Technologies
- Trust Manufacturing

Studs

- Energy & Process Corporation
- Niagara Fasteners Inc.
- Trust Manufacturing

Supplies: Asbestos Removal

LANCS Industries, Inc.

Support Services: Operating Plant

Sargent & Lundy

Surveillance: Motor Load

- Schulz Electric Company

**The PCI Sure-Flow®
Suction Strainer is
Bigger and Better!**

The flexible, adaptable PCI Sure-Flow® Strainer technology can put more surface area in the plant space allocated than any other competing ECCS screen system. More surface area means easier compliance to RG 1.82 Rev. 3 requirements. Send email to jim.bleigh@pcg.com for more information.

Other PCI systems include the NUKON® blankets, metal fabricated specialties, Q-materials, and insulation and accessories.



PERFORMANCE CONTRACTING, INC.,
ENGINEERED SYSTEMS GROUP
16047 West 110th Street, Lenexa, KS 66219
Tel. (913) 928-2800 • Fax: (913) 907-0453
www.pcg.com - World-Class Construction®

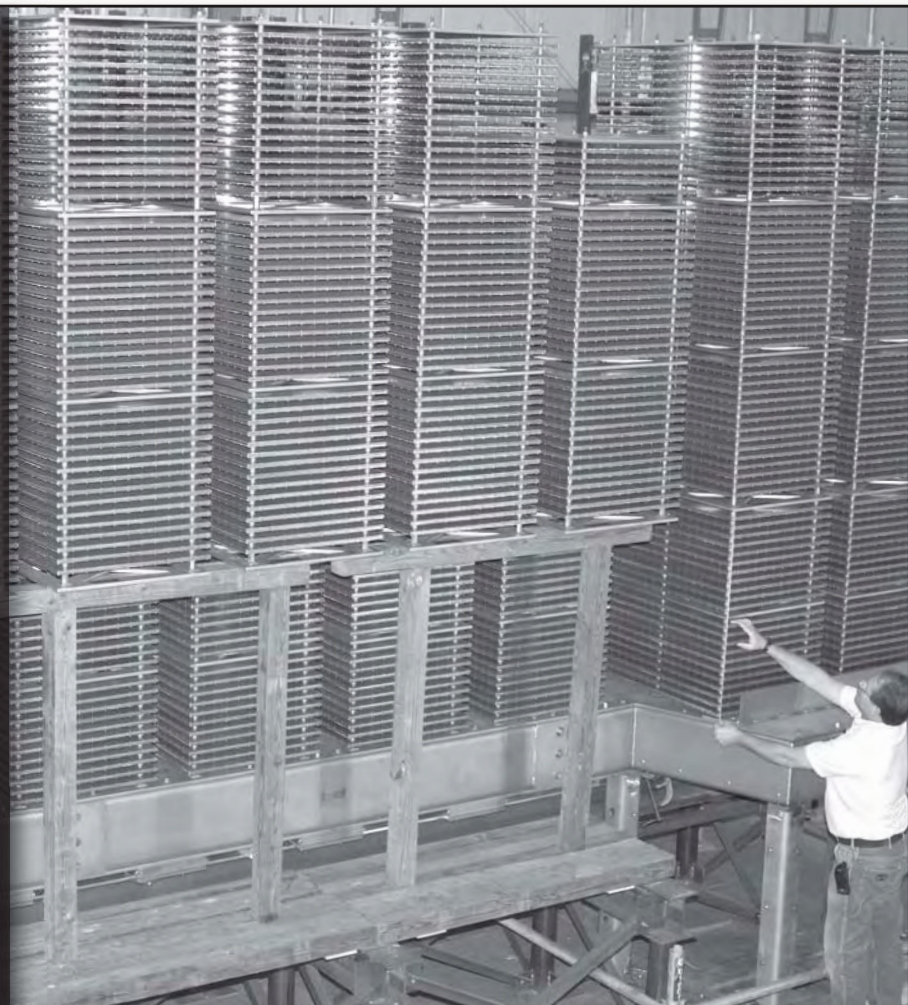



Focus (v) : to concentrate attention or effort

At Babcock & Wilcox Canada, we focus.

We focus our solutions to meet your unique requirements.

We pride ourselves on innovation and engineering excellence. Our nuclear steam generators have an outstanding performance record. Our replacement reactor vessel closure heads incorporate unique manufacturing processes to minimize residual stress. And our nuclear services for equipment inspection and maintenance keep your plant operating efficiently with minimal downtime.

Expertise. Attention to detail. Focus. Our approach delivers outstanding results.



Surveillance: Vendor

Quality Inspection Services, Inc

Swipes: Decontamination

Coastal Network, Inc.
LANCS Industries, Inc.

- Mohawk Industrial & Nuclear Supply, Inc.
- UniTech Services Group, Inc., Div. of Unifirst Corp.

Switchboards: Safety-Related

- Nuclear Logistics, Inc.
- Nutherm International, Inc.
- Scientech
- Trentec, Inc.

Switches: Differential Pressure

- Enertech
- Nuclear Logistics, Inc.
- Wyle Laboratories, Inc.

Switches: Flow

- Delta M Corporation
- Enertech
- Nuclear Logistics, Inc.
- Scientech
- Wyle Laboratories, Inc.

Switches: Level

- Delta M Corporation
- Enertech
- Nuclear Logistics, Inc.
- Scientech
- Wyle Laboratories, Inc.

Switches: Limit

- Nuclear Logistics, Inc.
- Scientech
- Wyle Laboratories, Inc.

Switches: Pressure

- Enertech
- Nuclear Logistics, Inc.

Switches: Pressure, Safety-Related

- Enertech
- Nuclear Logistics, Inc.
- Nutherm International, Inc.
- Scientech
- Trentec, Inc.
- Wyle Laboratories, Inc.

Switches: Temperature, Safety-Related

- Enertech
- Nuclear Logistics, Inc.
- Nutherm International, Inc.
- Scientech
- Trentec, Inc.
- Wyle Laboratories, Inc.

Switches: Thermocouple

Wyle Laboratories, Inc.

Switchgear

- Nuclear Logistics, Inc.
- Trentec, Inc.
- Wyle Laboratories, Inc.

Switchgear Maintenance

- Nuclear Logistics, Inc.

Switchgear: Safety-Related

- Nuclear Logistics, Inc.
- Nutherm International, Inc.
- Scientech
- Trentec, Inc.
- Wyle Laboratories, Inc.

Systems: Decommissioning

ICM - International Climbing Machines

Systems: Filtration

- AAF International

Systems: Gas Processing

- NUCON International, Inc.

Systems: HVAC

- AAF International
- SSM Industries, Inc.

Tagging Services

Infosight Corp.

Tags

Infosight Corp.
Uticom Systems Inc.

Tank Heating Products

- Schulz Electric Company

Tanks: Chemical

Precision Custom Components, LLC

- Westerman Nuclear

Tanks: Pressure

- Aerofin Corporation
- Joseph Oat Corporation
- Precision Custom Components, LLC
- Westerman Nuclear

Tanks: Stainless Steel

Precision Custom Components, LLC
Tri Nuclear Corporation

- Westerman Nuclear

Tanks: Storage

- Joseph Oat Corporation
- Westerman Nuclear

Tape: Duct

- LANCS Industries, Inc.
- UniTech Services Group, Inc., Div. of Unifirst Corp.

Tape: Electrical

- Nuclear Logistics, Inc.
- Scientech

Tape: Hook & Loop

HellermannTyton

Tape: Warning

- Euclid Garment Manufacturing Company
- UniTech Services Group, Inc., Div. of Unifirst Corp.

Tarps

- Herculite Products
- LANCS Industries, Inc.
- UniTech Services Group, Inc., Div. of Unifirst Corp.

Technical Management Services

- Black & Veatch
- EXCEL Services Corporation

Technology Transfer

R. Brooks Associates, Inc.
Sargent & Lundy

Telemetry Systems

- Mirion Technologies

Television Systems: Closed-Circuit

- Mirion Technologies
- Thermo Fisher Scientific, Scientific Instrument Division
- CIDTEC Cameras & Imagers

Television Systems: Rad Hardened

- Intertest, Inc.
- Mirion Technologies
- Thermo Fisher Scientific, Scientific Instrument Division
- CIDTEC Cameras & Imagers

Television Systems: Underwater, Rad Hardened

- Intertest, Inc.
- Mirion Technologies
- Thermo Fisher Scientific, Scientific Instrument Division
- CIDTEC Cameras & Imagers

Tensioning Rings: Hand-Hole

Scientech

Tensioning Rings: Manway

Biach Industries, Inc.
Scientech

Terminal Blocks

Wyle Laboratories, Inc.

Terminal Blocks: Safety-Related

- Kinectrics Incorporated
- Nuclear Logistics, Inc.
- Nutherm International, Inc.
- Scientech
- Trentec, Inc.
- Wyle Laboratories, Inc.

Terminals: Safety-Related

- Nuclear Logistics, Inc.
- Nutherm International, Inc.
- Scientech

Test Chambers: Environmental

Quanta Laboratories

Test Loops

Wyle Laboratories, Inc.

Test Stands: Valve

Wyle Laboratories, Inc.

Testing

- Atomic Energy of Canada Limited
- Bartlett Holdings, Inc.
- Black & Veatch
- Southern Testing Services, a Division of ATC
- Spectrum Technologies, a Division of ATC
- Wyle Laboratories, Inc.

Testing: Acceptance

- Mass Spec Services
- NUCON International, Inc.
- Quanta Laboratories
- Scientech

Testing: Acoustic Emission

Laboratory Services

Testing: Chemical

- EXPONENT
- Herguth Laboratories
- Kinectrics Incorporated
- Laboratory Services
- The M&P Lab
- Wyle Laboratories, Inc.

Testing: Electrical

- EXPONENT
- Kinectrics Incorporated
- Schulz Electric Company
- Trentec, Inc.
- Wyle Laboratories, Inc.

Testing: Electrochemical

EXPONENT
Wyle Laboratories, Inc.

Testing: Infrared

- Schulz Electric Company

Testing: Inorganic

Mass Spec Services

Testing: Irradiation

Scientech

Testing: Laboratory

- EXPONENT
- Herguth Laboratories
- Kinectrics Incorporated
- Laboratory Services
- R&G Laboratories, Inc
- Scientech
- The M&P Lab
- Trentec, Inc.
- Wyle Laboratories, Inc.

Testing: LOCA Conditions

- Nuclear Logistics, Inc.
- Nutherm International, Inc.
- Scientech
- Trentec, Inc.
- Wyle Laboratories, Inc.

Testing: Local and Integrated Leak Rate

Trentec, Inc.

Testing: Mechanical

- EXPONENT
- Kinectrics Incorporated
- Quanta Laboratories
- Scientech
- The M&P Lab
- Wyle Laboratories, Inc.

Testing: Mechanical & Irradiation

Scientech
Wyle Laboratories, Inc.

Testing: Mechanical, Fatigue

Quanta Laboratories

Testing: Mechanical, Fracture

Quanta Laboratories

Testing: Metallurgical

- EXPONENT
- Laboratory Services
- The M&P Lab
- Wyle Laboratories, Inc.

Testing: Overload Relay

Trentec, Inc.
Wyle Laboratories, Inc.

Testing: Remote Visual

Intertest, Inc
R. Brooks Associates, Inc.

Testing: Resistivity

Wyle Laboratories, Inc.

Testing: Safety-Related Components

Energy & Process Corporation
Engine Systems, Inc.

Mass Spec Services

- Nuclear Logistics, Inc.
- NUCON International, Inc.
- Nutherm International, Inc.
- Schulz Electric Company
Scientech
Trentec, Inc.
- Wyle Laboratories, Inc.

Testing: Special

- Atomic Energy of Canada Limited
Herguth Laboratories
ILD, Inc.
Laboratory Services
Mass Spec Services
Wyle Laboratories, Inc.

Thermal Shield Repair

- Underwater Construction Corporation

Thermocouple Attachment Units

Hydratight

- Mirion Technologies

Thermocouples

- Delta M Corporation
- Mirion Technologies
RDF Corporation
- Siemens Energy, Inc
Temp-Pro Inc.
Wyle Laboratories, Inc.

Thermocouples: In-Core

- Mirion Technologies
- Nuclear Logistics, Inc.
Nutherm International, Inc.

Thermocouples: In-Core, Replacement

- Mirion Technologies

Thermocouples: Safety-Related

- Mirion Technologies
- Nuclear Logistics, Inc.
Nutherm International, Inc.
Wyle Laboratories, Inc.

Thermometers

RDF Corporation

Titanium

ATI Allvac
Valtimet Inc.

Tooling: Underwater

E.H. Wachs Co.

- Underwater Construction Corporation

Tools: Control Rod Drive Handling

Scientech

Tools: Coupling

- Flowserve Pump Division

Tools: Fabrication

E.H. Wachs Co.

Hydratight

- Kinectrics Incorporated

Tools: Fuel Pin Transfer

- Underwater Construction Corporation

Tools: Hydraulic

E.H. Wachs Co.

Hydratight

Tools: Inspection

- Atomic Energy of Canada Limited
- GE Hitachi Nuclear Energy
Intertest, Inc
- Kinectrics Incorporated

Tools: LPRM Handling

Scientech

Tools: Maintenance

- Atomic Energy of Canada Limited
- Climax Portable Machine Tools, Inc.

E.H. Wachs Co.

- Flowserve Pump Division
Hydratight

Tools: Pipe Beveling

- Climax Portable Machine Tools, Inc.

E.H. Wachs Co.

Hydratight

- Tri Tool Inc.

Tools: Pipe Cutting

E.H. Wachs Co.

Hydratight

Tools: Remote Handling

- Atomic Energy of Canada Limited
MOTA Corporation

Tools: Robotic

- GE Hitachi Nuclear Energy

Tools: Tubing Cutting

E.H. Wachs Co.

Hydratight

Tools: Tubing, End Squaring

E.H. Wachs Co.

Hydratight

Tools: Tubing: Squaring

E.H. Wachs Co.

Hydratight

Tracer Gas Testing

- NUCON International, Inc.

Training Aids

- Design Assistance Corporation
Supersaturated Environments, (Div. of Reflection
Imaging, Inc.)

Training Support

American Triex, Inc.

Argonne National Laboratory

- EXCEL Services Corporation
Sargent & Lundy

Training: ANSI/ASME N510

- NUCON International, Inc.

Training: Appraisal

American Triex, Inc.

Training: Chemistry

Scientech

Training: Computer-Based

L.A. Grime and Associates, Inc., AcroServices

The Macris Group

Training: Computer-Based, Health Physics

- Mirion Technologies

Training: Diesel Generators

Engine Systems, Inc.

Training: Dosimetry

- Mirion Technologies

Training: Eddy Current Testing

- Zetec, Inc.

Training: Employee Concerns Programs

Conger & Elsea, Inc.

Training: Engineering

- EXCEL Services Corporation

Training: Environmental Management

- Canberra Industries, Inc.

Training: Failure Analysis

Conger & Elsea, Inc.

Training: Field

- Schulz Electric Company

Training: Fitness-for-Duty

American Triex, Inc.

Training: Health Physics

Applied Consultants, Inc.

- Canberra Industries, Inc.
Pacific Radiation Corporation

Training: Human Performance Improvement

Conger & Elsea, Inc.

Human and Organizational Performance Improvement

Training: Incident Investigation

Conger & Elsea, Inc.

Human and Organizational Performance Improvement

Training: INPO

Excelsior College

Training: Inspection

Conger & Elsea, Inc.

- Schulz Electric Company

Training: Instrumentation/Control

- Data Systems & Solutions SAS

Training: Maintenance

Biach Industries, Inc.

- Climax Portable Machine Tools, Inc.
- Data Systems & Solutions SAS
Design Assistance Corporation
- Flowserve Pump Division
- Schulz Electric Company

Training: Management

Excelsior College

Training: Management Consulting

- EXCEL Services Corporation

Training: Management Oversight

- EXCEL Services Corporation

Training: Management's Role in Safe Operation

- EXCEL Services Corporation

Training: Metallurgical

ATI Wah Chang

Training: Nondestructive Testing

IHI Southwest Technologies, Inc.

Sonic Systems International, Inc.

Training: Nuclear Counting Methods

- Canberra Industries, Inc.

Training: Nuclear Equipment Maintenance

- Canberra Industries, Inc.
- Climax Portable Machine Tools, Inc.
- Ludlum Measurements, Inc.
- Nuclear Logistics, Inc.
- Schulz Electric Company
WM B. Johnson & Associates Inc.
Wyle Laboratories, Inc.

Training: Nuclear Materials

Wyle Laboratories, Inc.

Training: Nuclear Operations

- EXCEL Services Corporation

Training: Nuclear Safety

Atlantic Nuclear Services Ltd.

- Canberra Industries, Inc.
CTR Technical Services, Inc.
- EXCEL Services Corporation

Training: Nuclear Simulator

Scientech

- Tecnatom, S.A.

Training: Operational Readiness

Conger & Elsea, Inc.

Training: Operations Personnel

Scientech

Training: Presentation Methods

Conger & Elsea, Inc.

Training: Probabilistic Safety Analysis

- EXCEL Services Corporation
Relcon Scandpower AB

Training: Procedure Writing

- EXCEL Services Corporation

Training: Procurement

Scientech

Training: Program Development Services

The Delphi Groupe, Inc.

Training: Project Management

- EXCEL Services Corporation

Training: Quality Assurance

- EXCEL Services Corporation
Sargent & Lundy
Sonic Systems International, Inc.

Training: Quality Auditor

Conger & Elsea, Inc.

- EXCEL Services Corporation
Sonic Systems International, Inc.

- Training: Quality Control**
 - EXCEL Services Corporation
 - Sonic Systems International, Inc.
- Training: Quality Improvement**
 - Sargent & Lundy
- Training: Radiation Fundamentals**
 - Supersaturated Environments, (Div. of Reflection Imaging, Inc.)
- Training: Radiation Monitoring Systems**
 - Berkeley Nucleonics Corp.
 - Canberra Industries, Inc.
 - General Atomic Electronic Systems, Inc.
 - Mirion Technologies
 - WM B. Johnson & Associates Inc.
- Training: Radiation Protection**
 - Pacific Radiation Corporation
- Training: Radiation Safety**
 - Pacific Radiation Corporation
- Training: Radioactive Materials Handling**
 - WMG, Inc.
- Training: Regulations**
 - EXCEL Services Corporation
- Training: Risk Analysis**
 - Conger & Elsea, Inc.
- EXCEL Services Corporation
- Training: Risk Assessment**
 - Conger & Elsea, Inc.
- EXCEL Services Corporation
- Training: Risk Tree**
 - Conger & Elsea, Inc.
- Training: Root Cause Analysis**
 - Conger & Elsea, Inc.
- EXCEL Services Corporation
- Training: Safety Evaluations**
 - Conger & Elsea, Inc.
- EXCEL Services Corporation
- L.A. Grime and Associates, Inc., AcroServices
- Scientech
- Training: Security**
 - Valnerability Assessment Team, Argonne National Laboratory
- Training: Seismic**
 - Trentec, Inc.
 - Wyle Laboratories, Inc.
- Training: Software**
 - WMG, Inc.
- **Training: Spectroscopy**
 - Canberra Industries, Inc.
- Training: Standards**
 - Bartlett Holdings, Inc.
- Training: Team Leaders**
 - Conger & Elsea, Inc.
 - The Macris Group
- **Training: Technical Staff**
 - EXCEL Services Corporation
 - L.A. Grime and Associates, Inc., AcroServices
 - Sargent & Lundy
- Training: Valves & Valve Actuators**
 - Valcor Engineering Corporation
 - Wyle Laboratories, Inc.
- Training: Waste Management**
 - Argonne National Laboratory
 - WMG, Inc.
- Transducers**
 - Enertech
- Transducers: Acceleration**
 - Pace Transducer Company/C.J. Enterprises
- Transducers: Displacement**
 - C.J. Enterprises Inc., Div. of C.J. Instruments, Inc
 - Pace Transducer Company/C.J. Enterprises
 - Wyle Laboratories, Inc.
- Transducers: Heat Flux**
 - International Thermal Instrument Corporation
- Transducers: In-Line, High-Temperature**
 - Mirion Technologies

- Transducers: In-Line, Low-Temperature**
 - Mirion Technologies
- Transducers: Load**
 - C.J. Enterprises Inc., Div. of C.J. Instruments, Inc
 - Pace Transducer Company/C.J. Enterprises
- Transducers: Pressure**
 - C.J. Enterprises Inc., Div. of C.J. Instruments, Inc
 - Pace Transducer Company/C.J. Enterprises
 - Scientech
- Transducers: Safety-Related**
 - Nuclear Logistics, Inc.
 - Nutherm International, Inc.
 - Scientech
 - Trentec, Inc.
 - Wyle Laboratories, Inc.
- Transducers: Ultrasonic**
 - Interstest, Inc
 - Technisonic Research Inc.
- Transfer Switches: 1E**
 - Scientech
 - Wyle Laboratories, Inc.
- Transformer Replacement Services**
 - Rigging International
- Transformers**
 - Wyle Laboratories, Inc.
- Transformers: Safety-Related**
 - Engine Systems, Inc.
- Nuclear Logistics, Inc.
- Nutherm International, Inc.
- Scientech
- Trentec, Inc.
- Wyle Laboratories, Inc.
- Transmitters**
 - Acromag, Inc.
 - Wyle Laboratories, Inc.
- Transmitters: Radiation Monitors**
 - Mirion Technologies
- Transmitters: Diff. Press., Safety-Related**
 - Nutherm International, Inc.
 - Scientech
 - Weed Instrument
 - Wyle Laboratories, Inc.
- Transmitters: Humidity**
 - Elan Technical Corporation
- Transmitters: Level**
 - Enertech
- Transmitters: Personnel Dosimetry**
 - Mirion Technologies
- Transmitters: Pressure**
 - Pace Transducer Company/C.J. Enterprises
 - Weed Instrument
- Transmitters: Safety-Related**
 - Nuclear Logistics, Inc.
 - Nutherm International, Inc.
 - Scientech
 - Trentec, Inc.
 - Wyle Laboratories, Inc.
- Transmitters: Temperature**
 - Weed Instrument
- Transport: Heavy**
 - Rigging International
- Trending: Electric Machinery**
 - Schulz Electric Company
- Tritium Technologies**
 - Atomic Energy of Canada Limited
- Tube Bundle Components**
 - Precision Custom Components, LLC
- Tube Cutting Machinery**
 - E.H. Wachs Co.
 - Hydratight
- Tube End Finishing Machine**
 - E.H. Wachs Co.
 - Hydratight
- Tube Plug Qualification**
 - Babcock & Wilcox Canada

- Tube Plug Removal**
 - Babcock & Wilcox Canada
- Tube Plugging**
 - Babcock & Wilcox Canada
 - Powerfect
- Tubes: Geiger-Mueller**
 - Saint-Gobain Crystals, (SGC01)
- Tubes: Proportional**
 - Saint-Gobain Crystals, (SGC01)
- Tubing**
 - Black & Veatch
 - Energy & Process Corporation
 - Newage Industries, Inc.
 - Seal Master Corporation
 - Tioga Pipe Supply Company Inc.
 - Valtmet Inc.
 - Veridiam
- Tubing: Calandria**
 - Veridiam
 - Zircatec Precision Industries Inc.
- Tubing: Hafnium**
 - ATI Wah Chang
- Tubing: Metal**
 - ATI Wah Chang
- Tubing: Plastic**
 - LANCS Industries, Inc.
 - Newage Industries, Inc.
- Tubing: Stainless Steel**
 - Joseph Oat Corporation
 - Tioga Pipe Supply Company Inc.
 - Valtmet Inc.
 - Veridiam
- Tubing: Titanium**
 - Valtmet Inc.
 - Veridiam
 - Zircatec Precision Industries Inc.
- Tubing: Zirconium**
 - ATI Wah Chang
 - Zircatec Precision Industries Inc.
- Turbine Analysis**
 - Alstom Power
- Turbine Blades: Coating Services**
 - Alstom Power
 - Fuel Tank Maintenance Company LLC
- Turbine Blades: Weld Repairs**
 - Alstom Power
 - Climax Portable Machine Tools, Inc.
- Turbine Boresonic Examination**
 - Interstest, Inc
 - R. Brooks Associates, Inc.
- Turbine Generator Inspection**
 - Alstom Power
 - Bartlett Holdings, Inc.
- Turbine Generator Maintenance**
 - Alstom Power
 - Bartlett Holdings, Inc.
 - Climax Portable Machine Tools, Inc.
 - Energy Resources Group, Inc.
- Turbine Generators**
 - Alstom Power
 - Western United Industries
- Turbine Inspection**
 - Alstom Power
 - Bartlett Holdings, Inc.
 - R. Brooks Associates, Inc.
 - Stork H&E Turbo Blading
- Turbine Maintenance**
 - Alstom Power
 - ATI Wah Chang
 - Climax Portable Machine Tools, Inc.
 - Stork H&E Turbo Blading
- Turbine Outage Management**
 - Alstom Power
 - Bartlett Holdings, Inc.
 - Stork H&E Turbo Blading

CLEAN POWER TODAY!



Instead of imagining a better environment,
let us help you make it happen.

Our environmentally efficient technology is installed and working in thousands of power stations around the world. So, in partnership with our customers, we're already building a cleaner energy industry. You have the will. We have the way. Join us.

Visit www.power.alstom.com

We are shaping the future

ALSTOM

Turbines: Steam

Bartlett Holdings, Inc.
Stork H&E Turbo Blading
Western United Industries

UltraFiltration

Diversified Technologies Services, Inc.
Fuel Tank Maintenance Company LLC

Ultrasonic Flaw Detectors

Intertest, Inc

Ultrasonic Inspection

- Atomic Energy of Canada Limited
Intertest, Inc
- Zetec, Inc.

Ultrasonic Inspection System Development

- Intertest, Inc
- Kinectrics Incorporated

Ultrasonic Precision Gauging Systems

Intertest, Inc

Ultrasonic Scanning

- Intertest, Inc
- Zetec, Inc.

Ultrasonic Test Equipment

- Cygnus Instruments Inc.
Intertest, Inc
- Zetec, Inc.

Ultrasonic Test Standards

Intertest, Inc
Technisonic Research Inc.

Ultrasonic Testing Services

- IHI Southwest Technologies, Inc.
Intertest, Inc
- Siemens Energy, Inc

Uninterruptible Power Supplies

- Data Systems & Solutions SAS

Uninterruptible Power Supplies: Service

- Data Systems & Solutions SAS

Uninterruptible Power Supply: Safety-Related

- AMETEK Programmable Power, Supporting Elgar Nuclear Equip.
- Data Systems & Solutions SAS
- Nuclear Logistics, Inc.
Nutherm International, Inc.
Scientech
Wyle Laboratories, Inc.

Uranium Management

- Black & Veatch

Vacuum Equipment

Blue Lake Products
E.H. Wachs Co.
Minuteman International, Inc.

Vacuum Replacement Breakers: Medium-Voltage, Safety-Related

Nutherm International, Inc.

Vacuum Systems

E.H. Wachs Co.
Tri Nuclear Corporation

Vacuums: Underwater

MPW Industrial Services, Inc.
Tri Nuclear Corporation

Vacuums: HEPA-Filtered

- Blue Lake Products
Minuteman International, Inc.
Pentek Decontamination Products DIV.
- UniTech Services Group, Inc., Div. of Unifirst Corp.

Valve Actuator

- BW/IP International, Inc.
- Copes-Vulcan, An SPX Brand
E.H. Wachs Co.
Enertech
Flowsolve Flow Control Division
- Nuclear Logistics, Inc.
Scientech
- Siemens Energy, Inc
Valcor Engineering Corporation
Wyle Laboratories, Inc.

Valve Actuator Parts

- Enertech
Flowsolve Flow Control Division
- Nuclear Logistics, Inc.
Scientech

- Siemens Energy, Inc

Valve Actuator Repair

- Enertech
Flowsolve Flow Control Division
- Siemens Energy, Inc

Valve Actuators: Electric

- E.H. Wachs Co.
Flowsolve Flow Control Division
- Schulz Electric Company
Scientech
- SSM Industries, Inc.
Valcor Engineering Corporation

Valve Actuators: Electrohydraulic

- BW/IP International, Inc.
Enertech
- SSM Industries, Inc.

Valve Actuators: Electromechanical

- Scientech
- SSM Industries, Inc.

Valve Actuators: Hydraulic

- E.H. Wachs Co.
Enertech
Flowsolve Flow Control Division

Valve Actuators: Mechanical

- Scientech
- Seal Master Corporation

Valve Actuators: Pneumatic

- BW/IP International, Inc.
- Copes-Vulcan, An SPX Brand
E.H. Wachs Co.
Enertech
Scientech
- Seal Master Corporation
- SSM Industries, Inc.

Valve Analysis

- Black & Veatch
- Copes-Vulcan, An SPX Brand
EXPONENT
Scientech
Velan Valve Corporation
Wyle Laboratories, Inc.

Valve Assemblies

- BW/IP International, Inc.
- Copes-Vulcan, An SPX Brand
- Nuclear Logistics, Inc.
Valcor Engineering Corporation
Wyle Laboratories, Inc.

Valve Diagnostic Systems

- E.H. Wachs Co.
Valcor Engineering Corporation
Wyle Laboratories, Inc.

Valve Exercising

- E.H. Wachs Co.

Valve Flow Monitoring Systems

- Technology for Energy Corporation (TEC)

Valve Modification

- Copes-Vulcan, An SPX Brand
Welding Services Inc.

Valve Parts

- BW/IP International, Inc.
- Copes-Vulcan, An SPX Brand
Enertech
Flowsolve Flow Control Division
- Nuclear Logistics, Inc.
- Siemens Energy, Inc
- Trust Manufacturing
Velan Valve Corporation
Weir Valves and Controls, Formerly Atwood & Morrill Company, Inc.
Wyle Laboratories, Inc.

Valve Positioners

- Copes-Vulcan, An SPX Brand
Emerson Process Management
- Nuclear Logistics, Inc.
Scientech
- Siemens Energy, Inc
Wyle Laboratories, Inc.

Valve Reconditioning

- Climax Portable Machine Tools, Inc.
- Copes-Vulcan, An SPX Brand
- Siemens Energy, Inc

Valve Refurbishment

- Climax Portable Machine Tools, Inc.
- Copes-Vulcan, An SPX Brand
Enertech
Henry Pratt Company, Sub. of Mueller Co.
- Siemens Energy, Inc
Welding Services Inc.

Valve Repair

- Babcock & Wilcox Canada
BW/IP International, Inc.
- Climax Portable Machine Tools, Inc.
- Copes-Vulcan, An SPX Brand
Emerson Process Management
Enertech
Flowsolve Flow Control Division
Hydratight
- Siemens Energy, Inc
Weir Valves and Controls, Formerly Atwood & Morrill Company, Inc.
Welding Services Inc.

Valve Repair Equipment

- Climax Portable Machine Tools, Inc.
E.H. Wachs Co.
Hydratight
- Siemens Energy, Inc

Valve Service Supervision

BW/IP International, Inc.
Velan Valve Corporation

Valve Services

- Bartlett Holdings, Inc.
BW/IP International, Inc.
- Climax Portable Machine Tools, Inc.
- Copes-Vulcan, An SPX Brand
Enertech
Flowsolve Flow Control Division
- Siemens Energy, Inc
Weir Valves and Controls, Formerly Atwood & Morrill Company, Inc.
Welding Services Inc.

Valve Test Benches

- Climax Portable Machine Tools, Inc.

Valve Testing

- BW/IP International, Inc.
- Climax Portable Machine Tools, Inc.
EXPONENT
Wyle Laboratories, Inc.

Valve Testing Systems

- Climax Portable Machine Tools, Inc.

Valve Turning

E.H. Wachs Co.

Valves

- Argo Turboserve Corporation (ATC)
- Black & Veatch
BW/IP International, Inc.
- Copes-Vulcan, An SPX Brand
- DIVESCO, Inc.
Enertech
Flowsolve Flow Control Division
- Nuclear Logistics, Inc.
- Siemens Energy, Inc
Valcor Engineering Corporation
Val-Matic Valve & Manufacturing Corporation
Weir Valves and Controls, Formerly Atwood & Morrill Company, Inc.
Wyle Laboratories, Inc.

Valves: Air Operated Globe

- BW/IP International, Inc.
Conval Inc.
- Nuclear Logistics, Inc.
Valcor Engineering Corporation
Velan Valve Corporation

Valves: Ball

- Copes-Vulcan, An SPX Brand
Enertech
Flowsolve Flow Control Division
Henry Pratt Company, Sub. of Mueller Co.
- Nuclear Logistics, Inc.
Val-Matic Valve & Manufacturing Corporation
Velan Valve Corporation

Valves: Bellows Sealed

BW/IP International, Inc.
Conval Inc.
Enertech



COPES-VULCAN
AN SPX BRAND

Control for the Nuclear Industry

Globe ▪ Butterfly ▪ Ball ▪ Check ▪ Gate



At SPX, we listen to your requirements, our team visits your site and provides informed solutions for your specific application.

Our extensive line of valve types, actuation, controls and trims allows us to provide you with the best solution.

Exceeding your expectations is our goal.



SPX Flow Control
5620 West Road ▪ McKean, PA 16426
Phone: (814) 476-5826 ▪ Fax: (814) 476-5848



- Flowserve Flow Control Division
- Seal Master Corporation
- Valcor Engineering Corporation
- Velan Valve Corporation
- Valves: Butterfly**
- Copes-Vulcan, An SPX Brand
- DIVESCO, Inc.
- Enertech
- Flowserve Flow Control Division
- Henry Pratt Company, Sub. of Mueller Co.
- Siemens Energy, Inc
- Val-Matic Valve & Manufacturing Corporation
- Velan Valve Corporation
- Weir Valves and Controls, Formerly Atwood & Morrill Company, Inc.
- Valves: Check**
- BW/IP International, Inc.
- Copes-Vulcan, An SPX Brand
- DIVESCO, Inc.
- Enertech
- Flowserve Flow Control Division
- Valcor Engineering Corporation
- Val-Matic Valve & Manufacturing Corporation
- Velan Valve Corporation
- Weir Valves and Controls, Formerly Atwood & Morrill Company, Inc.
- Welding Services Inc.
- Valves: Control**
- Copes-Vulcan, An SPX Brand
- DIVESCO, Inc.
- Emerson Process Management
- Enertech
- Flowserve Flow Control Division
- HI-Q Environmental Products Company
- Welding Services Inc.
- Valves: Custom**
- BW/IP International, Inc.
- Copes-Vulcan, An SPX Brand
- Seal Master Corporation
- Valcor Engineering Corporation
- Valves: Diaphragm**
- BW/IP International, Inc.
- Copes-Vulcan, An SPX Brand
- DIVESCO, Inc.
- Seal Master Corporation
- Valcor Engineering Corporation
- Valves: Divorter**
- Valcor Engineering Corporation
- Valves: Emergency Service**
- Mirion Technologies
- Welding Services Inc.
- Valves: Explosive Actuated**
- Copes-Vulcan, An SPX Brand
- Mirion Technologies
- Valves: Flanged**
- Copes-Vulcan, An SPX Brand
- Velan Valve Corporation
- Valves: Gate**
- BW/IP International, Inc.
- Conval Inc.
- Copes-Vulcan, An SPX Brand
- DIVESCO, Inc.
- Enertech
- Flowserve Flow Control Division
- Valcor Engineering Corporation
- Velan Valve Corporation
- Weir Valves and Controls, Formerly Atwood & Morrill Company, Inc.
- Welding Services Inc.
- Wyle Laboratories, Inc.
- Valves: Globe**
- BW/IP International, Inc.
- Conval Inc.
- Copes-Vulcan, An SPX Brand
- DIVESCO, Inc.
- Enertech
- Flowserve Flow Control Division
- Valcor Engineering Corporation
- Velan Valve Corporation
- Weir Valves and Controls, Formerly Atwood & Morrill Company, Inc.
- Welding Services Inc.

- Valves: High-Pressure**
- BW/IP International, Inc.
- Conval Inc.
- Copes-Vulcan, An SPX Brand
- Enertech
- Flowserve Flow Control Division
- Valcor Engineering Corporation
- Velan Valve Corporation
- Weir Valves and Controls, Formerly Atwood & Morrill Company, Inc.
- Valves: Isolation**
- BW/IP International, Inc.
- Copes-Vulcan, An SPX Brand
- Enertech
- Flowserve Flow Control Division
- T. D. Williamson, Inc.
- Valcor Engineering Corporation
- Velan Valve Corporation
- Weir Valves and Controls, Formerly Atwood & Morrill Company, Inc.
- Valves: Knife Gate**
- Velan Valve Corporation
- Valves: Main Steam Isolation, Maintenance**
- BW/IP International, Inc.
- Climax Portable Machine Tools, Inc.
- Flowserve Flow Control Division
- Hydratight
- Weir Valves and Controls, Formerly Atwood & Morrill Company, Inc.
- Welding Services Inc.
- Valves: Metering**
- Valcor Engineering Corporation
- Valves: Motor Operated**
- BW/IP International, Inc.
- Copes-Vulcan, An SPX Brand
- Flowserve Flow Control Division
- Nuclear Logistics, Inc.
- Schulz Electric Company
- Velan Valve Corporation
- Weir Valves and Controls, Formerly Atwood & Morrill Company, Inc.
- Valves: Motor Operated, Engineering**
- Velan Valve Corporation
- Valves: Needle**
- HI-Q Environmental Products Company
- Trust Manufacturing
- Valcor Engineering Corporation
- Velan Valve Corporation
- Valves: Packless**
- BW/IP International, Inc.
- Valcor Engineering Corporation
- Valves: Pilot**
- Valcor Engineering Corporation
- Valves: Plug**
- Copes-Vulcan, An SPX Brand
- DIVESCO, Inc.
- Henry Pratt Company, Sub. of Mueller Co.
- Val-Matic Valve & Manufacturing Corporation
- Valves: Pressure Relief**
- Enertech
- Valves: Relief**
- DIVESCO, Inc.
- Enertech
- Valves: Reseating Equipment**
- Hydratight
- Valves: Safety Relief, Maintenance**
- Welding Services Inc.
- Valves: Safety-Related**
- BW/IP International, Inc.
- Copes-Vulcan, An SPX Brand
- Enertech
- Flowserve Flow Control Division
- Mirion Technologies
- Nuclear Logistics, Inc.
- Nutherm International, Inc.
- Schulz Electric Company
- Sciencetech
- Trentec, Inc.
- Valcor Engineering Corporation
- Velan Valve Corporation

- Welding Services Inc.
- Valves: Sampling**
- Copes-Vulcan, An SPX Brand
- Valcor Engineering Corporation
- Valves: Solenoid**
- DIVESCO, Inc.
- Enertech
- Valcor Engineering Corporation
- Valves: Steam Conditioning**
- Copes-Vulcan, An SPX Brand
- Emerson Process Management
- Weir Valves and Controls, Formerly Atwood & Morrill Company, Inc.
- Vehicles: Cask Transport**
- J&R Engineering Company, Inc.
- Vehicles: Remotely-Operated**
- ICM - International Climbing Machines
- Vessel Fabrication**
- Joseph Oat Corporation
- Precision Custom Components, LLC
- Video Inspection Services**
- Hennigan Engineering Company, Inc.
- Intertest, Inc
- Powerfect
- R. Brooks Associates, Inc.
- Siemens Energy, Inc
- Video Inspection Systems**
- Intertest, Inc
- Mirion Technologies
- Siemens Energy, Inc
- Thermo Fisher Scientific, Scientific Instrument Division CIDTEC Cameras & Imagers
- Viewing Systems: Through-Wall**
- Mirion Technologies
- Voltage Regulators: Safety-Related**
- Nutherm International, Inc.
- Wyle Laboratories, Inc.
- Washers: Spherical**
- Trust Manufacturing
- Waste Analysis Systems**
- WMG, Inc.
- Waste Characterization**
- Canberra Industries, Inc.
- Eberline Services Inc.
- Enercon Services, Inc.
- WMG, Inc.
- Waste Encapsulation**
- Ceradyne Boron Products, LLC
- Diversified Technologies Services, Inc.
- NSSI/Recovery Services Inc.
- Waste Management Services**
- ANSALDO NUCLEARE SPA
- AREVA Inc., AREVA NC Inc.
- Atomic Energy of Canada Limited
- Studsvik, Inc
- WMG, Inc.
- Waste Processing**
- Enercon Services, Inc.
- Studsvik, Inc
- Waste Solidification**
- Ceradyne Boron Products, LLC
- Diversified Technologies Services, Inc.
- Waste Storage**
- Biodex Medical Systems
- NSSI/Recovery Services Inc.
- Waste: Liquid, Concentrators**
- Studsvik, Inc
- Waste: Mixed, Analysis**
- Canberra Industries, Inc.
- Sargent & Lundy
- Waste: Mixed, Management**
- Eberline Services Inc.
- NSSI/Recovery Services Inc.
- Water Filtration Equipment**
- Tri Nuclear Corporation
- Water Filtration Units**
- Underwater Construction Corporation

Water Management
EXPONENT**Water Treatment Services**
MPW Industrial Services, Inc.**Water Treatment: Waste**

- Studsvik, Inc

Waterblasting Equipment

Hennigan Engineering Company, Inc.
MPW Industrial Services, Inc.

Waterblasting/Hydrolasing Services

Hennigan Engineering Company, Inc.
MPW Industrial Services, Inc.

Weld Repair

- Black & Veatch
- Climax Portable Machine Tools, Inc.
- Joseph Oat Corporation
- Underwater Construction Corporation
- Welding Services Inc.

Welding

- Black & Veatch
- Climax Portable Machine Tools, Inc.
- GE Hitachi Nuclear Energy
- Joseph Oat Corporation
- Major Tool & Machine, Inc.
- Penn Iron Works, Inc.
- Precision Custom Components, LLC
- Westerman Nuclear

Welding Developments

Precision Custom Components, LLC

Welding Equipment

- Climax Portable Machine Tools, Inc.
- Weldstar Company

Welding Equipment: Orbital

Magnatech Limited Partnership

Welding Equipment: Remote

Magnatech Limited Partnership

Welding Materials

Central Wire
Nexarc Inc.
Weldstar Company

Welding: ASME Code

AT&F Nuclear, Inc, Division of American Tank and
Fabricating

- Black & Veatch
- Energy & Process Corporation
- Joseph Oat Corporation
- Penn Iron Works, Inc.
- Precision Custom Components, LLC
- Trentec, Inc.
- Underwater Construction Corporation
- Weldstar Company
- Westerman Nuclear

Welding: Automated

- Climax Portable Machine Tools, Inc.
- Magnatech Limited Partnership
- Precision Custom Components, LLC
- Westerman Nuclear

Welding: Hardfacing

Precision Custom Components, LLC
Weldstar Company

Welding: Narrow Groove, Automatic

Precision Custom Components, LLC
Welding Services Inc.

Welding: Overlay, Automatic

Precision Custom Components, LLC
Welding Services Inc.

Welding: Pipe & Pipe Fitting

Magnatech Limited Partnership

- Trust Manufacturing

Welding: Remote

Magnatech Limited Partnership

Welding: Special

Precision Custom Components, LLC

- Siemens Energy, Inc
- Welding Services Inc.

Welding: Underwater Wet

- Underwater Construction Corporation

Welding: Valve

- Climax Portable Machine Tools, Inc.
- Welding Services Inc.

Windows: Clear Lead Viewing

British Shielding Windows Ltd.

Windows: Radiation Instrument

Alexander Vacuum Research, Inc.

Wipes: Decontamination

- UniTech Services Group, Inc., Div. of Unifirst Corp.

Wiping Cloths

- UniTech Services Group, Inc., Div. of Unifirst Corp.

Wire Cloth

McNichols Company
Newark Wire Cloth Company

Wire: Consumable

Nexarc Inc.

Wire: Hot Rolled

Carpenter Technology Corp.

Wire: Nickel Alloy

Carpenter Technology Corp.
Central Wire
Nexarc Inc.

Wire: Safety-Related

- Nuclear Logistics, Inc.
- Nutherm International, Inc.
- Rockbestos-Surprenant Cable Corporation

Wire: Stainless

Carpenter Technology Corp.
Central Wire
Nexarc Inc.

Wireless Remote Systems: Dosimetry

Thermo Scientific

Wireless Remote Systems: Radiation Monitors

Thermo Scientific

Wood, fire retardant treated

Arch Wood Protection

Workstations

Lista International Corp.

Writing: Procedure

Bartlett Holdings, Inc.

X-Ray Diffraction Equipment

American Stress Technologies

- LND, Inc.
- Technology for Energy Corporation (TEC)

X-Ray Fluorescence Equipment

- LND, Inc.
- Warrington, Inc.

X-Ray Inspection Systems: Security

Spectra Physics, Hilger Crystals Limited

Zirconium

ATI Wah Chang

- Joseph Oat Corporation

Zirconium Alloy Mill Products

ATI Wah Chang

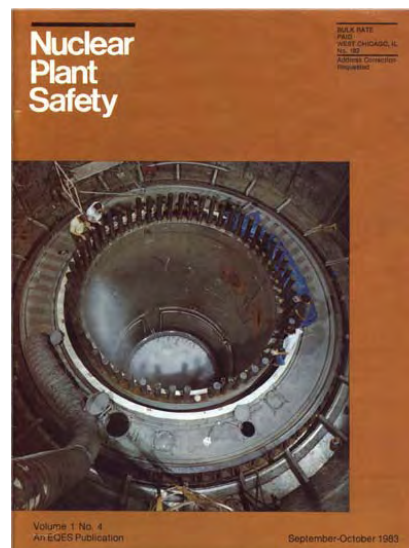
Historical NPJ Cover

September-October 1983

Volume 1, Issue 4

Core spray pattern examination during emergency core cooling system tests.
General Electric Company

Historical NPJ Cover

November-December 1983

Volume 1, Issue 5

Drawer containing fuel and other materials at Argonne National Lab's Zero Power Plutonium Reactor.
Argonne National Laboratory

Corporate Capabilities

• Denotes advertiser

- **AAF International,**
P.O. Box 35690, Louisville, KY 40232-5690; Phone: (502) 637-0279, Fax: (502) 637-0141, [Http://www.aafintl.com](http://www.aafintl.com), Email: jmagner@aafintl.com, Contact: Joe Magner.
(See advertisement on page 44)

Adsorber Cells: Charcoal
Adsorbers
Air Filtration Units
Air Handling Units
Carbon: Activated
Chillers
Coils: Cooling
Condensing Units: Air Cooled
Condensing Units: Water Cooled
Coolers: Containment
Coolers: Cubicle Coolers
Coolers: Drywell
Coolers: Fan Coil Units
Filter Elements
Filter Housings
Filter Refills
Filter Systems
Filters
Filters: Absolute Rated
Filters: Activated Carbon
Filters: Air
Filters: ASME Code
Filters: Bag
Filters: Charcoal
Filters: Disposable
Filters: Gas
Filters: HEPA
Filters: Pleated
Filters: Radwaste
Filters: Reactor Containment Vent
Filtration Equipment
Filtration Media: Carbon
Housings: Filter
HVAC: Ventilation Equipment
Off-Gas Systems
Standby Gas Treatment Systems
Systems: Filtration
Systems: HVAC



Advent Engineering Services, Inc.,
Domino's Farms, P.O. Box 555, Ann Arbor, MI 48106; Phone: (734) 930-7500, Fax: (734) 327-7501, [Http://www.adventengineering.com](http://www.adventengineering.com), Email: dcw@adventengineering.com, Contact: Douglas Wood.

Aging Management
Audits: Quality
Consulting: Appendix R
Consulting: Configuration Management
Consulting: Design Basis Documentation
Consulting: Engineering
Consulting: FSAR Licensing Review
Consulting: Licensing
Consulting: Life Cycle Management
Consulting: Technical Assessments
Design Basis Reconstitution

Engineering Services
Engineering: Design
Engineering: Systems
Environmental Qualification
Licensing Support Services
Maintenance Program Evaluation

- **Aerofin Corporation,**
4621 Murray Pl., Lynchburg, VA 24502; Phone: (434) 845-7081, Fax: (434) 528-6281, [Http://www.aerofin.com](http://www.aerofin.com), Email: belliott@aerofin.com, Contact: Brian Elliott.
(See advertisement on page 48)

Coils: Cooling
Coils: Heating
Coolers: Containment
Coolers: Drywell
Heat Exchangers
Heat Exchangers
Heat Exchangers: Rebuilding
Heat Exchangers: Retubing
Heat Exchangers: Shell
Strainers: Self-Cleaning
Tanks: Pressure

- **American Crane & Equipment Corp.,**
531 Old Swede Rd., Douglassville, PA 19518; Phone: (610) 385-6061ext 224, Fax: (610) 385-3191, [Http://www.americancrane.com](http://www.americancrane.com), Email: sales@americancrane.com, Contact: Karen Norheim.
(See advertisement on page 33)

Analysis: Engineering
Analysis: Structural
Crane Control Systems
Crane Controls
Crane Retrofits
Crane Retrofits: Single-Failure-Proof
Crane Service
Cranes
Cranes: Anti-Collision Systems
Cranes: Containment Polar
Cranes: Electric
Cranes: Fuel Building (Cask Handling)
Cranes: Fuel Pool
Cranes: Gantry
Cranes: Generically Licensable Type I
Cranes: Overhead
Cranes: Radio Controls
Cranes: Radwaste
Cranes: Safety System
Cranes: Single-Failure-Proof
Cranes: Type I
Hoists
Hoists: Radio Controls
Inspection Services
Lifting: Heavy
Materials Handling Equipment

American DND Inc.,
P.O. Box 553, Grand Island, NY 14072; Phone: (866) 699-5515, Fax: (716) 773-5515, [Http://www.AmericanDND.com](http://www.AmericanDND.com), Email: ADND@AmericanDND.com, Contact: Bill Schaab.

Concrete Cutting
Decommissioning Services
Decontamination
Environmental Remediation
Remediation Projects

- **ANSALDO NUCLEARE SPA,**
Corso Perrone, 25, Genova, 16152 Italy; Phone: +39 0106558212, Fax: +39 010 655 8415, [Http://www.ansaldonucleare.it](http://www.ansaldonucleare.it), Email: umberto.minopoli@ann.ansaldo.it, Contact: Umberto Minopoli.
(See advertisement on page 67)

Decommissioning Services
Fuel Handling Equipment
Plant Upgrading/Upgrading
Power Plants
Waste Management Services

- **AREVA Inc., AREVA NC Inc.,**
4800 Hampden Lane, Suite 1100, Bethesda, MD 20814-3416; Phone: (301) 841-1600, [Http://www.us.aveva.com](http://www.us.aveva.com), Email: cassie.hagan@areva.com, Contact: Cassie Hagan.
(See advertisement on page 2)

Design Services
Engineering: Nuclear
Fuel Management
Radwaste Handling
Waste Management Services

Argo Turboserve Corporation (ATC),
Cityview Corporate Center, 160 Chubb Avenue, Lyndhurst, NJ 07071; Phone: (201) 964-4153, Fax: (201) 507-1045, [Http://www.argoturbo.com](http://www.argoturbo.com), Email: dtенzer@argoturbo.com, Contact: Daniel Tenzer.

Electronic Components and Equipment
Instrumentation/Control Systems
Inventory Management
Outage Equipment
Parts: Procurement Assistance
Parts: Spare
Valves

- **AT&F Nuclear, Inc, Division of American Tank and Fabricating,**
12314 Elmwood Ave. NW, Cleveland, OH 44111; Phone: (800) 544-5316, Fax: (216) 252-4963, [Http://www.amtank.com](http://www.amtank.com), Email: cantrellk@amtank.com, moscardinir@amtank.com, Contact: Kevin Cantrell.
(See advertisement on page 14)

ASME Certificate Holder
Casks: Storage
Casks: Transport
Commercial-Grade Dedication
Containers: Radwaste
Containers: Storage
Containers: Transport
Containment Structures
Dampeners: Pulsation
Doors: Bullet Proof
Equipment: Bullet Resisting
Equipment: Safety-Related
Fabrication: Tubular Products
Fabrications
Heat Exchangers
Material: ASME Code
Metal Fabrication
Metal Fabrication: Stainless Steel
Metal Fabrication: Titanium
NPT Stamp Holder
Pipe Assemblies
Pressure Vessels
Reactor Internals
Reactor Vessel Components
Shielding
Spent Fuel Storage Products
Steel Components
Welding: ASME Code



- **Atomic Energy of Canada Limited,**
AECL-Sheridan Park, 2251 Speakman Dr., Mississauga L5K 1B2, Ontario Canada; Phone: (905) 823-9060, X7541, Fax: (905) 403-7565, [Http://www.aecl.ca](http://www.aecl.ca), Email: smithh@aecl.ca, Contact: Heather Smith.
(See advertisement on page 11)

3D Laser Scanning of Facilities
Analysis: Engineering
Analysis: Reactor Physics
Analysis: Stress
Analytical Services
Cherenko Viewing Devices (for nuclear safeguard)
Consulting
Consulting: Chemical Cleaning
Consulting: Chemical Decontamination
Consulting: Decommissioning
Consulting: Engineering
Consulting: Environmental
Consulting: Hazardous Waste Management
Consulting: Maintenance
Consulting: Materials Analysis
Consulting: Materials Engineering
Consulting: Metallurgical Analysis
Consulting: Nuclear
Consulting: Nuclear Fuel Cycles
Consulting: Plant Life Extension
Consulting: Radwaste
Consulting: Reactor Engineering
Consulting: Reactor Materials
Consulting: Reactor Safety
Consulting: Remote Systems Applications
Consulting: Research & Development
Consulting: Robotics
Consulting: Scientific
Consulting: Steam Generators
Consulting: Stress, Material
Consulting: Technical Assessments
Consulting: Thermal-Hydraulics
Consulting: Waste Management
Corrosion Control
Corrosion Testing Laboratory
Decommissioning Services
Decontamination
Decontamination Services
Design Services
ECC (Emergency Core Cooling) Strainers
Eddy Current Probes
Engineering Services
Engineering: Nuclear
Failure Analysis
Failure Analysis: Electron Microscopy
Fuel Analysis
Fuel Channels
Fuel Examination
Fuel Handling Equipment
Fuel Inspection
Heavy Water
Hot Cell Services
Hydrogen Removal/Purification Devices
Inspection Equipment: Robotic
Inspection: Primary-Side Components
Inspection: Steam Generator
Instrumentation: Nuclear
Lab Research: Materials
Maintenance Services
Metallography
Parts: Replacement, Design
Pumps
R&D Nondestructive Services
R&D Services
R&D: Fuel
R&D: Heat Transfer
R&D: Materials Performance
R&D: Nondestructive Testing
R&D: Robotics
R&D: Structural Mechanics
Reactor Services
Reactors: Engineering
Reactors: Heavy Water
Remediation: Groundwater
Repair Equipment: Remote-Controlled
Robotic Programs: Utility, Devel. and Implem.
Robots and Robotic Equipment
Safety Analysis

Seals
Seismic Analysis
Spent Fuel Storage Products
Steam Generator Chemical Cleaning
Testing
Testing: Special
Tools: Inspection
Tools: Maintenance
Tools: Remote Handling
Tritium Technologies
Ultrasonic Inspection
Waste Management Services

- **Babcock & Wilcox Canada,**
581 Coronation Blvd., Cambridge N1R 5V3, Ontario Canada; Phone: (519) 621-2130, Fax: (519) 622-3665, [Http://www.babcock.com](http://www.babcock.com), Email: jtang@babcock.com, Contact: Jun Tang.
(See advertisement on page 81)

Analysis: Dynamic
Analysis: Finite Element
Analysis: Stress
Analysis: Structural
Analysis: Thermal
Analysis: Vibration
Casks: Storage
Circuit Breaker Maintenance
Cleaning: Steam Generator
Construction Services
Consulting: Steam Generators
Diagnostics: Steam Generator
Eddy Current Testing Services
Engineering Services
Engineering: Field
Engineering: Nuclear
Handhole Repair Services
Heat Exchanger Analysis/Inspection Services
Heat Exchangers
Inspection: Steam Generator
Maintenance: Valves
Manufacturing Services
NDE Services
Nondestructive Testing & Evaluation
Pressure Vessel Analysis
Pressure Vessels
Pressurizers
R&D: Materials Performance
R&D: Metallurgy
Sludge Lancing
Spent Fuel Storage Products
Steam Generator Engineering Services
Steam Generator Maintenance
Steam Generators
Tube Plug Qualification
Tube Plug Removal
Tube Plugging
Valve Repair



- **Bartlett Holdings, Inc.,**
60 Industrial Park Rd., Plymouth, MA 02360; Phone: (508) 591-1149, Fax: (508) 746-3113, [Http://www.bartlettinc.com](http://www.bartlettinc.com), Email: lauren@bartlettinc.com, Contact: Lauren Buckman.

Air Filtration Units
ALARA Management Services
Characterization: Site
Coatings
Consulting
Consulting: Decommissioning
Consulting: Decontamination
Consulting: Health Physics
Consulting: Maintenance
Consulting: Planning & Scheduling
Consulting: Project Management
Consulting: Scaffolding Design/Engineering
Decommissioning Services
Decontamination Equipment
Decontamination Processes
Decontamination Services

Decontamination Supplies
Emergency Preparedness: Staff Support
Engineering Services
Engineering: Design
Engineering: Radiological
Engineering: Systems
Environmental Management
Environmental Remediation
Health Physics Services
Heat Exchanger Maintenance
HVAC: Ventilation Equipment
Inspection Services
Installation: Mechanical
Installation: Setup
Investigations: Pre-Employment Screening
Maintenance Services
Maintenance Support
Maintenance: Valves
Monitoring Systems: Remote
Motor Operators: Repair
Outage Support Services
Personnel Services
Radiological Protection Services
Repair: General Equipment
Review Support: Operational Readiness
Reviews: Management Consulting
Risk Assessment
Safety: Industrial
Safety: Radiological
Scaffolding
Scaffolding Erection Services
Scaffolding Rental
Software: Health Physics
Spectroscopy Systems: Computer-Based
Staff Support
Staff Support: Craft Labor
Staff Support: Decontamination
Staff Support: Engineering
Staff Support: Health Physics
Staff Support: Instrumentation/Control
Staff Support: Outage
Staff Support: Planners
Staff Support: Radiological
Staff Support: Schedulers
Staff Support: Specialists
Staff Support: Technical Staff
Startup Services
Strippable Coatings
Testing
Training: Standards
Turbine Generator Inspection
Turbine Generator Maintenance
Turbine Inspection
Turbine Outage Management
Turbines: Steam
Valve Services
Writing: Procedure

- **Bechtel Power,**
5275 Westview Drive, Frederick, MD 21703-8306; Phone: 301/228-8360, Fax: 301/696-0673, [Http://www.bechtel.com](http://www.bechtel.com), Email: afiorent@bechtel.com, Contact: Alan Fiorente.

Construction
Construction Services
Consulting: Nuclear
Design Services
Engineering Services
Engineering Services
Engineering: Nuclear
Engineering: Start-Up
Life Extension: Plant
Project Management
Quality Assurance
Reactor Head Removal Services
Regulatory Compliance: 10CFR50.59
Steam Generator Replacement

- **Bigge Power Constructors,**
10700 Bigge Ave., San Leandro, CA 94577; Phone: (510) 638-8100, Fax: (510) 639-4053, [Http://www.bigge.com](http://www.bigge.com), Email: gknopf@bigge.com, Contact: Gedge Knopf.
(See advertisement on page 6)

Construction Services
Crane Service
Cranes: Single-Failure-Proof

Decommissioning Services
 Reactor Head Removal Services
 Rigging

Biodex Medical Systems,

20 Ramsay Rd., Shirley, NY 11967; Phone: (800) 224-6339, Fax: (631) 205-2413, Http://www.biodex.com, Email: info@biodex.com, Contact: Lila Corwin.

Analyzers: Multichannel
 Barriers: Lead
 Blocks/Bricks: Lead
 Cabinets: Shielded
 Calibrators: Radioisotope Dose
 Carrier: Radionuclide
 Chromatography
 Containers: Lead
 Containers: Radwaste
 Containers: Shielded
 Containers: Storage Products
 Containers: Waste
 Counters: Alpha/Beta
 Counters: Gamma
 Counters: Radiation
 Counters: Wipe Test
 Counting Systems: Thyroid Uptake
 Decontamination Supplies
 Detectors: Gamma
 Detectors: Radiation
 Detectors: Scintillation
 Detergents: Contamination Removing
 Dosimeter Chargers
 Dosimeter Readers: Automatic Pocket
 Dosimeters: Direct Reading
 Dosimeters: Electronic Pocket
 Dosimeters: Personal
 Dosimeters: Radiation
 Eye/Face Protection
 Foil: Lead
 Gloves: Protective
 Instruments: Portable Survey
 Labels: Warning
 Lead Shielding: New
 Meters: Digital Survey
 Meters: Radiation Survey
 Meters: Survey, Geiger-Mueller
 Monitors: Area Radiation
 Monitors: Portal
 Monitors: Radiation
 Planchets
 Probes: Geiger-Mueller, End Window
 Probes: Geiger-Mueller, Pancake
 Ratemeters: Alarming
 Refrigerators: Lead-Lined
 Rope: Warning
 Safes/Vaults: Lead Shielded
 Shielding
 Shielding Materials: Lead Glass
 Shielding: Custom
 Shielding: Lead
 Shielding: Lead Bricks
 Shielding: Portable
 Shielding: Radiation
 Shields: Bench-Top
 Shields: Mobile
 Shields: Mobile Lead
 Signs: Warning
 Waste Storage



• **Climax Portable Machine Tools, Inc.,**
 2712 E. 2nd St., Newberg, OR 97132; Phone: 800-333-8311, Fax: 856-374-0767, Http://www.cpmt.com, Email: info@cpmt.com, Contact: Steve Muhr.
(See advertisement on page 57)

Boring: Metal
 Consulting: Maintenance
 Consulting: Maintenance Programs
 Consulting: Preventive Maintenance
 Engineering: Maintenance
 Hydraulic Equipment
 Lapping Machines
 Lathes: Transportable
 Machine Shop: Portable
 Machines: Grinding
 Machines: Milling
 Machining
 Machining Centers: Field
 Machining: Coupling
 Machining: Flanges
 Machining: Generators
 Machining: Heat Exchanger
 Machining: Journals
 Machining: Nozzle
 Machining: Onsite
 Machining: Seals
 Machining: Stud Removal
 Machining: Turbine
 Machining: Valve
 Maintenance: Valves
 Tools: Maintenance
 Tools: Pipe Bevelling
 Training: Maintenance
 Training: Nuclear Equipment Maintenance
 Turbine Blades: Weld Repairs
 Turbine Generator Maintenance
 Turbine Maintenance
 Valve Reconditioning
 Valve Refurbishment
 Valve Repair
 Valve Repair Equipment
 Valve Services
 Valve Test Benches
 Valve Testing
 Valve Testing Systems
 Valves: Main Steam Isolation, Maintenance
 Weld Repair
 Welding
 Welding Equipment
 Welding: Automated
 Welding: Valve

Container Products Corporation,
 112 N. College Rd., P.O. Box 3767, Wilmington, NC 28405; Phone: 910/392-6100, Fax: 910/392-6778, Http://www.c-p-c.com, Email: hjksales@c-p-c.com, Contact: H. Jeffrey Kahle.

Compactors
 Containers: Radwaste
 Containers: Shielded
 Containers: Steel
 Containers: Storage
 Containers: Transport
 Containers: Waste
 Decontamination Equipment
 Glove Boxes
 Metal Fabrication
 Metal Fabrication: Aluminum
 Metal Fabrication: Stainless Steel
 Metal Fabrication: Steel

Radwaste Compaction Equipment
 Radwaste Compaction: Supercompactor
 Radwaste Equipment: Low-Level
 Radwaste Packaging
 Radwaste Volume Reduction
 Shields: Lead Frisker



• **Copes-Vulcan, An SPX Brand,**
 5620 West Road, McKean, PA 16426; Phone: (814) 476-5800, Fax: (814) 476-5848, Http://www.copes-vulcan.com, Email: cv@spx.com, Contact: Courtney Butzine.
(See advertisement on page 87)

Actuators
 ASME Certificate Holder
 Consulting: Valve Actuators
 Consulting: Valves
 Valve Actuator
 Valve Actuators: Pneumatic
 Valve Analysis
 Valve Assemblies
 Valve Modification
 Valve Parts
 Valve Positioners
 Valve Reconditioning
 Valve Refurbishment
 Valve Repair
 Valve Services
 Valves
 Valves: Ball
 Valves: Butterfly
 Valves: Check
 Valves: Control
 Valves: Custom
 Valves: Diaphragm
 Valves: Explosive Actuated
 Valves: Flanged
 Valves: Gate
 Valves: Globe
 Valves: High-Pressure
 Valves: Isolation
 Valves: Motor Operated
 Valves: Plug
 Valves: Safety-Related
 Valves: Sampling
 Valves: Steam Conditioning

CS-2 Inc.,
 P.O. Box 553, Grand Island, NY 14072; Phone: (866) 699-5515, Fax: (716) 773-5515, Http://www.cscs-i.com, Email: CS2@cscs-icom, Contact: Bill Schaab.

Consulting: Decommissioning
 Environmental Management
 Health & Safety Services
 Project Management
 Remediation Services

CTR Technical Services, Inc.,
 950 Sugarloaf Rd., Manitou Springs, CO 80829; Phone: (800) 524-9328, Fax: (719) 685-3579, Http://www.ctr-tech.com, Email: ctr@ctr-tech.com, Contact: Charles T. Rombough.

Analysis: Criticality
 Analysis: Engineering
 Analysis: Reactor Physics
 Analysis: Safety
 Consulting: Design Basis Documentation
 Consulting: Design Reports
 Consulting: Engineering
 Consulting: Nuclear
 Consulting: Reactor Engineering
 Licensing Support Services
 Licensing: Technical Specifications
 Nuclear Fuel Cycle: Engineering
 Nuclear: Shielding

R&D Services
 R&D: Instrumentation/Control Systems
 R&D: Reactor
 R&D: Reactor Safety
 R&D: Reactors
 Reactor Core Design
 Reactors: Engineering
 Safety Analysis
 Software Validation
 Software Verification
 Software: Custom
 Staff Support: Engineering
 Staff Support: Technical
 Training: Nuclear Safety

• **Data Systems & Solutions SAS,**

23 Chemin Du Vieux Chene 38246, Meylan Cedex
 9, F38240 France; Phone: (33) (0) 4-76-61-15-00,
[Http://www.ds-s.com](http://www.ds-s.com), Email: desgeorger@DS-S.com,
 Contact: Romain Desgeorge.
(See advertisement on page 15)

Aging Management
 Alarm Monitoring Panels
 Alarm Monitoring System
 Alarm System Sensors
 Alarm Systems
 Alarms: Electronic Modules
 Alarms: Safety-Related
 Amplifiers
 Analysis: Criticality
 Analysis: Reactor Physics
 Analysis: Reliability
 Analysis: Safety
 Assemblies: Electrical
 Assemblies: Printed Circuit
 Availability Improvements
 Borescopes: Measurement Systems
 Bus: 1E Nonsegregated Phase
 Bus: Nonsegregated Phase
 Cable Assemblies: Cont Rod Position Indicator
 Cable: Instrumentation
 Cable: Mineral Insulated
 Cable: Radiation Resistant
 Cable: Safety-Related
 Cable: Signal
 Cable: Switchboard
 Chambers: Fission
 Chambers: Gamma Ion
 Chambers: Ion
 Chambers: Ionization
 Chambers: Moveable In-Core Fission
 Chambers: Reactor Control
 Circuit Breaker Maintenance
 Circuit Breaker Retrofitting
 Circuit Breakers: Low-Voltage Air, Safety-Related
 Circuit Breakers: Safety-Related
 Computers: Upgrades
 Control Panel Design
 Control Panels: 1E
 Control Panels: Safety-Related
 Control Rod Control System Maintenance
 Control Rod Control Systems
 Control Rod Drive Maintenance
 Control Rod Position Indicators
 Control Rods
 Control Room Consoles: Class 1E
 Control Systems
 Control Systems: Automated
 Control Systems: Class 1E
 Control Systems: Computer-Assisted
 Control Systems: Distributive
 Control Systems: Safety
 Control Systems: Supervisory
 Controllers: Analog
 Converters
 Converters: Safety-Related
 Counters: BF3
 Counters: Fission
 Counters: Gamma
 Counters: Neutron REM
 Counters: Neutron, He-3 Proportional
 Counters: Radiation
 Design Review
 Design Services
 Design: Control Panel
 Design: Electrical
 Design: Mechanical

Design: Process
 Design: Seismic
 Detectors: BF3
 Detectors: Gamma
 Detectors: Neutron
 Detectors: Radiation
 Engineering: Instrumentation
 Engineering: Maintenance
 Equipment: Safety-Related
 Instrumentation
 Instrumentation Cabinets
 Instrumentation/Control System Calibration
 Instrumentation/Control System Maintenance
 Instrumentation/Control Systems
 Instrumentation/Control Systems: Class 1E
 Instrumentation/Control Systems: Repair
 Instrumentation/Control: Part Replacement
 Instrumentation: Electrical Troubleshooting
 Instrumentation: Nuclear
 Instrumentation: Process Control
 Instrumentation: Specialized
 Instruments: Safety-Related
 Logic System: Class 1E
 Maintenance
 Maintenance Management Systems
 Maintenance Program Evaluation
 Maintenance Services
 Maintenance Services: Offsite
 Maintenance: Electronics
 Maintenance: Equipment
 Maintenance: Predictive
 Maintenance: Preventive
 Maintenance: Reliability Centered
 Monitoring Systems: Neutron
 Monitoring Systems: Neutron Flux
 Monitoring Systems: Plant Safety
 Monitoring Systems: Reactor Vessel Level
 Monitoring: Neutron
 Monitors: Intermediate Range
 Power Supplies: High-Voltage
 Power Supplies: Safety-Related
 Power Systems: Photovoltaic
 Preamplifiers: Instrumentation
 Predictive Maintenance Systems: Electrical
 Process Control Systems
 Process Instrumentation Maintenance
 Process Protection Systems
 R&D: Instrumentation/Control Systems
 Ratemeters: Alarming
 Reactor Control Systems
 Reactor Protection Systems
 Relay Systems
 Relays: Safety-Related
 Reliability Database Services
 Rod Control Maintenance Services
 Safeguard Equipment
 Safety Analysis
 Software
 Software Conversion
 Software Development
 Software Validation
 Software Verification
 Training: Instrumentation/Control
 Training: Maintenance
 Uninterruptible Power Supplies
 Uninterruptible Power Supplies: Service
 Uninterruptible Power Supply: Safety-Related

Diversified Technologies Services, Inc.,

2680 Westcott Boulevard, Knoxville, TN 37931;
 Phone: (865) 539-9000, Fax: (865) 539-9001, [Http://www.dts9000.com](http://www.dts9000.com), Email: info@dts9000.com, Contact: Charles Jensen.

Boric Acid Recovery
 Demineralization
 Dewatering & Drying
 Filtration
 Polymer Solidification Services
 Reverse Osmosis
 Silica Removal
 Sludge Filtration & Drying
 UltraFiltration
 Underwater Systems
 Volume Reduction
 Waste Solidification

• **DIVESCO, Inc.,**

5000 Hwy. 80 E, Jackson, MS 39208; Phone: (601) 932-1934, Fax: (601) 932-5698, [Http://www.divesco.com](http://www.divesco.com), Email: kay@divesco.com, Contact: S.Kay Fisher.
(See advertisement on page 64)

Electronic Components and Equipment
 Equipment: Mechanical
 Expediting Services
 Instrumentation/Control Systems
 Instrumentation/Control: Part Replacement
 Inventory Management
 Motors: Electric
 Parts: BWR Spare
 Parts: Procurement Assistance
 Parts: Replacement
 Parts: Spare
 Pumps
 Recovery: Asset
 Valves
 Valves: Butterfly
 Valves: Check
 Valves: Control
 Valves: Diaphragm
 Valves: Gate
 Valves: Globe
 Valves: Plug
 Valves: Relief
 Valves: Solenoid

E.H. Wachs Co.,

600 Knightsbridge Pkwy., Lincolnshire, IL 60069;
 Phone: 800-323-8185, Fax: 847-520-1147, [Http://www.wachsco.com](http://www.wachsco.com), Email: sgilmore@wachsco.com, Contact: Sherry Gilmore.

Actuators
 Bits: Pipe Beveling Tool
 Bits: Pipe Cutting Tool
 Construction Products
 Cutting Equipment: Underwater
 Decommissioning Equipment
 Decommissioning Services
 Diagnostics: Valve
 Drills
 Engineering: Design
 Equipment Design
 Hydraulic Equipment
 Lathes: Transportable
 Machines: Milling
 Machining: Flanges
 Machining: Onsite
 Maintenance: Equipment
 Outage Equipment
 Pipe Beveling Machinery
 Pipe Beveling Tools: Rental
 Pipe Cutting Machinery
 Pipe Cutting Tools: Rental
 Pipe End Finishing Machine
 Refacing Equipment: Flanges
 Rental: Equipment
 Repair Equipment: Remote-Controlled
 Repair: General Equipment
 Saws
 Steam Generator Maintenance Equipment
 Stud Removal
 Tooling: Underwater
 Tools: Fabrication
 Tools: Hydraulic
 Tools: Maintenance
 Tools: Pipe Beveling
 Tools: Pipe Cutting
 Tools: Tubing Cutting
 Tools: Tubing, End Squaring
 Tools: Tubing: Squaring
 Tube Cutting Machinery
 Tube End Finishing Machine
 Vacuum Equipment
 Vacuum Systems
 Valve Actuator
 Valve Actuators: Electric
 Valve Actuators: Hydraulic
 Valve Actuators: Pneumatic
 Valve Diagnostic Systems
 Valve Exercising
 Valve Repair Equipment
 Valve Turning

Enercon Services, Inc.,

500 Town Park Lane, Kennesaw, GA 30144; Phone: (770) 919-1930, Fax: (770) 919-1932, Http://www.enercon.com, Email: awoods@enercon.com, Contact: Arther Woods.

Aging Management
 Analysis: Engineering
 Analysis: Environmental
 Analysis: Finite Element
 Analysis: Heat Transfer
 Analysis: Hydraulic
 Analysis: Project
 Analysis: Reliability
 Analysis: Risk
 Analysis: Root Cause
 Analysis: Safety
 Analysis: Severe Accident
 Analysis: Stress
 Analysis: Structural
 Analysis: Support
 Analysis: Task
 Analysis: Thermal
 Analysis: Vibration
 Analytical Services
 Barriers: Security
 Boric Acid Recovery
 Calibration Services
 Cameras: Closed-Circuit Television
 Commercial-Grade Dedication
 Communications Systems: Emergency
 Consulting: Appendix R
 Consulting: Balance-of-Plant
 Consulting: Clean Air
 Consulting: Computer-Aided Engineering
 Consulting: Configuration Management
 Consulting: Control Systems
 Consulting: Data Acquisition Systems
 Consulting: Decommissioning
 Consulting: Decontamination
 Consulting: Design & Documentation
 Consulting: Design Assessment
 Consulting: Design Basis Documentation
 Consulting: Design Reports
 Consulting: Digital Systems
 Consulting: Economic Analysis
 Consulting: Effluents Management
 Consulting: Electrical
 Consulting: Emergency Preparedness
 Consulting: Engineering Mechanics
 Consulting: Engineering: BWR
 Consulting: Environmental
 Consulting: Environmental Analysis
 Consulting: Environmental Management
 Consulting: Erosion/Corrosion Program
 Consulting: Erosion/Corrosion Programs
 Consulting: Fire Protection
 Consulting: Fluid Dynamic Analysis
 Consulting: Fluid Flow
 Consulting: FSAR Licensing Review
 Consulting: Hazardous Materials Management
 Consulting: Hazardous Waste Management
 Consulting: Health Physics
 Consulting: Heat Transfer
 Consulting: Human Factors Engineering
 Consulting: HVAC Systems
 Consulting: Hydraulic
 Consulting: In-Service Inspection Programs
 Consulting: License Renewal
 Consulting: Licensee Event Reports
 Consulting: Licensing
 Consulting: Litigation Support
 Consulting: LOCA Analysis
 Consulting: Management Effectiveness Reviews
 Consulting: Modifications
 Consulting: Nuclear
 Consulting: Operations
 Consulting: Piping
 Consulting: Program Assessment
 Consulting: Pumps
 Consulting: Radiation Monitoring
 Consulting: Records Management Systems
 Consulting: Regulatory Compliance

Consulting: Risk Analysis
 Consulting: Root Cause Analysis
 Consulting: Security
 Consulting: Self-Assessment
 Consulting: Setpoint Analyses
 Consulting: Siting
 Consulting: Structural
 Consulting: System Design
 Consulting: System Safety
 Consulting: Thermal-Hydraulics
 Consulting: Ventilation System
 Consulting: Waste Management
 Decommissioning Services
 Decontamination
 Design Basis Reconstitution
 Design Services
 Design: Computer-Aided
 Design: Electrical
 Design: Mechanical
 Design: Process
 Design: Seismic
 Design: Structural
 Engineering Services: BWR
 Engineering Services: PWR
 Engineering: Civil
 Engineering: Design
 Engineering: Electrical
 Engineering: Instrumentation
 Engineering: Mechanical
 Engineering: Power Uprate
 Environmental Impact Assessment
 Environmental Qualification
 Equipment Qualification
 Modeling: Plant Systems
 Models: Thermal Hydraulic System
 Operation Procedure Upgrades
 Procedure Development
 Remediation Services
 Remediation: Groundwater
 Safeguards
 Security System Design
 Security System Integrators
 Security System Upgrades
 Site Surveys
 Storage: Spent Fuel
 Waste Characterization
 Waste Processing

Energy & Process Corporation,

2146-B Flintstone Dr., P.O. Box 125, Tucker, GA 30084; Phone: (770) 934-3101, Fax: (770) 938-8903, Http://www.energyandprocess.com, Email: mark.capallo@energyandprocess.com, Contact: Mark Capallo.

ASME Certificate Holder
 Bolts
 Castings
 Cladding
 Fabrication: Tubular Products
 Fabrication: Tubular Products
 Fabrications
 Flanges
 Forgings
 Machining
 Metal Fabrication
 Parts: Procurement Assistance
 Pipe
 Pipe Assemblies
 Pipe Fittings
 Pipe Fittings
 Pipe: High-Alloy Steel
 Pipe: Stainless Steel
 Steel Components
 Steel: Carbon
 Steel: Stainless
 Strainers: Liquid
 Studs
 Testing: Safety-Related Components
 Tubing
 Welding: ASME Code



Engine Systems, Inc.,

175 Freight Road, Rocky Mount, NC 27804; Phone: (252) 977-2720, Fax: (252) 446-3830, Http://www.enginesys.com/, Email: michael.thiel@kirbycorp.com, Contact: Michael Thiel.

Control Panels: Safety-Related
 Data Recorders: Seismic Qualified
 Diesel Engine Maintenance
 Diesel Engines: Overhauling
 Diesel Generator Engineering Studies
 Diesel Generators
 Diesel Generators: Parts
 Diesel Generators: Repair, Safety-Related
 Diesel Generators: Safety-Related
 Environmental Qualification
 Materials Testing Equipment
 Meters: Safety-Related
 Recorders: Panel Mounted
 Seismic Qualification
 Testing: Safety-Related Components
 Training: Diesel Generators
 Transformers: Safety-Related



Excelsior College,

7 Columbia Circle, Albany, NY 12182; Phone: (518) 464-8665, Fax: (518) 464-8777, Http://www.excelsior.edu, Email: atraver@excelsior.edu, Contact: Adam Traver.

Colleges: Nuclear Technology Degrees
 Degrees: Nuclear Technology
 Education: Nuclear Technology Degrees
 Training: INPO
 Training: Management

EXPONENT,

149 Commonwealth Dr., Menlo Park, CA 94025; Phone: (888) 656-3976 (EXPO), Fax: (650) 688-7231, Http://www.exponent.com, Email: info@exponent.com, Contact: Joseph Famigletti.

Analysis: Chemical
 Analysis: Dynamic
 Analysis: Engineering
 Analysis: Environmental
 Analysis: Finite Element
 Analysis: Heat Transfer
 Analysis: Hydraulic
 Analysis: Material Identification
 Analysis: Polymer
 Analysis: Reliability
 Analysis: Risk
 Analysis: Root Cause

Analysis: Static
 Analysis: Stress
 Analysis: Structural
 Analysis: Thermal
 Analysis: Vibration
 Assessments: Program
 Check Valve Application Review
 Claim Analysis
 Claim Resolution
 Cleaning: Heat Exchanger Tube
 Coatings Testing
 Configuration Management
 Consulting
 Consulting: Business Management
 Consulting: Chemistry
 Consulting: Configuration Management
 Consulting: Construction
 Consulting: Control Systems
 Consulting: Cooling Systems
 Consulting: Design Assessment
 Consulting: Design Basis Documentation
 Consulting: Design Reports
 Consulting: Effluents Management
 Consulting: Electrical
 Consulting: Engineering Mechanics
 Consulting: Environmental
 Consulting: Environmental Analysis
 Consulting: Environmental Management
 Consulting: Erosion/Corrosion Program
 Consulting: Fire Protection
 Consulting: Fluid Dynamic Analysis
 Consulting: Fluid Flow
 Consulting: Fracture Mechanics
 Consulting: FSAR Licensing Review
 Consulting: Hazardous Materials Management
 Consulting: Hazardous Waste Management
 Consulting: Health
 Consulting: Heat Transfer
 Consulting: Human Factors Engineering
 Consulting: Hydraulic
 Consulting: License Renewal
 Consulting: Licensing
 Consulting: Life Cycle Management
 Consulting: Literature Searches
 Consulting: Litigation Support
 Consulting: Maintenance
 Consulting: Maintenance Programs
 Consulting: Management
 Consulting: Management Effectiveness Reviews
 Consulting: Material Management
 Consulting: Materials Analysis
 Consulting: Materials Engineering
 Consulting: Metallurgical Analysis
 Consulting: Motors
 Consulting: Organization Effectiveness
 Consulting: Organizational Development
 Consulting: Pipe Support
 Consulting: Piping
 Consulting: Plant Life Extension
 Consulting: Preventive Maintenance
 Consulting: Problem Solving
 Consulting: Process Safety
 Consulting: Procurement Support
 Consulting: Productivity Improvement
 Consulting: Project Management
 Consulting: Prudence Studies
 Consulting: Pumps
 Consulting: Regulatory Compliance
 Consulting: Reliability Analysis
 Consulting: Remotely Operated Vehicles
 Consulting: Residual Life Assessment
 Consulting: Risk Analysis
 Consulting: Risk Management
 Consulting: Robotics
 Consulting: Root Cause Analysis
 Consulting: Seismic
 Consulting: Strategic Planning
 Consulting: Stress, Material
 Consulting: Structural
 Consulting: System Safety
 Consulting: Technical Assessments
 Consulting: Thermal Analysis
 Consulting: Thermal-Hydraulics
 Consulting: Third Party Review
 Consulting: Valve Actuators
 Consulting: Valves
 Consulting: Water Treatment

Containment Analysis
 Design Review
 Engineering Services
 Engineering: Civil
 Engineering: Electrical
 Engineering: Environmental
 Engineering: Materials
 Engineering: Mechanical
 Engineering: Metallurgical
 Environmental Impact Assessment
 Environmental Management
 Environmental Services
 Failure Analysis
 Failure Analysis: Electron Microscopy
 Fire Protection
 Industrial Hygiene Services
 Industrial Hygiene: Program Evaluation
 Inspection
 Inspection Services
 Investigations: Accident
 Investigations: Event
 Investigations: Incident
 Lab Research: Materials
 Laboratory Services
 Licensing Support Services
 Life Extension
 Maintenance Program Evaluation
 Maintenance: Reliability Centered
 Maintenance: Valves
 Materials Characterization
 Materials Services: BWR
 Materials Testing Equipment
 Piping Analysis
 Pressure Vessel Analysis
 Probabilistic Risk Assessment
 Probabilistic Safety Analysis
 Procedure Development: Root Cause
 Regulatory Compliance
 Review Support: Operational Readiness
 Risk Assessment
 Safety Assessment
 Safety Evaluations: Preparation
 Safety Evaluations: Program Reviews
 Seismic Analysis
 Seismic Qualification
 Simulation Services
 Site Surveys
 Testing: Chemical
 Testing: Electrical
 Testing: Electrochemical
 Testing: Laboratory
 Testing: Mechanical
 Testing: Metallurgical
 Valve Analysis
 Valve Testing
 Water Management

Flowserve Flow Control Division,
 1900 South Saunders Street, Raleigh, NC 27603;
 Phone: (919) 831-3200, Fax: (919) 831-3317, Http://
www.flowserve.com, Email: fbensinger@flowserve.com, Contact: Floyd Bensinger.

Actuators
 Field Service
 Maintenance: Valves
 Valve Actuator
 Valve Actuator Parts
 Valve Actuator Repair
 Valve Actuators: Electric
 Valve Actuators: Hydraulic
 Valve Parts
 Valve Repair
 Valve Services
 Valves
 Valves: Ball
 Valves: Bellows Sealed
 Valves: Butterfly
 Valves: Check
 Valves: Control
 Valves: Gate
 Valves: Globe
 Valves: High-Pressure
 Valves: Isolation
 Valves: Main Steam Isolation, Maintenance
 Valves: Motor Operated
 Valves: Safety-Related

Fuel Tank Maintenance Company LLC,
 240 Mill Dr, Cookeville, TN 38501; Phone: (931)
 528-1137, Fax: (931) 520-3862, Http://www.fuel-tankmaintenance.com, Email: jthahnjr@hotmail.com,
 Contact: Jerry T. Hahn.

Asbestos Abatement Services
 Coating Application Services
 Decontamination Services
 Environmental Remediation
 Lead Paint Abatement Equipment
 Liners
 Pipe Cleaning Service
 Turbine Blades: Coating Services
 UltraFiltration



HITACHI

- **GE Hitachi Nuclear Energy,**
 3901 Castle Hayne Rd., PO Box 780 M/C J32, Wilm-
 ington, NC 28402; Phone: (910) 675-6689, Http://
www.ge-energy.com/nuclear, Email: Christa.Miller@ge.com, Contact: Christa G Miller.
(See advertisement on page 9)

Consulting: Plant Performance Improvement
 Containers: Transport
 Control Rod Blades: BWR
 Control Rods
 Engineering Services: BWR
 Field Service
 Fuel Analysis
 Fuel Examination
 Fuel: BWR
 Hot Cell Services
 Inspection
 Instrumentation: Nuclear
 Monitoring: Equipment, BWR
 Parts: O.E.M.
 Post Irradiation Examination
 Project Management
 Radiography: Neutron
 Reactor Core Components
 Reactor Internals Modification
 Reactor Services
 Reactors: Advanced Systems, BWR
 Reactors: BWR: Equipment Upgrades
 Software: Fuel Management
 Strainers: Suppression Pool ECCS
 Tools: Inspection
 Tools: Robotic
 Welding



- **General Atomics Electronic Systems, Inc.,**
 4949 Greencraig Ln., San Diego, CA 92123; Phone:
 (858) 522-8352, Fax: (858) 522-8318, Http://www.ga-esi.com, Email: phil.newman@ga-esi.com, Contact:
 Phil Newman.
(See advertisement on page 37)

Calibration: Radiation Monitoring Systems
 Calibrators: Radioisotope Dose
 Detectors: Gamma
 Detectors: Gas
 Detectors: Gas, Area
 Detectors: Geiger-Muller
 Detectors: Radiation
 Detectors: Scintillation
 Dosimeter Readers: Automatic Pocket
 Dosimeters: Alarm
 Dosimeters: Electronic Pocket
 Dosimeters: Electronic, Digital
 Dosimeters: Personal
 Dosimeters: Radiation

Instrumentation: Monitoring Environmental
 Instrumentation: Nuclear
 Monitoring Systems
 Monitoring Systems: Airborne Radioactivity
 Monitoring Systems: Gas
 Monitoring: Air
 Monitoring: Environmental Radiological
 Monitoring: Radiation
 Monitoring: Water
 Monitors: Air
 Monitors: Alpha
 Monitors: Area
 Monitors: Area Radiation
 Monitors: Beta
 Monitors: Dose Rate
 Monitors: Gamma
 Monitors: Gas
 Monitors: Gas, Containment
 Monitors: Gas, Post-Accident
 Monitors: Iodine Air
 Monitors: Liquid
 Monitors: Noble Gas
 Monitors: Particulate
 Monitors: Process Radiation
 Monitors: Radiation
 Monitors: Radioactive Waste Storage
 Monitors: Stack Radiation
 Radiation Detection/Monitoring Systems
 Radiation Vehicle Monitoring Systems
 Sources: Radioactive
 Training: Radiation Monitoring Systems

General Cable (Brand-Rex),
 1600 W. Main St., Willimantic, CT 06226-1128;
 Phone: (860) 465-8712, Fax: (860) 465-8869, Http://
 www.GeneralCable.com, Email: gliskom@General-
 Cable.com, Contact: Gerald R. Liskom.

Cable: Coaxial
 Cable: Control
 Cable: Fiber Optic
 Cable: Flame Resistant
 Cable: Instrumentation
 Cable: Radiation Resistant
 Cable: Safety-Related
 Cable: Switchboard
 Cable: Thermocouple

Herguth Laboratories,
 101 Corporate Pl., Vallejo, CA 94590; Phone: (800)
 645-5227, Fax: (707) 554-0109, Http://www.herguth.
 com, Email: lperry@herguth.com, Contact: Linda
 Perry.

Analysis: Chemical
 Analysis: Root Cause
 Chemistry Services
 Consulting: Maintenance
 Consulting: Maintenance Programs
 Failure Analysis
 Failure Analysis: Electron Microscopy
 Grease Analysis
 Lab Analysis: Radiological
 Laboratory Services
 Lubrication Analysis
 Maintenance: Predictive
 Maintenance: Preventive
 Monitoring Technologies: Condition
 Oil Analysis
 Oil Analysis Equipment
 R&D Services
 R&D: Chemistry
 Testing: Chemical
 Testing: Laboratory
 Testing: Special

• **HI-Q Environmental Products Company,**
 7386 Trade St., San Diego, CA 92121; Phone: (858)
 549-2820, Fax: (858) 549-9657, Http://www.HI-Q.
 net, Email: info@HI-Q.net, Contact: Marc Held.
(See advertisement on page 10)

Air Samplers
 Pumps: Air Sampling

IHI Southwest Technologies, Inc.,
 6766 Culebra Rd., San Antonio, TX 78238; Phone:
 (210) 256-4107, Fax: (210) 521-2311, Http://www.
 ihiswt.com, Email: stodd@ihiswt.com, Contact: Steve
 Todd.

Heat Exchanger Analysis/Inspection Services
 Inspection Services
 Inspection: In-Service
 Inspection: Pressure Vessel
 Inspection: Vessel Welds, BWR
 NDE Services
 Nondestructive Testing Services
 Training: Nondestructive Testing
 Ultrasonic Testing Services

ILD, Inc.,
 8867 Highland Rd., #378, Baton Rouge, LA 70808;
 Phone: (225) 769-2780, Fax: (225) 769-2751, Http://
 www.ildpower.com, Email: jack@ildpower.com,
 Contact: Jack Little.

Condenser Leak Detection
 Consulting: Balance-of-Plant
 Consulting: Modifications
 Engineering Services: BWR
 Engineering Services: PWR
 Engineering: Design
 Engineering: Power Upgrade
 Engineering: Systems
 Staff Support: Engineering
 Testing: Special



KINECTRICS

• **Kinectrics Incorporated,**
 800 Kipling Avenue, Toronto, Ontario, M8Z 6C4
 Canada; Phone: (416) 207-6000, Fax: (416) 207-6532,
 Http://www.kinectrics.com, Email: cheryl.tasker-
 shaw@kinectrics.com, Contact: Cheryl Tasker-Shaw.
(See advertisement on page 51)

Analysis: Chemical
 Analysis: Material Identification
 Analysis: Mixed Waste
 Analysis: Polymer
 Analysis: Radioactive Gas
 Analysis: Root Cause
 Analytical Services
 Circuit Breakers: Molded Case, Safety-Related
 Cleaning: Chemical Processes
 Clothing: Protective, Fabrics
 Coatings
 Coatings Testing
 Concrete Repair Materials
 Consulting: Chemical Cleaning
 Consulting: Electrical
 Consulting: Environmental
 Consulting: Hazardous Waste Management

Consulting: Management Effectiveness Reviews
 Consulting: Radiochemistry
 Consulting: Radwaste
 Consulting: Root Cause Analysis
 Containers: Radwaste
 Control Panels: Safety-Related
 Control Systems: Class 1E
 Converters: Safety-Related
 Corrosion Testing Laboratory
 Decontamination Processes
 Decontamination Services
 Engineering Services
 Engineering Services: PWR
 Environmental Qualification
 Equipment Qualification
 Equipment Qualification: Components, ASME
 Failure Analysis
 Failure Analysis: Electron Microscopy
 Fuel Channels
 Fuse Holders: Safety-Related
 Fuses: Safety-Related
 Inspection Equipment: Development
 Inspection: Steam Generator
 Instrumentation/Control Systems: Class 1E
 Investigations: Accident
 Ion Exchange Resins
 Lab Analysis: Environmental
 Lab Analysis: Radiological
 Lab Research: Materials
 Motor Control Centers: Safety-Related Parts
 Panels: Power Distribution, Safety-Related
 Panels: Safety-Related
 Parts Evaluation
 Parts: Procurement Assistance
 Procurement
 Project Management
 Qualification: Supplier
 R&D Services
 R&D: Materials Performance
 R&D: Radwaste Treatment
 Radwaste
 Radwaste Analysis
 Seismic Analysis/Testing Equipment
 Terminal Blocks: Safety-Related
 Testing: Chemical
 Testing: Electrical
 Testing: Laboratory
 Testing: Mechanical
 Tools: Fabrication
 Tools: Inspection
 Ultrasonic Inspection System Development

Laboratory Services,
 135 W. Trail St., Jackson, MI 49201; Phone: (800)
 736-4147, Fax: (517) 788-1104, Http://www.labora-
 toryservices.com, Email: naserafin@cmsenergy.com,
 Contact: Nick Serafin.

Analysis: Material Identification
 Calibration Services
 Eddy Current Testing Services
 Failure Analysis
 Failure Analysis: Electron Microscopy
 Laboratory Services
 Microscopy: Scanning Electron
 NDE Services
 NDE: Section XI Support
 Nondestructive Testing & Evaluation
 Spectroscopy: X-Ray Photoelectron
 Staff Support
 Testing: Acoustic Emission
 Testing: Chemical
 Testing: Laboratory
 Testing: Metallurgical
 Testing: Special

Lights, Camera, Action LLC,
 806 W. Impala Circle, Mesa, AZ 85210-5996; Phone:
 (480) 345-0642, Fax: (480) 345-0644, Http://www.
 lights-camera-action.net, Email: sales@lights-camera-
 action.net, Contact: Walt Ahland.

Camera Systems: Miniature
 Camera Tubes: Radiation Hardened Television
 Cameras: Inspection
 Cameras: Underwater
 Lights: Underwater

- **LND, Inc.,**
3230 Lawson Blvd., Oceanside, NY 11572; Phone:
(516) 678-6141, Fax: (516) 678-6704, [Http://www.lndinc.com](http://www.lndinc.com), Email: info@lndinc.com, Contact: William Lehnert.
(See advertisement on page 61)

Chambers: Fission
Chambers: Ionization
Counters: Alpha/Beta
Counters: BF3
Counters: Gamma
Counters: Neutron, He-3 Proportional
Counters: Radiation
Detectors: Air Ionization Chamber
Detectors: BF3
Detectors: Gamma
Detectors: Geiger-Mueller
Detectors: Neutron
Detectors: Radiation
Detectors: Radiation, Gas-Filled
Monitoring: Radiation
Monitors: Alpha
Monitors: Area
Monitors: Area Radiation
Monitors: Gamma
Monitors: Gas
Monitors: Gas, Post-Accident
Probes: Gamma
Probes: Geiger-Mueller
Probes: Geiger-Mueller, End Window
Probes: Geiger-Mueller, Pancake
Probes: Geiger-Mueller, Side Window
Radiation Detection/Monitoring Systems
X-Ray Diffraction Equipment
X-Ray Fluorescence Equipment

MEGGITT

Meggitt Safety Systems

- **Meggitt Safety Systems,**
1915 Voyager Avenue, Simi Valley, CA 93063; Phone:
805-584-4100X8154, Fax: 805-584-9157, [Http://www.meggittsafety.com](http://www.meggittsafety.com), Email: alex.luterstein@meggitt.com, Contact: Alex M. Luterstein.
(See advertisement on page 20)

Air Monitoring Systems: Containment
Bulkhead Penetrations: IE Qualified
Cable Systems: Appendix R
Circular Multipin Connectors: IE Qualified
I&C Cable Systems: IE Qualified



- **Mirion Technologies,**
Bishop Ranch 8, 3000 Executive Parkway Suite 220,
San Ramon, CA 94583; Phone: (925) 543-0800,
[Http://www.mirion.com](http://www.mirion.com), Email: info@mirion.com,
Contact: Kimberly Croxson.
(See advertisement on page 17)

Access Control Systems
Air Samplers
Air Sampling Systems
Alarm Monitoring System
Alarms: Dose
Alarms: Rate
Alarms: Safety-Related
Analysis: Neutron Activity
Analyzers: Multichannel
Cable Assemblies
Cable Assemblies: Cont Rod Position Indicator

Cable Assemblies: Control Rod Drive Mechanism
Cable Assemblies: Core Monitoring
Cable Assemblies: Electronic
Cable Assemblies: Fiber Optic
Cable Assemblies: Radiation Resistant
Cable Assemblies: Thermocouple
Cable: Coaxial
Cable: Flame Resistant
Cable: High-Temperature
Cable: Instrumentation
Cable: Mineral Insulated
Cable: Radiation Resistant
Cable: Safety-Related
Cable: Signal
Cable: Thermocouple
Calibration Services
Calibration: Radiation Monitoring Systems
Calibrators: Dosimeter
Calibrators: Instrument
Camera Systems: Miniature
Camera Tubes: Radiation Hardened Television
Cameras: Closed-Circuit Television
Cameras: High-Temperature
Cameras: Inspection
Cameras: Underwater
Chamber Detectors: Air Ionization
Chambers: Fission
Chambers: Gamma Ion
Chambers: Ion
Chambers: Ionization
Chambers: Moveable In-Core Fission
Chambers: Reactor Control
Connectors: Electrical
Connectors: Metal-to-Metal Clamp
Connectors: Quick Disconnect, Safety-Related
Consulting: Television Systems
Control Systems: Class 1E
Control Systems: Safety
Counters: BF3
Counters: Fission
Counters: Gamma
Counters: Radiation
Counting Systems: Proportional
Detector Refurbishment
Detectors: BF3
Detectors: Ex-Core
Detectors: Gamma
Detectors: Gas, Area
Detectors: In-Core
Detectors: Neutron
Detectors: Radiation
Detectors: Radiation, Gas-Filled
Dosimeters: Electronic Pocket
Dosimeters: Electronic, Digital
Dosimeters: Personal
Dosimetry Services: TLD Badges
Dosimetry Supplies: TLD
Dosimetry Systems
Feedthroughs: Fiber-Optic
Fibrescopes: Rad Hardened
Filters: Air Sampler
Image Recognition Systems
Inspection Equipment: Visual
Instrumentation
Instrumentation: Health Physics
Instrumentation: Nuclear
Instrumentation: Process Control
Instrumentation: Radiation Protection
Instruments
Instruments: Contamination Monitoring
Instruments: Portable Survey
Instruments: Safety-Related
Maintenance Support
Maintenance: Predictive
Maintenance: Preventive
Measurement Systems
Meters: Radiation Survey
Meters: Radon
Meters: Survey
Meters: Survey, Geiger-Mueller
Meters: Survey, Neutron
Monitoring Systems
Monitoring Systems: Airborne Radioactivity
Monitoring Systems: Neutron Flux
Monitoring Systems: Remote
Monitoring: Air

Monitoring: Equipment, BWR
Monitoring: Neutron
Monitoring: Radiation
Monitors: Air
Monitors: Alpha
Monitors: Area
Monitors: Area Radiation
Monitors: Beta
Monitors: Contamination
Monitors: Dose Rate
Monitors: Gamma
Monitors: Gas
Monitors: Gas, Post-Accident
Monitors: In-Core
Monitors: Intermediate Range
Monitors: Iodine
Monitors: Iodine Air
Monitors: Laundry Radioactivity
Monitors: Liquid
Monitors: Local Power Range
Monitors: Noble Gas
Monitors: Particulate
Monitors: Personnel Contamination
Monitors: Portal
Monitors: Portal Beta
Monitors: Portal Gamma
Monitors: Radiation
Monitors: Source Range
Monitors: Temperature
Outage Equipment
Penetrations: Containment
Penetrations: Electrical
Penetrations: Electrical, Adaptor Modules
Preamplifiers: Instrumentation
Probes: Gamma
Probes: Geiger-Mueller
Probes: Traversing In-Core Gamma
Probes: Traversing In-Core Neutron
Process Control Systems
Radiation Detection/Monitoring Systems
Radiation Vehicle Monitoring Systems
Radiological Surveys
Resistance Temp. Detector Modifications
Resistance Temperature Detectors
Seal Enclosures: Custom
Sealing: Penetration
Seals: Conduit
Sensors: Temperature
Software Development
Software: Health Physics
Software: Personnel Monitoring
Spectroscopy Systems: Alpha
Spectroscopy: Gamma
Spectroscopy: Neutron
Telemetry Systems
Television Systems: Closed-Circuit
Television Systems: Rad Hardened
Television Systems: Underwater, Rad Hardened
Thermocouple Attachment Units
Thermocouples
Thermocouples: In-Core
Thermocouples: In-Core, Replacement
Thermocouples: Safety-Related
Training: Computer-Based, Health Physics
Training: Dosimetry
Training: Radiation Monitoring Systems
Transducers: In-Line, High-Temperature
Transducers: In-Line, Low-Temperature
Transmitters: Radiation Monitors
Transmitters: Personnel Dosimetry
Valves: Emergency Service
Valves: Explosive Actuated
Valves: Safety-Related
Video Inspection Systems
Viewing Systems: Through-Wall

MOTA Corporation,
3410 Sunset Blvd., West Columbia, SC 29169; Phone:
(803) 794-1449, Fax: (803) 939-1083, [Http://www.motacorp.com](http://www.motacorp.com), Email: sgarner@motacorp.com,
Contact: Steve Garner.

Consulting: Decommissioning
Consulting: Decontamination
Consulting: Project Planning

Cutting Equipment: Underwater
Decommissioning Services
Decontamination
Decontamination Services
Planning Services
Project Management
Remediation
Remediation Services
Scheduling
Staff Support
Tools: Remote Handling

Mott Corporation,

84 Spring Ln., Farmington, CT 06032-3159; Phone: (860) 747-6333, Fax: (860) 747-6739, Http://www.mottcorp.com, Email: QUEST@mottcorp.com, Contact: Patty Dillon.

Filter Elements
Filter Media
Filters
Filters: Backwash
Filters: Condensate Polishing
Filters: Gas
Filters: Liquid
Filters: Porous Metal
Filters: Sintered Metal Fiber
Filtration
Filtration Equipment

Nuclear Shielding Supplies & Service, Inc.,

4620 S. Coach Dr., Tucson, AZ 85714-1942; Phone: (520) 917-0661 x22, Fax: (520) 917-0664, Http://www.nuclearshielding.com, Email: info@nuclearshielding.com, Contact: Jordy Ensio.

Blocks/Bricks: High-Density Concrete
Boron Carbide
Concrete Services
Shielding
Shielding Information: Nuclear
Shielding Materials
Shielding Materials: Gamma
Shielding Materials: Neutron
Shielding: Custom
Shielding: Gamma
Shielding: High-Density Concrete
Shielding: Neutron
Shielding: Portable
Shielding: Radiation
Shielding: X-Ray

• **NUCON International, Inc.,**

7000 Huntley Rd., Columbus, OH 43229; Phone: (614) 846-5710, X115, Fax: (614) 431-0858, Http://www.nucon-int.com, Email: curt.graves@nucon-int.com, Contact: Curtis Graves.
(See advertisement on page 49)

Adsorbents: Radioiodine
Adsorbents: Radioiodine, Laboratory Testing
Adsorber Cells: Charcoal
Adsorbents
Aerosol Testing Materials
Air Balancing
Air Filtration Units
Analysis: Radioactive Gas
ASME Certificate Holder
Calibration Services
Calibrators: Gamma Survey Instrument
Carbon: Activated
Charcoals: Radioiodine Laboratory Testing
Consulting
Consulting: Clean Air
Consulting: Filtration
Consulting: HEPA Systems
Consulting: HVAC Systems
Decontamination Equipment: Radioactive Gas
Filter Systems
Filter Systems: Portable HEPA
Filter Testing
Filters: Activated Carbon
Filters: Gas
Filtration Equipment
HVAC Systems: Acceptance Testing

HVAC Systems: AG-1 Testing
HVAC Systems: Start-Up Testing
HVAC Systems: Testing
Instruments: Aerosol Leak Detection
Instruments: Halide Leak Detection
Leak Detection Equipment
Pollution Control Systems
Standby Gas Treatment Systems
Systems: Gas Processing
Testing: Acceptance
Testing: Safety-Related Components
Tracer Gas Testing
Training: ANSI/ASME N510

O'Donnell Consulting Engineers, Inc.,

2940 South Park Rd., Bethel Park, PA 15102; Phone: (412) 835-5007, Fax: (412) 835-5017, Http://www.odonnellconsulting.com, Email: wo@odonnellconsulting.com, Contact: Bill O'Donnell.

Analysis: Root Cause
Analysis: Stress
Analysis: Structural
Analysis: Thermal
Analysis: Vibration
Analytical Services
Consulting: Balance-of-Plant
Consulting: Computer-Aided Engineering
Consulting: License Renewal
Consulting: Litigation Support
Consulting: Management Information
Consulting: Materials Engineering
Consulting: Pipe Support
Consulting: Piping
Consulting: Plant Life Extension
Consulting: Problem Solving
Consulting: Reactor Vessel
Consulting: Regulatory Compliance
Consulting: Reliability Analysis
Consulting: Residual Life Assessment
Consulting: Root Cause Analysis
Consulting: Steam Generators
Consulting: Strategic Planning
Consulting: Stress, Material
Consulting: Structural
Consulting: Thermal Analysis
Consulting: Third Party Review
Consulting: Verification & Validation
Design Services
Ductwork
Engineering Services
Engineering: Design
Engineering: Materials
Engineering: Mechanical
Engineering: Structural

• **Pawling Engineered Products,**

157 Charles Colman Blvd., Pawling, NY 12564; Phone: (845) 855-1000, Fax: (845) 855-1139, Http://www.pawling.com, Email: cbusby@pawling.com, Contact: Craig Busby.
(See advertisement on page 76)

Gaskets: Radiation Resistant
Seals
Seals: Flat
Seals: Inflatable

Penn Iron Works, Inc.,

700 Old Fritztown Rd., P.O. Box 6858, Wyomissing, PA 19610-6858; Phone: (610) 777-7656 x212, Fax: (610) 777-2327, Http://www.penniron.com, Email: sphilippides@penniron.com, Contact: S.A. Philippides.

Fabrications
Machines: Milling
Machining
Metal Fabrication
Metal Fabrication: Nickel & Nickel Alloy
Metal Fabrication: Stainless Steel
Metal Fabrication: Steel
Pipe Fabrication
Pipe: High-Alloy Steel

Pipe: Low-Alloy
Pipe: Stainless Steel
Pressure Vessels
Welding
Welding: ASME Code



• **Power House Tool, Inc.,**

626 Nicholson Street, Joliet, IL 60435; Phone: (815) 727-6301, Fax: (815) 727-4835, Http://www.powerhousetool.com, Email: lpatterson@powerhousetool.com, Contact: Laura Patterson.
(See advertisement on page 16)

Bolt Heaters
Calibration Instruments
Heaters: Electric
Heating Equipment: Electric Resistance
Maintenance: Equipment

PPS Access Screening,

P.O. Box 189, Arden, NC 28704; Phone: (828) 684-5960, Fax: (828) 684-2553, Email: pps@ppsaccessscreening.com, Contact: Cynthia Miller.

Investigations: unescorted Access Screenings

Precision Custom Components, LLC,

500 Lincoln St., York, PA 17404; Phone: (717) 848-1126, X2362, Fax: (717) 843-5733, Http://www.pcc-york.com, Email: jstouch@pcc-york.com, Contact: James C. Stouch.

Accumulators
ASME Certificate Holder
Casks: Storage
Casks: Transport
Cladding
Containers: Lead
Containers: Radwaste
Containers: Shielded
Containers: Steel
Containers: Transport
Containers: Waste
Decontamination Equipment (Cask)
Equipment: Safety-Related
Fabrications
Fuel Casks: Barge
Fuel Casks: Rail
Fuel Handling Equipment
Fuel Storage Facilities
Fuel Storage Racks
Fuel: Transport Flasks
Glove Boxes
Heat Exchangers
Machining
Machining: Compressors
Machining: Generators
Machining: Heat Exchanger
Machining: Pumps
Machining: Rotor
Machining: Safety-Related
Machining: Turbine
Material: ASME Code
Metal Fabrication
Metal Fabrication: Stainless Steel
Metal Fabrication: Steel
Metal Fabrication: Titanium
Metal Facing
NPT Stamp Holder
Nuclear Cask: Lead Hot Pours
Pressure Vessels
Pressurizers
Primary-Side Piping

Reactor Core Components
 Reactor Core Structure
 Reactor Head Repair
 Reactor Internals
 Reactor Vessel Components
 Separators
 Spent Fuel Storage Products
 Steam Generators
 Steam/Water Separators
 Storage: Spent Fuel
 Tanks: Chemical
 Tanks: Pressure
 Tanks: Stainless Steel
 Tube Bundle Components
 Vessel Fabrication
 Welding
 Welding Developments
 Welding: ASME Code
 Welding: Automated
 Welding: Hardfacing
 Welding: Narrow Groove, Automatic
 Welding: Overlay, Automatic
 Welding: Special

• **Proto-Power Corporation,**

15 Thames St., Groton, CT 06340; Phone: 860-446-8292, Fax: 860-405-3054, [Http://www.protopower.com](http://www.protopower.com), Email: ApicelliL@zhi.com, Contact: Lisa Apicelli.

(See advertisement on page 26)

Analysis: Engineering
 Analysis: Finite Element
 Analysis: Heat Transfer
 Analysis: Hydraulic
 Analysis: Root Cause
 Analysis: Safety
 Analysis: Stress
 Analysis: Structural
 Analysis: Support
 Analysis: Thermal
 Analysis: Vibration
 Consulting: Ancillary Systems Design
 Consulting: Appendix R
 Consulting: Balance-of-Plant
 Consulting: Computer Software
 Consulting: Control Systems
 Consulting: Cooling Systems
 Consulting: Data Acquisition Systems
 Consulting: Decommissioning
 Consulting: Design Assessment
 Consulting: Design Basis Documentation
 Consulting: Design Reports
 Consulting: Electrical
 Consulting: Engineering
 Consulting: Engineering Mechanics
 Consulting: Erosion/Corrosion Program
 Consulting: Fire Protection
 Consulting: Fluid Dynamic Analysis
 Consulting: Fluid Flow
 Consulting: FSAR Licensing Review
 Consulting: Heat Exchangers
 Consulting: Heat Transfer
 Consulting: HVAC Systems
 Consulting: Hydraulic
 Consulting: Instrumentation & Calibration
 Consulting: License Renewal
 Consulting: Life Cycle Management
 Consulting: Margin Management Programs
 Consulting: Modifications
 Consulting: Nuclear Steam Supply System
 Consulting: Pipe Support
 Consulting: Piping
 Consulting: Plant Life Extension
 Consulting: Plant Performance Analysis
 Consulting: Plant Performance Improvement
 Consulting: Project Management
 Consulting: Quality Assurance
 Consulting: Regulatory Compliance
 Consulting: Root Cause Analysis
 Consulting: Setpoint Analyses
 Consulting: Structural
 Consulting: System Design
 Consulting: System Safety
 Consulting: Technical Assessments

Consulting: Thermal Analysis
 Consulting: Thermal-Hydraulics
 Consulting: Third Party Review
 Consulting: Trend Analysis Program
 Consulting: Ventilation System
 Control Panel Design
 Control Systems
 Data Acquisition Systems
 Database Design/Development
 Design Basis Reconstitution
 Design Services
 Design: Electrical
 Design: Mechanical
 Design: Seismic
 Design: Structural
 Engineering Services
 Engineering Services: BWR
 Engineering Services: PWR
 Engineering: Control
 Engineering: Design
 Engineering: Electrical
 Engineering: Instrumentation
 Engineering: Mechanical
 Engineering: Nuclear
 Engineering: Power Uprate
 Engineering: Quality
 Engineering: Structural
 Engineering: Systems
 Environmental Qualification
 Fire Protection
 Heat Exchanger Analysis/Inspection Services
 Heat Exchangers: Studies
 Instrumentation/Control Systems
 Licensing Support Services
 Modeling: Plant Systems
 Models: Heat Exchanger
 Models: HVAC Systems
 Models: Power Plant
 Models: Power Plant, Database
 Models: Thermal Hydraulic System
 Piping Analysis
 Piping Design
 Safety Assessment
 Safety Evaluations: Preparation
 Security System Design
 Security System Upgrades
 Seismic Analysis
 Software Development
 Software Validation
 Software Verification
 Software: Plant Modeling
 Software: Plant Performance
 Software: Power Systems Analysis
 Software: Process Control
 Staff Support: Engineering

PTP Spent Fuel Services, LLC.,

P.O. Box 553, Grand Island, NY 14072; Phone: (866) 699-5515, Fax: (716) 773-5515, [Http://www.ptpsfs.com](http://www.ptpsfs.com), Email: PTP@ptpsfs.com, Contact: Bill Schaab.

Decontamination Services
 Fuel Pool Cleanup
 Fuel: Spent, Transport
 Radwaste Handling
 Spent Fuel Technology



R. Brooks Associates, Inc.,

6546 Pound Rd., Williamson, NY 14589; Phone: (315) 589-4000, Fax: (315) 589-4089, [Http://www.rbrooks.com](http://www.rbrooks.com), Email: baweir@rbrooks.com, Contact: Bruce Weir.

Camera Systems: Miniature
 Cameras: Closed-Circuit Television
 Cameras: High-Temperature
 Cameras: Inspection
 Cameras: Underwater
 Cleaning: Steam Generator

Condenser Analysis/Inspection Services
 Consulting: Information Management
 Consulting: In-Service Inspection Programs
 Consulting: Remote Systems Applications
 Consulting: Robotics
 Consulting: Steam Generators
 Consulting: Television Systems
 Decontamination Processes
 Inspection Equipment: Development
 Inspection Equipment: Robotic
 Inspection Equipment: Visual
 Inspection Equipment: Visual Inspection Services
 Inspection: Balance-of-Plant
 Inspection: Equipment
 Inspection: Feedwater Nozzle
 Inspection: In-Service
 Inspection: In-Vessel
 Inspection: Pipeline
 Inspection: Pressure Vessel
 Inspection: Primary-Side Components
 Inspection: Reactor Internals
 Inspection: Remote
 Inspection: Remote
 Inspection: Secondary Side Components
 Inspection: Steam Generator
 Inspections: Underwater
 Loose Part Retrieval
 Measurement Systems
 Measurement Systems: Photogrammetric Monitors
 Nondestructive Testing Inspections
 Pipe Crawlers
 Piping Inspection
 R&D Nondestructive Services
 R&D Services
 R&D: Nondestructive Testing
 Robotic Handling Equipment
 Robotic Handling Equipment
 Robots and Robotic Equipment
 Robots and Robotic Equipment
 Software: Remote Handling
 Software: Robotic System
 Steam Generator Maintenance
 Technology Transfer
 Testing: Remote Visual
 Turbine Boresonic Examination
 Turbine Inspection
 Video Inspection Services

RCM Technologies, Inc.,

2500 McClellan Avenue, Pennsauken, NJ 08109; Phone: (856) 317-0200, x113, Fax: (856) 486-0802, [Http://www.rcmt.com](http://www.rcmt.com), Email: rich.timer@rcmt.com, Contact: Richard Timer.

Consulting
 Design Services
 Engineering Services
 Environmental Qualification
 Licensing Support Services
 Modifications
 Outage Support Services
 Staff Support

Reef Industries, Inc.,

9209 Alameda Genoa, Houston, TX 77075; Phone: (800) 231-6074, Fax: (713) 507-4387, [Http://www.reefindustries.com](http://www.reefindustries.com), Email: tscarborough@reefindustries.com, Contact: Tom Scarborough.

Bags
 Bags: Asbestos
 Containers: Storage Products
 Containment Products: DOT
 Containment Tents
 Incinerable Products
 Insulation Materials
 Liners
 Radwaste Packaging
 Radwaste Polybags
 Sheeting: Plastic
 Slewing
 Spent Fuel Storage Products
 Storage Equipment
 Storage Systems: Onsite

Rigging International,

1210 Marina Village Pkwy., P.O. Box 1285, Alameda, CA 94501; Phone: (510) 865-2400, Fax: (510) 865-9450, [Http://www.rigginginternational.com](http://www.rigginginternational.com), Email: info@rigginginternational.com, Contact: Shayrun Ali.

Decommissioning Services
 Fuel Casks: Barge
 Fuel Casks: Rail
 Fuel Storage Facilities
 Reactor Head Removal Services
 Rigging
 Steam Generator Disposal
 Steam Generator Replacement
 Transformer Replacement Services
 Transport: Heavy

Sargent & Lundy,

55 E. Monroe St., Chicago, IL 60603; Phone: (312) 269-2000, Fax: (312) 269-3680, [Http://www.sargent-lundy.com](http://www.sargent-lundy.com), Email: thinkingpower@sargentlundy.com, Contact: Bob Schuetz.

Analysis: Dynamic
 Analysis: Engineering
 Analysis: Environmental
 Analysis: Hydraulic
 Analysis: Reliability
 Analysis: Risk
 Analysis: Root Cause
 Analysis: Severe Accident
 Analysis: Stress
 Analysis: Structural
 Analysis: Thermal
 Analysis: Waste
 Assessment: Plant Condition
 Audit Support: Technical Specialist
 Audits: Quality
 Availability Improvements
 Commercial-Grade Dedication
 Computers: Upgrades
 Configuration Management
 Consulting
 Consulting: Ancillary Systems Design
 Consulting: Appendix R
 Consulting: Balance-of-Plant
 Consulting: Business Management
 Consulting: Computer Systems
 Consulting: Configuration Management
 Consulting: Data Acquisition Systems
 Consulting: Decommissioning
 Consulting: Decontamination
 Consulting: Design & Documentation
 Consulting: Design Basis Documentation
 Consulting: Digital Systems
 Consulting: Economic Analysis
 Consulting: Electrical
 Consulting: Engineering
 Consulting: Environmental
 Consulting: Fire Protection
 Consulting: Fluid Dynamic Analysis
 Consulting: FSAR Licensing Review
 Consulting: Hazardous Waste Management
 Consulting: HVAC Systems
 Consulting: Information Management
 Consulting: In-Service Inspection Programs
 Consulting: Instrumentation & Calibration
 Consulting: License Renewal
 Consulting: Licensing
 Consulting: Life Cycle Management
 Consulting: LOCA Analysis
 Consulting: Maintenance
 Consulting: Maintenance Programs
 Consulting: Management
 Consulting: Material Management
 Consulting: Materials Engineering
 Consulting: Modifications
 Consulting: Nuclear
 Consulting: Operations
 Consulting: Outage Management
 Consulting: Piping
 Consulting: Plant Life Extension
 Consulting: Plant Performance Improvement
 Consulting: Preventive Maintenance
 Consulting: Program Assessment

Consulting: Prudence Studies
 Consulting: Quality Assurance
 Consulting: Quality Control
 Consulting: Radiation Analysis
 Consulting: Radwaste
 Consulting: Records Management Systems
 Consulting: Regulatory Compliance
 Consulting: Reliability Analysis
 Consulting: Residual Life Assessment
 Consulting: Risk Analysis
 Consulting: Root Cause Analysis
 Consulting: Security
 Consulting: Seismic
 Consulting: Self-Assessment
 Consulting: Setpoint Analyses
 Consulting: Siting
 Consulting: Strategic Planning
 Consulting: Structural
 Consulting: System Design
 Consulting: Technical Assessments
 Consulting: Thermal Analysis
 Consulting: Thermal-Hydraulics
 Consulting: Third Party Review
 Consulting: Valve Actuators
 Consulting: Valves
 Consulting: Waste Management
 Consulting: Water Treatment
 Corrosion Control
 Data Management Systems
 Database Design/Development
 Decommissioning Services
 Design Basis Reconstitution
 Design Services
 Design: Electrical
 Design: Mechanical
 Design: Seismic
 Design: Structural
 Diesel Generator Engineering Studies
 Engineering Services
 Engineering Services: BWR
 Engineering Services: PWR
 Engineering: Civil
 Engineering: Control
 Engineering: Cost
 Engineering: Design
 Engineering: Electrical
 Engineering: Environmental
 Engineering: Instrumentation
 Engineering: Maintenance
 Engineering: Materials
 Engineering: Mechanical
 Engineering: Nuclear
 Engineering: Power Uprate
 Engineering: Structural
 Engineering: Systems
 Environmental Qualification
 Equipment Qualification
 Failure Analysis
 Foundation Design & Analysis
 HVAC Systems
 Information Management Systems
 Inspection: In-Service
 Licensing Support Services
 Life Extension
 Maintenance Management Systems
 Maintenance Program Evaluation
 Maintenance Services
 Maintenance: Predictive
 Maintenance: Preventive
 Maintenance: Reliability Centered
 Management: Construction
 Modeling: Plant Systems
 Modifications
 Outage Management
 Outage Planning
 Outage Support Services
 Piping Analysis
 Piping Design
 Plant Upgrading/Upgrading
 Probabilistic Risk Assessment
 Probabilistic Safety Analysis
 Procedure Development
 Process Control Systems
 Project Management
 Quality Assurance Services
 Quality Control Services

Quality Improvement Programs
 Radiation Assessment
 Radwaste Analysis
 Records Management
 Safety Analysis
 Safety Evaluations: Preparation
 Safety Evaluations: Program Reviews
 Security System Design
 Security System Upgrades
 Security: Hazards Analysis
 Seismic Analysis
 Seismic Qualification
 Shielding Analysis
 Snubber Analysis
 Software
 Software Development
 Software: Custom
 Software: Database Management
 Software: Document Control
 Software: Engineering Applications
 Software: Inventory Management
 Software: Maintenance
 Software: Plant Modeling
 Staff Support
 Staff Support: Designers
 Staff Support: Engineering
 Staff Support: Executive
 Staff Support: Instrumentation/Control
 Staff Support: Modifications
 Staff Support: Outage
 Staff Support: Planners
 Staff Support: Quality Assurance/Control
 Staff Support: Technical
 Structural Integrity Assessment
 Support Services: Operating Plant
 Technology Transfer
 Training Support
 Training: Quality Assurance
 Training: Quality Improvement
 Training: Technical Staff
 Waste: Mixed, Analysis

Scientech,

6110 Fieldcrest Drive, Frederick, MD 21701; Phone: (301) 668-1033, Fax: (301) 682-9209, [Http://www.scientech.com](http://www.scientech.com), Email: dmurphy@scientech.com, Contact: Donald Murphy.

Access Processing Software
 Alarm Monitoring System
 Alarms: Electronic Modules
 Alarms: Safety-Related
 Analysis: Chemical
 Analysis: Criticality
 Analysis: Engineering
 Analysis: Finite Element
 Analysis: Material Identification
 Analysis: Reliability
 Analysis: Risk
 Analysis: Safety
 Analysis: Severe Accident
 Analysis: Thermal
 Anti-friction Bearings: Safety-Related
 Assemblies: Printed Circuit
 Assessments: Operations Experience
 Bargraphs: Class 1E
 Battery Chargers
 Bolt Tensioning Systems
 Bolt Tensioning: Precision
 Cable Assemblies
 Cable Assemblies: Cont Rod Position Indicator
 Cable Assemblies: Control Rod Drive Mechanism
 Cable Assemblies: Core Monitoring
 Cable Assemblies: Electronic
 Cable Assemblies: Fiber Optic
 Cable Assemblies: Radiation Resistant
 Cable Assemblies: Thermocouple
 Cavity Seal Rings
 Chambers: Explosion Proof
 Chemistry Data Management Systems
 Chemistry Services
 Circuit Breaker Maintenance
 Circuit Breaker Retrofitting
 Circuit Breakers: Low-Voltage Air, Safety-Related
 Circuit Breakers: Molded Case, Safety-Related

- Circuit Breakers: Safety-Related
- Cleaners: RV Flange
- Cleaners: RV Stud
- Cleaners: RV Stud Hole
- Cleaning Equipment
- Coatings
- Commercial-Grade Dedication
- Computers: Plant Process
- Connections: Electrical
- Connectors
- Connectors: Circuit Board
- Connectors: Electrical
- Connectors: Quick Disconnect
- Connectors: Quick Disconnect, Safety-Related
- Consulting: Data Acquisition Systems
- Consulting: Emergency Preparedness
- Consulting: Engineering
- Consulting: Engineering: BWR
- Consulting: Fire Protection
- Consulting: FSAR Licensing Review
- Consulting: Information Management
- Consulting: Instrumentation & Calibration
- Consulting: IPEEE
- Consulting: License Renewal
- Consulting: Licensing
- Consulting: Life Cycle Management
- Consulting: LOCA Analysis
- Consulting: Management Information
- Consulting: Material Management
- Consulting: Nuclear
- Consulting: Nuclear Steam Supply System
- Consulting: Plant Performance Analysis
- Consulting: Plant Performance Improvement
- Consulting: Procedure Development
- Consulting: Procedure Validation
- Consulting: Procedure Verification
- Consulting: Procurement Support
- Consulting: Quality Assurance
- Consulting: Reactor Safety
- Consulting: Regulatory Compliance
- Consulting: Reliability Analysis
- Consulting: Risk Analysis
- Consulting: Security
- Consulting: System Safety
- Consulting: Vendor Manual Upgrades
- Contactors: Safety-Related
- Control Panel Design
- Control Panels: IE
- Control Panels: Safety-Related
- Control Rod Control System Maintenance
- Control Rod Control Systems
- Control Rod Drive Maintenance
- Control Room Consoles: Class 1E
- Control Systems: Class 1E
- Controllers: Analog
- Controllers: Programmable
- Converters: Safety-Related
- Coolant Circulators
- Counters: Fission
- Covers
- Crane Control Systems
- Crane Controls
- Crane Retrofits
- Crane Retrofits: Single-Failure-Proof
- Crane Service
- Cranes
- Cranes: Fuel Building (Cask Handling)
- Cranes: Fuel Pool
- Dampeners: Pulsation
- Damper Operators
- Dampers: Backdraft
- Dampers: Bubble Tight
- Dampers: Control
- Dampers: Electric
- Dampers: Fire
- Dampers: Fire, Testing
- Dampers: High-Pressure
- Dampers: Isolation
- Dampers: Manual
- Dampers: Pneumatic
- Dampers: Relief
- Dampers: Tornado
- Dampers: Volume
- Data Acquisition Systems
- Data Management Systems
- Design Services
- Design: Control Panel
- Design: Electrical
- Design: Mechanical
- Doors: Manway
- Dosimeters: Direct Reading
- Electronic Components and Equipment
- Electronic Procedures
- Emergency Planning
- Engineering Services
- Engineering Services: BWR
- Engineering Services: PWR
- Engineering: Cost
- Engineering: Design
- Engineering: Electrical
- Engineering: Mechanical
- Engineering: Nuclear
- Engineering: Power Uprate
- Environmental Qualification
- Equipment Qualification
- Equipment Qualification: Components, ASME
- Equipment Reliability
- Equipment Replacement
- Equipment: Safety-Related
- Fabrications
- Fire Protection
- Fittings
- Fittings: Flow Control
- Fuel Consolidation Equipment
- Fuel Handling Equipment
- Fuel Storage Facilities
- Fuel Transfer System Maintenance
- Fuel Transfer Systems
- Fuse Holders: Safety-Related
- Fuses: Safety-Related
- Gauges: Pressure
- Gauges: Vacuum
- Grease Analysis
- Grills
- Health Physics Services
- Hoists
- Hose Assemblies: Metal
- I/O Controllers
- Indicator Lights: Safety-Related
- Indicators
- Indicators: Panel Mounted
- Information Management Systems
- Information Services
- Information Services: Equipment Qualification
- Information Services: Inspection Enforcement
- Instrument Power Supplies
- Instrument Signal Isolation Devices
- Instrumentation
- Instrumentation/Control Systems
- Instrumentation/Control Systems: Class 1E
- Instrumentation/Control Systems: Repair
- Instrumentation/Control: Part Replacement
- Instrumentation: Nuclear
- Instrumentation: Process Control
- Instruments
- Instruments: Electronic
- Instruments: Safety-Related
- Inventory Management
- Inventory Tracking Systems
- Isolators: Analog Signal
- Isolators: Digital Signal
- Licensing Support Services
- Licensing: Technical Specifications
- Life Extension
- Life Extension: Plant
- Life Extension: Plant, BWR
- Maintenance: Reliability Centered
- Manway Closure Services
- Manway Cover Handling System
- Materials Handling Equipment
- Materials Management
- Metal Fabrication
- Metal Fabrication: Aluminum
- Metal Fabrication: Nickel & Nickel Alloy
- Metal Fabrication: Stainless Steel
- Metal Fabrication: Steel
- Metal Fabrication: Titanium
- Modeling: Plant Systems
- Monitoring Systems: Plant Safety
- Motor Control Center Refurbishment
- Motor Control Centers: Safety-Related
- Motor Control Centers: Safety-Related Parts
- Motor Starters: Safety-Related
- Motors: Safety-Related
- Nozzle Dam Installation
- Nozzle Dams
- Operation Procedure Upgrades
- Outage Support Services
- Panels: Custom, Safety-Related
- Panels: Instrument
- Panels: Power Distribution, Safety-Related
- Panels: Safety-Related
- Parts Evaluation
- Parts: BWR Spare
- Parts: O.E.M.
- Parts: Procurement Assistance
- Parts: Replacement
- Parts: Replacement, Design
- Parts: Spare
- Parts: Used
- Penetrations: Containment
- Penetrations: Electrical
- Penetrations: Electrical, Adaptor Modules
- Pigs: Pipeline
- Plugs
- Plugs: Recirculation Pipe
- Plugs: Stud Hole
- Plugs: Thimble
- Power Supplies: Safety-Related
- Probabilistic Risk Assessment
- Probabilistic Risk Assessment: BWR
- Probabilistic Safety Analysis
- Procedure Development
- Procurement
- Procurement Management
- Qualification: Supplier
- Quality Assurance
- Quality Assurance Services
- Quality Control Services
- R&D: Instrumentation/Control Systems
- Reactor Protection Systems
- Reactor Services
- Records Management
- Recovery: Asset
- Refueling Equipment
- Refueling Equipment: Refurbishing
- Regulatory Compliance
- Regulatory Compliance: 10CFR50.59
- Regulatory Compliance: 10CFR50.65
- Relays: Safety-Related
- Risk Assessment
- Rod Control Maintenance Services
- Safety Analysis
- Safety Assessment
- Safety Equipment
- Safety Evaluations: Preparation
- Sealants: Pipe Thread
- Sealing Systems: Quick-Disconnect
- Sealing: Fluid
- Sealing: Penetration
- Seals: Conduit
- Seals: Hydrostatic
- Seals: Inflatable
- Seals: Steam Generator
- Security System Design
- Security Systems
- Security: Hazards Analysis
- Seismic Analysis
- Seismic Analysis/Testing Equipment
- Seismic Qualification
- Shielding Analysis
- Software: Database Management
- Software: Inventory Management
- Software: Materials Management
- Software: Nuclear Safety
- Software: Plant Performance
- Software: Probabilistic Safety Analysis
- Software: Radiological Data Management
- Software: Records Management
- Software: Trending
- Staff Augmentation—See Staff Support
- Steam Generator Maintenance Equipment
- Stud Tensioning Systems
- Switchboards: Safety-Related
- Switches: Flow
- Switches: Level
- Switches: Limit

Switches: Pressure, Safety-Related
 Switches: Temperature, Safety-Related
 Switchgear: Safety-Related
 Tape: Electrical
 Tensioning Rings: Hand-Hole
 Tensioning Rings: Manway
 Terminal Blocks: Safety-Related
 Terminals: Safety-Related
 Testing: Acceptance
 Testing: Irradiation
 Testing: Laboratory
 Testing: LOCA Conditions
 Testing: Mechanical
 Testing: Mechanical & Irradiation
 Testing: Safety-Related Components
 Tools: Control Rod Drive Handling
 Tools: LPRM Handling
 Training: Chemistry
 Training: Nuclear Simulator
 Training: Operations Personnel
 Training: Procurement
 Training: Safety Evaluations
 Transducers: Pressure
 Transducers: Safety-Related
 Transfer Switches: 1E
 Transformers: Safety-Related
 Transmitters: Diff. Press., Safety-Related
 Transmitters: Safety-Related
 Uninterruptible Power Supply: Safety-Related
 Valve Actuator
 Valve Actuator Parts
 Valve Actuators: Electric
 Valve Actuators: Electromechanical
 Valve Actuators: Mechanical
 Valve Actuators: Pneumatic
 Valve Analysis
 Valve Positioners
 Valves: Safety-Related



Sonic Systems International, Inc.,
 1880 Dairy Ashford, Ste. 207, Houston, TX 77077;
 Phone: (281) 531-7611 ext.15, Fax: (281) 531-7595,
 Http://www.ssi-group.net, Email: ganderson@ssi-
 group.net, Contact: Gregg Anderson.

Audits: Quality
 Consulting: Quality Assurance
 Consulting: Quality Control
 Corrosion Surveys
 Engineering: Quality
 Fuel Floor Support
 Fuel Inspection
 Hose Assemblies: Plastic
 Inspection
 Inspection: Balance-of-Plant
 Inspection: In-Service
 Inspection: Quality Control
 Inspection: Reactor Internals
 Inspection: Vessel Welds, BWR
 Inspections: Underwater
 NDE Services
 NDE Services: Ultrasonic
 NDE: Section XI Support
 Nondestructive Testing Services
 Outage Planning

Outage Support Services
 Qualification: Supplier
 Quality Assurance
 Quality Assurance Services
 Quality Control Services
 Staff Support: Engineering
 Staff Support: Nondestruction Examination
 Staff Support: Outage
 Staff Support: Planners
 Staff Support: Quality Assurance/Control
 Training: Nondestructive Testing
 Training: Quality Assurance
 Training: Quality Auditor
 Training: Quality Control

Southern Testing Services,
a Division of ATC,
 10627 Lexington Drive, Knoxville, TN 37932; Phone:
 (865) 966-5330, Fax: (865) 675-5399, Http://www.
 argoturbo.com, Email: southerntesting@argoturbo.
 com, Contact: Rich Crawford.

Controllers: Programmable
 Equipment: Safety-Related
 Instrumentation/Control Systems
 Materials: Qualified
 Qualification: Supplier
 Seismic Analysis/Testing Equipment
 Seismic Qualification
 Testing

Spectrum Technologies,
a Division of ATC,
 112 Erie Boulevard, Schenectady, NY 12305; Phone:
 (518) 382-0056, Fax: (518) 382-0283, Http://www.
 argoturbo.com, Email: spectrum@argoturbo.com,
 Contact: George Kuhn.

Equipment: Safety-Related
 Instrumentation/Control Systems
 Materials: Qualified
 Motor Control Centers: Safety-Related
 Parts: O.E.M.
 Parts: Spare
 Qualification: Supplier
 Testing

• **SSM Industries, Inc.,**
 3401 Grand Ave., Pittsburgh, PA 15225-1507; Phone:
 (412) 777-5101 X-363, Fax: (412) 771-5382, Http://
 www.ssiworld.com, Email: m.saucier@ssmi.biz,
 Contact: Mark Saucier.
(See advertisement on page 32)

Actuators
 Air Conditioning: Packaged
 Air Filtration Units
 Air Handling Units
 Damper Operators
 Dampers: Backdraft
 Dampers: Bubble Tight
 Dampers: Control
 Dampers: Electric
 Dampers: Fire
 Dampers: Fire, Testing
 Dampers: High-Pressure
 Dampers: Isolation
 Dampers: Manual
 Dampers: Pneumatic
 Dampers: Relief
 Dampers: Tornado
 Dampers: Volume
 Doors: Access
 Doors: Bullet Proof
 Doors: Marine
 Doors: Plenum
 Doors: Radiation Shielding
 Ductwork
 Ductwork Hangers
 Ductwork Supports
 Equipment: Safety-Related
 Fabrications
 Fans: Axial
 Fans: Centrifugal
 Fans: Exhaust
 Fans: High-Pressure

Fans: Ventilating
 Filter Housings
 Filtration Equipment
 Glove Boxes
 HVAC Construction
 HVAC Systems: Installation
 HVAC: Ventilation Equipment
 Louvers
 Metal Fabrication
 Metal Fabrication: Aluminum
 Metal Fabrication: Nickel & Nickel Alloy
 Metal Fabrication: Stainless Steel
 Metal Fabrication: Steel
 Panels: Custom, Safety-Related
 Systems: HVAC
 Valve Actuators: Electric
 Valve Actuators: Electrohydraulic
 Valve Actuators: Electromechanical
 Valve Actuators: Pneumatic

Staubli Corporation,
 201 Parkway West, Duncan, SC 29334; Phone: (864)
 433-1980, Fax: (864) 486-5498, Http://www.staubli.
 com, Email: a.brake@staubli.com, Contact: Andreas
 Brake.

Connectors
 Connectors: Electrical
 Connectors: Electrical, Ceramic-to-Metal
 Connectors: Electrical, Hot Cell
 Connectors: Fluid, Hot Cell
 Connectors: Quick Disconnect
 Connectors: Quick Disconnect, Safety-Related
 Robots and Robotic Equipment

Studsvik

• **Studsvik, Inc.,**
 5605 Glenridge Dr., NE, Suite 705, Atlanta, GA
 30342; Phone: (404) 497-4910, Fax: (404) 497-4901,
 Http://www.studsvik.com, Email: tom.duberville@
 studsvik.com, Contact: Tom Duberville.
(See advertisement on page 73)

Decommissioning Services
 Decontamination Services: Offsite
 Dewatering Equipment
 Dewatering Services
 Fuel Rack Disposal
 Outage Support Services
 Project Management
 Radwaste
 Radwaste Disposal Services
 Radwaste Management Services
 Radwaste Processing
 Radwaste Reduction System Design
 Radwaste Transportation
 Radwaste Treatment Services
 Radwaste Volume Reduction
 Remediation Projects
 Remediation Services
 Steam Generator Disposal
 Waste Management Services
 Waste Processing
 Waste: Liquid, Concentrators
 Water Treatment: Waste

T. D. Williamson, Inc.,
 565 Anderson Dr., Unit A, Romeoville, IL 60446;
 Phone: (800) 828-1988, Fax: (815) 407-0675, Http://
 www.tdwilliamson.com, Email: gary.bucholz@tdwil-
 liamson.com, Contact: Gary Bucholz.

Figs: Pipeline
 Pipe Freezing
 Piping Repair
 Piping Replacement
 Plugs: Freeze
 Valves: Isolation

Talisman International, LLC,
1000 Potomac St. NW, Ste. 300, Washington, DC
20007; Phone: (202) 471-4244, Fax: (202) 471-4360,
Http://www.talisman-intl.com, Email: hthompson@
talisman-intl.com, Contact: Hugh Thompson.

Consulting: Computer Network Intrusion Prevention
Consulting: Computer Network Risk Assessment
Consulting: Computer Network Security
Consulting: Computer Network Security Training
Consulting: Decommissioning
Consulting: Environmental Analysis
Consulting: Information Management
Consulting: Licensee Event Reports
Consulting: Litigation Support
Consulting: Management Effectiveness Reviews
Consulting: Prudence Studies
Consulting: Regulatory Compliance
Consulting: Risk Management
Consulting: Third Party Review

tecnatom, s.a.

- **Tecnatom, S.A.,**
Avenue Montes de Oca 1, 28709 San Sebastian de los
Reyes, Madrid Spain; Phone: 34 91 6598600, Fax: 34
91 6598677, Http://www.tecnatom.es, Email: correo@
tecnatom.es, Contact: Juan Ortega.
(See advertisement on page 77)

Analysis: Engineering
Communications Systems
Computer System Development
Consulting: Engineering
Consulting: Engineering Mechanics
Consulting: Environmental Analysis
Consulting: In-Service Inspection Programs
Consulting: Instrumentation & Calibration
Consulting: Materials Engineering
Consulting: Operations
Consulting: Operations Analysis
Consulting: Plant Life Extension
Consulting: Quality Control
Consulting: Remote Systems Applications
Consulting: Training
Contract Engineering Services
Control Systems
Engineering Services
Inspection Equipment: Development
Inspection Equipment: Robotic
Inspection Equipment: Visual
Inspection Procedure Validation
Inspection Services
Instrumentation/Control System Calibration
Instrumentation/Control System Maintenance
Nondestructive Testing & Evaluation
Nondestructive Testing Equipment
Nondestructive Testing Inspections
Nondestructive Testing Services
Nondestructive Testing: Eddy Current
Simulator Training
Training: Nuclear Simulator

The Delphi Groupe, Inc.,
2211 S. IH-35, Ste. 400, Austin, TX 78741; Phone:
(512) 462-1181, Fax: (512) 462-1187, Http://www.
delphigroupe.com, Email: mrandolph@delphigroupe.
com, Contact: Mark Randolph.

Consulting: Computer Software
Consulting: Engineering
Consulting: Radwaste
Decommissioning Services
Emergency Preparedness Program Development
Emergency Preparedness: Staff Support
Engineering: Design
Engineering: Electrical
Engineering: Mechanical
Health Physics
Procedure Development
Project Management
Safety: Industrial
Safety: Radiological

Staff Support: 10CFR20 Implementation
Staff Support: Engineering
Staff Support: Health Physics
Staff Support: Industrial Hygiene
Staff Support: Outage
Training: Program Development Services

- **The Shaw Group Inc.,
Nuclear Power Division,**
128 S. Tryon St., Charlotte, NC 28202; Phone: (856)
482-3000, Fax: (865) 482-4028, Http://www.shawgrp.
com, Email: alan.latti@shawgrp.com, Contact: Alan
W. Latti, P.E..
(See advertisement on page 29)

Commissioning Services
Construction
Decommissioning Services
Decontamination
Design Services
Engineering: Nuclear
Engineering Services
Maintenance
Modifications
Outage Management
Pipe Fabrication
Procurement
Reactors: PWR
Remediation
Startup Services

ThermoFisher SCIENTIFIC

- **Thermo Fisher Scientific,
Scientific Instrument Division CIDTEC Cameras
& Imagers,**
101 Commerce Blvd., Liverpool, NY 13088; Phone:
(315) 451-9410, Fax: (315) 451-9421, Http://www.
thermo.com/cidtec, Email: tony.chapman@thermo-
fisher.com, Contact: Tony Chapman.
(See advertisement on page 7)

Camera Systems: Miniature
Camera Tubes: Radiation Hardened Television
Cameras: Closed-Circuit Television
Cameras: Inspection
Cameras: Underwater
Image Intensifier: Neutron
Imaging Systems
Inspection Equipment: Development
Inspection Equipment: Visual
Television Systems: Closed-Circuit
Television Systems: Rad Hardened
Television Systems: Underwater, Rad Hardened
Video Inspection Systems

Thermo SCIENTIFIC

Thermo Scientific,
One Thermo Fisher Way, Oakwood Village, Ohio
44146; Phone: 440-703-1400, Fax: 440-703-1596,
Email: joseph.rotunda@thermofisher.com, Contact:
Joseph Rotunda.

Counters: Particle
Counters: Radiation
Detectors: Neutron
Detectors: Radiation
Dosimeters: Personal
Dosimeters: Radiation
Dosimetry Supplies: TLD

Dosimetry: Personnel
Dosimetry: TLD Systems
Instrumentation: Radiation Protection
Monitors: Personal
Monitors: Personnel Contamination
Monitors: Personnel Contamination
Monitors: Portal
Monitors: Portal Beta
Monitors: Portal Gamma
Monitors: Radiation
Radiation Detection/Monitoring Systems
Radiation Vehicle Monitoring Systems
Wireless Remote Systems: Dosimetry
Wireless Remote Systems: Radiation Monitors

**Thermo Scientific, Part of Thermo Fisher Scientific,
Process Instruments Div.,**
10010 Mesa Rim Rd., San Diego, CA 92121; Phone:
(800) 488-4399, Fax: (858) 452-9250, Http://www.
thermo.com/nuclear, Email: ussdi.customersupport@
thermofisher.com, Contact: Clark Artaud.

Cable Assemblies: Radiation Resistant
Cable: Safety-Related
Detectors: Ex-Core
Detectors: Gamma
Detectors: Neutron
Instrument Racks: Seismic Multibay
Instrument Signal Isolation Devices
Instrumentation/Control Systems: Class 1E
Instrumentation: Nuclear
Monitoring Systems: Neutron
Monitoring Systems: Neutron Flux
Monitors: Dose Rate
Monitors: Gamma
Monitors: Intermediate Range
Monitors: Source Range
Power Supplies: Safety-Related
Reactor Protection Systems

Tioga Pipe Supply Company Inc.,
2450 Wheatshaf Ln., Philadelphia, PA 19137;
Phone: (215) 831-0700, Fax: (215) 533-1645, Http://
www.tiogapipe.com, Email: jshaw@tiogapipe.com,
Contact: Jeff Shaw.

ASME Certificate Holder
Fabrications
Fasteners
Flanges
Forgings
Pipe
Pipe Fittings
Pipe Fittings: High-Alloy Steel
Pipe Fittings: Tee's
Pipe: Alloy
Pipe: Carbon-Steel
Pipe: Corrosion-Resistant
Pipe: High-Alloy Steel
Pipe: Stainless Steel
Tubing
Tubing: Stainless Steel



TRANTER,
1900 Old Burk Hwy, Wichita Falls, TX 76307; Phone:
(940) 723-7125, Fax: (940) 723-1131, Http://www.
tranter.com, Email: sales@tranter.com, Contact: Jody
Stonecipher.

Condensing Units: Water Cooled
Coolers: Direct Expansion (DX) Refrigerant
Evaporators
Feedwater Heaters
Heat Exchanger Maintenance

Heat Exchangers
Heat Exchangers
Pipe Heating Products

- **Underwater Construction Corporation,**
110 Plains Rd., Essex, CT 06426; Phone: (800) USA-DIVE, Fax: (860) 767-0612, Http://www.uc-dive.com, Email: cvallance@uccdive.com, Contact: Charles A. Vallance.
(See advertisement on page 56)

Coating Application Services
Coating: Underwater
Concrete Cutting
Concrete Services
Construction: Underwater
Cooling Water Intake Maintenance
Corrosion Control
Cutting Equipment: Underwater
Debris Recovery Services
Decommissioning Services
Diving
Filters: Underwater
Fuel Pool Cleanup
Fuel Pool Liners
Fuel Storage Racks
Fuel Transfer Systems
Inspection Services
Inspections: Underwater
Installation: Fuel Rack
Leak Detection Services
Leak Detection: Acoustic
Machining: Underwater
Maintenance Services: Underwater
Piping Repair
Radwaste Volume Reduction
Reactor Repair: Underwater, BWR
Repairs: Underwater
Thermal Shield Repair
Tooling: Underwater
Tools: Fuel Pin Transfer
Water Filtration Units
Weld Repair
Welding: ASME Code
Welding: Underwater Wet

- **UniStar Nuclear Energy,**
750 E. Pratt St. 14th Floor, Baltimore, MD 21202;
Phone: (410) 783-2800, Fax: (410) 470-5606, Http://www.unistarnuclear.com, Email: info@unistarnuclear.com, Contact: Mike McGough.
(See advertisement on page 4)

Consulting: Licensing
Operating Services
Reactors
Reactors: Advanced PWR
Reactors: PWR

- **UniTech Services Group, Inc.,
Div. of Unifirst Corp.,**
295 Parker St., P.O. Box 51957, Springfield, MA 01151; Phone: (413) 543-6911, X16, Fax: (413) 543-2975, Http://www.unitech.ws, Email: gjohnstone@unitech.ws, Contact: Gregg Johnstone.
(See advertisement on pages 22, 34, 47)

Bags
Bags: Laundry
Cleaning Equipment
Cleaning Service
Cleaning: CO2 Blast
Clothing: Protective
Clothing: Protective, Fabrics
Consulting: Chemistry
Containers: Storage
Containers: Transport
Decontamination
Decontamination Equipment
Decontamination Services
Decontamination Services: Offsite
Decontamination Supplies
Decontamination: CO2
Fabrics: Flame Retardant
Fabrics: Incinerable
Gloves: Protective
Grit Blasting

Health Physics Services
Health Physics Supplies
Hoods: Respirator
Incinerable Products
Laundry Services
Laundry: Water Wash
Maintenance: HEPA Systems
Monitors: Laundry Radioactivity
Outage Support Services
Pipe: Chemical Decontamination
Protective Clothing Lease
Pump: Chemical Decontamination
Radwaste Polybags
Radwaste Supplies
Radwaste Volume Reduction
Respirator Cleaning Equipment
Respirator Supply Systems
Respirators
Rope: Warning
Shoe Covers: Protective
Sleeving
Staff Support: Decontamination
Staff Support: Laundry Collection
Staff Support: Outage
Swipes: Decontamination
Tape: Duct
Tape: Warning
Tarps
Vacuums: HEPA-Filtered
Wipes: Decontamination
Wiping Cloths



Uticom Systems Inc.,
109 Independence way, Coatesville, PA 19320;
Phone: (610) 857-2986, Fax: (610) 857-2986, Email: jennifer@uticom.net, Contact: Jennifer Martin.

Cable Markers
Cable: Fiber Optic
Labels
Labels: Bar Coded
Labels: Warning
Markers: Fiber Optic
Markers: Industrial
Signs: Warning
Tags

Valcor Engineering Corporation,
2 Lawrence Rd., Springfield, NJ 07081; Phone: (973) 467-8480 EXT 7226, Fax: (973) 467-3365, Http://www.valcor.com, Email: stevegatcomb@valcor.com, Contact: Steve Gatcomb.

ASME Certificate Holder
Check Valve Application Review
Connectors: Quick Disconnect, Safety-Related
Diagnostics: Valve
Diagnostics: Valve Actuator
Equipment Qualification: Components, ASME
Instrumentation/Control Systems: Class 1E
Instrumentation: Nuclear
Instrumentation: Packless
Manifolds
Manifolds: Packless Globe and Instrumentation
Solenoid Operated Valve Applications
Solenoid Operated Valve Diagnostics
Solenoid Operated Valve Repair
Solenoids
Training: Valves & Valve Actuators
Valve Actuator
Valve Actuators: Electric
Valve Assemblies

Valve Diagnostic Systems
Valves
Valves: Air Operated Globe
Valves: Bellows Sealed
Valves: Check
Valves: Custom
Valves: Diaphragm
Valves: Diverter
Valves: Gate
Valves: Globe
Valves: High-Pressure
Valves: Isolation
Valves: Metering
Valves: Needle
Valves: Packless
Valves: Pilot
Valves: Safety-Related
Valves: Sampling
Valves: Solenoid



Valtimet Inc.,
5501 Air Park Blvd., Morristown, TN 37813; Phone: 423/587-1888, Fax: 423/585-4215, Http://www.valtimet.com, Email: us.contact@valtimet.com, Contact: Wendy McGowan.

Heat Exchangers: Tubes
Titanium
Tubing
Tubing: Stainless Steel
Tubing: Titanium

Velan Valve Corporation,
94 Ave. C, Griswold Industrial Park, Williston, VT 05495; Phone: (802) 864-3350, Fax: (802) 865-3030, Http://www.velan.com, Email: dbowers@velanvalve.com, Contact: Don Bowers.

Valve Analysis
Valve Parts
Valve Service Supervision
Valves: Air Operated Globe
Valves: Ball
Valves: Bellows Sealed
Valves: Butterfly
Valves: Check
Valves: Flanged
Valves: Gate
Valves: Globe
Valves: High-Pressure
Valves: Isolation
Valves: Knife Gate
Valves: Motor Operated
Valves: Motor Operated, Engineering
Valves: Needle
Valves: Safety-Related



Westerman Nuclear

- **Westerman Nuclear,**
245 N. Broad St., Bremen, OH 43107; Phone: (800) 338-8265, Fax: (740) 569-4111, [Http://www.westermancompanies.com](http://www.westermancompanies.com), Email: jchristian@westermancompanies.com, Contact: Jim Christian.
(See advertisement on page 72)

ASME Certificate Holder
Decontamination: Steel Equipment
Electrical Panels: Control
Equipment Qualification: Components, ASME
Equipment Replacement
Equipment: Safety-Related
Fabrications
Fittings: Welding
Heat Exchangers
Heat Exchangers
Heat Exchangers: Shell
Heat Exchangers: Tubes
Machining
Machining: Heat Exchanger
Materials Characterization
Materials: Qualified
Metal Fabrication
Metal Fabrication: Nickel & Nickel Alloy
Metal Fabrication: Stainless Steel
Metal Fabrication: Steel
Meters: Gas Flow
NDE Services
NDE Services: Radiographic Testing
Nondestructive Testing & Evaluation
Pressure Vessels
Radwaste Equipment
Radwaste Equipment: Low-Level
Radwaste Tanks
Retubing
Sludge Vessels
Tanks: Chemical
Tanks: Pressure
Tanks: Stainless Steel
Tanks: Storage
Welding
Welding: ASME Code
Welding: Automated



- **Western Chemical International Inc.,**
2939 N 67th Place, PO Box 22267, Scottsdale, AZ 85251; Phone: (480) 990-9487, Fax: (480) 946-6174, [Http://www.westernchem.com](http://www.westernchem.com), Email: wci@westernchem.com, Contact: Gary Conley.
(See advertisement on page 22)

Certified Nuclear Grade Equipment Cleaners
Cleaners: Electrical Equipment
Cleaners: Environmentally Safe Equipment
Cleaners: Mechanical Equipment
Consulting

- **Westinghouse Electric Company,**
P.O. Box 355, Pittsburgh, PA 15230; Phone: (412) 374-3373, Fax: (412) 374-3244, [Http://www.westinghouse-nuclear.com](http://www.westinghouse-nuclear.com), Email: fisch1ks@westinghouse.com, Contact: Karen Fischetti.
(See advertisements on pages 119)



- **WMG, Inc.,**
16 Bank St., Peekskill, NY 10566; Phone: (845) 667-2507, Fax: (914) 736-7170, [Http://www.wmginc.com](http://www.wmginc.com), Email: fsennyes@wmginc.com, Contact: Frank Sennyes.

Analysis: Criticality
Analysis: Dynamic
Analysis: Finite Element
Analysis: Neutron Activity
Analysis: Stress
Analysis: Structural
Analysis: Vibration
Analysis: Waste
Casks: Storage
Casks: Transport
Consulting: Decommissioning
Consulting: Nuclear
Consulting: Radiological
Consulting: Radwaste
Consulting: Regulatory Compliance
Consulting: Solid Waste Management
Consulting: Stress, Material
Consulting: Structural
Consulting: Waste Management
Containers: Radwaste
Decommissioning Services
Design: Structural
Engineering Services: BWR
Engineering Services: PWR
Engineering Services: Underwater
Engineering: Low-Level Waste Remediation
Engineering: Nuclear
Engineering: Radiological
Fuel Floor Support
Fuel Pool Cleanup
Fuel Pool Equipment
Fuel: Spent, Transport
Materials Characterization
Procedure Development: Site Specific
Project Management
Project Management: Underwater
Radiation Assessment
Radwaste Analysis
Radwaste Management Services
Radwaste Packaging
Reactor Head Removal Services
Shielding Analysis
Shielding Information: Nuclear
Software: Custom
Software: Radiological Data Management
Software: Waste Tracking
Staff Support: Engineering
Staff Support: Technical
Training: Radioactive Materials Handling
Training: Software
Training: Waste Management
Waste Analysis Systems
Waste Characterization
Waste Management Services

- **Wyle Laboratories, Inc.,**
7800 Hwy. 20 W, P.O. Box 07777, Huntsville, AL 35806; Phone: (256) 716-4315, Fax: 256/837-3363, [Http://www.wylelabs.com](http://www.wylelabs.com), Email: robert.francis@wylelabs.com, Contact: Robert L. Francis.

Actuators
Aging Management
Air Handling Units
Ammeters
Analysis: Dynamic
Analysis: Engineering
Analysis: Finite Element
Analysis: Material Identification
Analysis: Modal
Analysis: Reliability
Analysis: Root Cause
Analysis: Stress
Analysis: Vibration
Assemblies: Electrical
Blowers: Ventilation
Calibration Services
Calibration Systems
Centers: Electric Load
Chillers
Circuit Breaker Retrofitting
Circuit Breakers: Safety-Related
Commercial-Grade Dedication
Consulting
Contactors: Safety-Related
Contract Engineering Services
Control Cabinets
Control Panels: 1E
Control Panels: Safety-Related
Controllers: Flow
Controllers: Pressure
Controllers: Temperature
Converters: Safety-Related
Damper Operators
Dampers: Bubble Tight
Dampers: Control
Dampers: Electric
Dampers: High-Pressure
Dampers: Isolation
Dampers: Manual
Dampers: Pneumatic
Data Recorders: Seismic Qualified
Database Services: Part Availability
Destructive Testing
Diagnostic Systems
Diagnostics
Diagnostics: Valve
Diagnostics: Valve Actuator
Diesel Generators: Parts
Diesel Generators: Safety-Related
Distributor: OEM
Electrical Equipment Services
Engineering Services
Environmental Qualification
Equipment Design
Equipment Qualification
Equipment Replacement
Equipment: Mechanical
Equipment: Safety-Related
Failure Analysis
Fans: Axial
Fans: Centrifugal
Field Service
Flowmeters
Fuse Holders: Safety-Related
Fuses: Safety-Related
Gaskets: Radiation Resistant
Gauges: Force
Gauges: Pressure
Gauges: Vacuum
Heat Tracing Systems
Heaters: Electric
HVAC Systems
HVAC: Ventilation Equipment
Indicator Lights: Safety-Related
Indicators
Indicators: Panel Mounted
Information Services: Equipment Qualification
Instrument Power Supplies
Instrumentation: Seismic

Instrumentation: Vibration
 Instruments: Electronic
 Instruments: Safety-Related
 Instruments: Temperature Measuring
 Inverters
 Laboratory Services
 Licensing Support Services
 Life Extension
 Limit Switches Counters
 Logic System: Class 1E
 Maintenance Support
 Maintenance: Equipment
 Materials: Qualified
 Measurement Services
 Meters: Electrical
 Modifications
 Monitors: Temperature
 Motor Control Center Refurbishment
 Motor Control Centers: Safety-Related
 Motor Control Centers: Safety-Related Parts
 Motor Starters: Safety-Related
 Motors: Safety-Related
 Panels: Custom, Safety-Related
 Panels: Instrument
 Panels: Power Distribution, Safety-Related
 Panels: Safety-Related
 Parts Evaluation
 Parts: BWR Spare
 Parts: O.E.M.
 Parts: Procurement Assistance
 Parts: Replacement
 Parts: Replacement, Design
 Parts: Spare
 Penetrations: Electrical
 Pipe Snubbers
 Piping Design
 Power Supplies
 Power Supplies: Safety-Related
 Predictive Maintenance Systems: Electrical
 Procedure Development
 Procedure Development: Root Cause
 Qualification: Supplier
 R&D Services
 R&D: Fluid Mechanics
 Relays: Safety-Related

Resistance Temperature Detectors
 Sealing Systems: Quick-Disconnect
 Seismic Analysis
 Seismic Qualification
 Sensors
 Signal Conditioners
 Snubber Analysis
 Snubber Repair
 Snubber Testing
 Snubbers: Gauge
 Snubbers: Hydraulic
 Snubbers: Mechanical
 Snubbers: Pressure
 Solenoids
 Standards: Calibration
 Switches: Differential Pressure
 Switches: Flow
 Switches: Level
 Switches: Limit
 Switches: Pressure, Safety-Related
 Switches: Temperature, Safety-Related
 Switches: Thermocouple
 Switchgear
 Switchgear: Safety-Related
 Terminal Blocks
 Terminal Blocks: Safety-Related
 Test Loops
 Test Stands: Valve
 Testing
 Testing: Chemical
 Testing: Electrical
 Testing: Electrochemical
 Testing: Laboratory
 Testing: LOCA Conditions
 Testing: Mechanical
 Testing: Mechanical & Irradiation
 Testing: Metallurgical
 Testing: Overload Relay
 Testing: Resistivity
 Testing: Safety-Related Components
 Testing: Special
 Thermocouples
 Thermocouples: Safety-Related
 Training: Nuclear Equipment Maintenance
 Training: Nuclear Materials

Training: Seismic
 Training: Valves & Valve Actuators
 Transducers: Displacement
 Transducers: Safety-Related
 Transfer Switches: IE
 Transformers
 Transformers: Safety-Related
 Transmitters
 Transmitters: Diff. Press., Safety-Related
 Transmitters: Safety-Related
 Uninterruptible Power Supply: Safety-Related
 Valve Actuator
 Valve Analysis
 Valve Assemblies
 Valve Diagnostic Systems
 Valve Parts
 Valve Positioners
 Valve Testing
 Valves
 Valves: Gate
 Voltage Regulators: Safety-Related

Zetec, Inc.,
 8226 Bracken Place SE, Suite 100, Snoqualmie, WA
 98065; Phone: (425) 974-2700, Fax: (425) 974-2701,
 Http://www.zetec.com, Email: kchoi@zetec.com,
 Contact: Ki Choi.
(See advertisement on page 3)

Condenser Analysis/Inspection Services
 Data Acquisition Systems
 Data Management Systems
 Eddy Current Probes
 Eddy Current Test Equipment
 Eddy Current Test Standards
 Eddy Current Testing Services
 Robots and Robotic Equipment
 Software: Eddy Current Testing
 Staff Support: Nondestruction Examination
 Training: Eddy Current Testing
 Ultrasonic Inspection
 Ultrasonic Scanning
 Ultrasonic Test Equipment



2009 Call for Papers and Submittal Guidelines

Submit a one-page summary with the author's current biographical information (60 words) via e-mail or on company letterhead to initiate a submittal. Also provide the contact's e-mail address and phone number. See below for 2009 editorial schedule.

Nuclear Plant Journal

799 Roosevelt Road
 Building 6, Suite 208
 Glen Ellyn, IL 60137-5925 USA
 Phone: (630) 858-6161, extension 102
 Fax: (630) 858-8787
 E-mail: newal@goinfo.com
<http://www.NPJOnline.com>



Editorial Schedule

	Summary Due First Monday of	Complete Submittal Due Last Monday of
March-April	Plant Maintenance & Plant Life Extension	February
May-June.....	Outage Management & Health Physics	February
July-August	New Plants and Vendor Advertorial	April
September-October	Plant Maintenance & Advanced Reactors	April
January-February 2008	International Trade & Waste & Fuel Management	June
		June
		August
		August
		December
		December

Corporate Capabilities Participants

AAF International	90	Excelsior College	94	Reef Industries, Inc.	99
Advent Engineering Services, Inc	90	EXPONENT	94	Rigging International	100
Aerofin Corporation	90	Flowserve Flow Control Division	95	Sargent & Lundy	100
American Crane & Equipment Corp	90	Fuel Tank Maintenance Company LLC	95	Scientech	100
American DND Inc.	90	GE Hitachi Nuclear Energy	95	Sonic Systems International, Inc.	102
ANSALDO NUCLEARE SPA	90	General Atomics Electronic Systems, Inc.	95	Southern Testing Services	102
AREVA Inc.	90	General Cable (Brand-Rex)	96	Spectrum Technologies	102
Argo Turboserve Corporation (ATC)	90	Herguth Laboratories	96	SSM Industries, Inc.	102
AT&F Nuclear, Inc.	90	HI-Q Environmental Products Company	96	Stäubli Corporation	102
Atomic Energy of Canada Limited	91	IHI Southwest Technologies, Inc.	96	Studsvik, Inc	102
Babcock & Wilcox Canada	91	ILD, Inc.	96	T. D. Williamson, Inc.	102
Bartlett Holdings, Inc.	91	Kinectrics Incorporated	96	Talisman International, LLC ...	103
Bechtel Power	91	Laboratory Services	96	Tecnatom, S.A.	103
Bigge Power Constructors	91	Lights, Camera, Action LLC	96	The Delphi Groupe, Inc.	103
Biodex Medical Systems	92	LND, Inc.	97	The Shaw Group Inc.	103
Climax Portable Machine Tools, Inc.	92	Meggitt Safety Systems	97	Thermo Fisher Scientific	103
Container Products Corporation	92	Mirion Technologies	97	Thermo Scientific	103
Copes-Vulcan, An SPX Brand	92	MOTA Corporation	97	Thermo Scientific, Part of Thermo Fisher Scientific	103
CS-2 Inc.	92	Mott Corporation	98	Tioga Pipe Supply Company Inc.	103
CTR Technical Services, Inc.	92	Nuclear Shielding Supplies & Service, Inc.	98	TRANTER	103
Data Systems & Solutions SAS	93	NUCON International, Inc.	98	Underwater Construction Corpora- tion	104
Diversified Technologies Services, Inc.	93	O'Donnell Consulting Engineers, Inc.	98	UniStar Nuclear Energy	104
DIVESCO, Inc.	93	Pawling Engineered Products ...	98	UniTech Services Group, Inc. .	104
E.H. Wachs Co.	93	Penn Iron Works, Inc.	98	Uticom Systems Inc.	104
Enercon Services, Inc.	94	Power House Tool, Inc.	98	Valcor Engineering Corporation	104
Energy & Process Corporation	94	PPS Access Screening	98	Valtimet Inc.	104
Engine Systems, Inc.	94	Precision Custom Components, LLC	98	Velan Valve Corporation	104
		Proto-Power Corporation	99	Westerman Nuclear	105
		PTP Spent Fuel Services, LLC	99	Western Chemical International Inc.	105
		R. Brooks Associates, Inc.	99	Westinghouse Electric Company	105
		RCM Technologies, Inc.	99	WMG, Inc.	105
				Wyle Laboratories, Inc.	105
				Zetec, Inc.	106

Web Directory of Advertisers

- AAF
www.aafintl.com
- AECL CANDU Services
www.aecl.ca
- Aerofin Corporation
www.aerofin.com
- Alstom Power Systems
www.alstom.com
- American Crane & Equipment Corporation
www.americancrane.com
- American Tank & Fabricating
afnuclear.com
- ANSALDO NUCLEARE, Division of Ansaldo Energia SpA
<http://www.ansaldonucleare.it>
- AREVA NP, Inc.
www.areva-np.com/fuel
- Babcock & Wilcox Canada Ltd.
www.babcock.com/bwc
- Bigge Power Constructors
www.bigge.com
- Black & Veatch
www.bv.com
- Canberra Industries, Inc.
www.canberra.com
- Ceradyne
www.ceradyne.com
- Climax Portable Machine Tools, Inc.
www.cpm.com
- Copes-Vulcan
www.spxprocessequipment.com/
- Curtiss-Wright Flow Control Corporation
www.curtisswright.com
- Data Systems & Solutions
www.ds-s.com
- Day & Zimmermann Power Services
www.dayzim.com
- Divesco, Inc.
www.divesco.com
- EXCEL Services Corporation
<http://www.excelservices.com>
- Flowserve
flowserve.com
- Frontier Technology Corporation
<http://www.frontiertechcorp-cf252.com>
- G. D. Barri & Associates, Inc.
www.gdbarri.com
- GE Hitachi Nuclear Energy
www.gnf.com
- General Atomics-Electronic Systems, Inc.
www.ga-esi.com
- Hilman Rollers
www.hilmanrollers.com
- Hi-Q Environmental Products Company
www.HI-Q.net
- Holtec International
www.holtecinternational.com
- Joseph Oat Corporation
www.josephoat.com
- Kinectrics Inc.
www.kinectrics.com
- LND, Inc.
www.lndinc.com
- Ludlum Measurements, Inc.
www.ludlums.com
- Meggitt Safety Systems
www.meggittsafety.com
- Mirion Technologies, Inc.
www.mirion.com
- Mohawk Industrial & Nuclear Supply, Inc.
www.mohawksafety.com
- National Enrichment Facility
www.nefnm.com
- NPTS, Inc.
www.npts.net
- Nuclear Logistics Inc.
www.nuclearlogistics.com
- NUCON International
www.nucon-int.com
- Pawling Engineered Products
www.pawling.com
- Performance Contracting Inc. (PCI)
www.pcg.com
- Power House Tool, Inc.
www.powerhousetool.com
- Proto-Power Corporation
www.protopower.com
- Schulz Electric Company
www.schulzelectric.com
- Seal Master
www.sealmaster.com
- Siemens Power Generation
www.siemens.com/energy
- SSM Industries
www.ssmi.biz
- Studsvik, Inc.
www.studsvik.com
- Technology for Energy Corporation (TEC)
www.tec-usa.com
- tecnatom, s.a.
www.tecnatom.es
- The Shaw Group Inc., Nuclear Power Division
www.shawgrp.com
- Thermo Fisher Scientific, Scientific Instruments Division CIDTEC Cameras & Imagers
www.thermo.com/cidtec
- Tri Tool Inc.
www.tritool.com
- Trust Manufacturing
www.trustmfg.com
- Underwater Construction Corporation
www.uccdive.com
- UniStar Nuclear Energy
www.unistarnuclear.com
- UniTech Services Group
www.unitech.ws
- Urenco Enrichment Company Ltd.
www.urenco.com
- Westerman Nuclear
www.westermancompanies.com
- Western Chemical International Inc.
westernchem.com
- Westinghouse Electric Company LLC
www.westinghousenuclear.com
- WM Symposia, Inc.
www.wmsym.org
- WorleyParsons
www.worleyparsons.com
- Zetec, Inc.
www.zetec.com

Suppliers

• Denotes advertiser

§ Denotes Corporate Capabilities Participant

- § **AAF International**, P.O. Box 35690, Louisville, KY 40232-5690; Phone: (502) 637-0279, Fax: (502) 637-0141, Http://www.aafintl.com, Email: jmagner@aafintl.com, Contact: Joe Magner.
(See advertisement on page 44)
(See corporate capabilities on page 90)
- ABS Consulting**, 118 Portsmouth Avenue, Stratham, NH 03885; Phone: (603) 778-1144, Fax: (603) 778-7495, Http://www.absconsulting.com, Email: info@absconsulting.com, Contact: Paul Bruck.
- Acromag, Inc.**, 30765 S. Wixom Rd. P.O. Box 437, Wixom, MI 48393-7037; Phone: (248) 624-1541, Fax: (248) 624-9234, Http://www.acromag.com, Email: khaldenwanger@acromag.com, Contact: Karen Haldenwanger.
- Advanced Consulting Group, Inc.**, Executive Towers, 5901 N. Cicero Ave., Ste. 603, Chicago, IL 60646-5711; Phone: (773) 481-9500, Fax: (773) 481-9981, Email: advcnsgrp@aol.com, Contact: Thomas Litka.
- § **Advent Engineering Services, Inc.**, Domino's Farms, P.O. Box 555, Ann Arbor, MI 48106; Phone: (734) 930-7500, Fax: (734) 327-7501, Http://www.adventengineering.com, Email: dcw@adventengineering.com, Contact: Douglas Wood.
(See corporate capabilities on page 90)
- § **Aerofin Corporation**, 4621 Murray Pl., Lynchburg, VA 24502; Phone: (434) 845-7081, Fax: (434) 528-6281, Http://www.aerofin.com, Email: belliot@aerofin.com, Contact: Brian Elliott.
(See advertisement on page 48)
(See corporate capabilities on page 90)
- Air Liquide America Specialty Gases, LLC**, 6141 Easton Rd., P.O. Box 310, Plumsteadville, PA 18949-0310; Phone: (215) 766-8860, Fax: (215) 766-2476, Http://www.scottgas.com, www.airliquide.com, Email: markreq@scottgas.com, Contact: Robert Jefferys.
- Air Monitor Corp.**, 1050 Hopper Avenue, Santa Rosa, CA 95403; Phone: (707) 521-1703, Fax: (707) 526-2825, Http://www.airmonitor.com, Email: pmiyaoka@airmonitor.com, Contact: Pat Miyaoka.
- Alexander Vacuum Research, Inc.**, 16 Butternut St., P.O. Box 589, Greenfield, MA 01302-0589; Phone: (413) 498-9924, Fax: (413) 498-9926, Contact: Ronald Aleman.
- ALFAB, Inc.**, 220 Boll Weevil Circle, P.O. Box 311327, Enterprise, AL 36330; Phone: (334) 347-9516, Fax: (334) 393-4864, Http://www.alfabinc.com, Email: nbrown@alfabinc.com, Contact: Neal Brown.
- **Alstom Power**, 3 Avenue Andre Malraux, Paris 92309, France; Phone: (+33) 1 41492722, Http://www.alstom.com, Email: susanne.shields@alstom.com, Contact: Susanne Shields.
(See advertisement on page 85)
- AMEC NSS Limited AMEC NCL**, 700 University Ave., 4th Floor, Toronto M5G 1X6, Ontario Canada; Phone: (416) 592-7000, Fax: (416) 592-8284, Http://www.amecnss.com, Email: walter.thompson@amec.com, Contact: Walter Thompson.
- American Airworks**, 578 Robert C Byrd Dr., P.O. Box 1000, Sophia, WV 25921-1000; Phone: (800) 523-7222, Fax: (304) 683-3257, Http://www.americanairworks.com, Email: sales@americanairworks.com, Contact: Ray Lambert.
- § **American Crane & Equipment Corp.**, 531 Old Swede Rd., Douglassville, PA 19518; Phone: (610) 385-6061 ext 224, Fax: (610) 385-3191, Http://www.americancrane.com, Email: sales@americancrane.com, Contact: Karen Norheim.
(See advertisement on page 33)
(See corporate capabilities on page 90)
- § **American DND Inc.**, P.O. Box 553, Grand Island, NY 14072; Phone: (866) 699-5515, Fax: (716) 773-5515, Http://www.AmericanDND.com, Email: ADND@AmericanDND.com, Contact: Bill Schaab.
(See corporate capabilities on page 90)
- American Stress Technologies**, 840 Watercrest Way, Cheswick, PA 15024; Phone: 724/410-1030, Fax: 724/410-1031, Http://www.astresstech.com, Email: info@astresstech.com, Contact: Robert Ehrman.
- American Triex, Inc.**, 718 Schoolhouse Rd., Sobieski, WI 54171; Phone: (920) 822-8340, Email: jrnuelle@amtriex.com, Contact: Dr. J. Robert Mueller.
- American Warming & Ventilating**, 7301 International Dr., Holland, OH 43528; Phone: (419) 865-5000, Fax: (419) 865-1374, Http://www.awv.com, Email: jboutwell@awv.com, Contact: James R Boutwell.
- AMETEK Programmable Power Supporting Elgar Nuclear Equip.**, 9250 Brown Deer Rd., San Diego, CA 92121; Phone: (858) 458-0245, Fax: (858) 458-0267, Http://www.Ametek.com, Email: don.dattilo@Ametek.com, Contact: Donald P. Dattilo.
- § **ANSALDO NUCLEARE SPA**, Corso Perrone, 25, Genova, 16152 Italy; Phone: +39 0106558212, Fax: +39 010 655 8415, Http://www.ansaldonucleare.it, Email: umberto.minopoli@ann.ansaldo.it, Contact: Umberto Minopoli.
(See advertisement on page 67)
(See corporate capabilities on page 90)
- Apantec LLC**, 4500 North Cannon Avenue, Lansdale, PA 19446; Phone: (215) 362-5340, Fax: 215/362-5343, Http://www.apantec.com, Email: tomalley@apantec.com, Contact: Thomas E. O' Malley.
- Apco Extruders Inc.**, P.O. Box 556, 180 National Rd., Edison, NJ 08818; Phone: (732) 287-3000, Fax: (732) 287-1421, Email: apcoext@aol.com, Contact: Charlie Grand.
- Applied Consultants, Inc.**, 1501 Main St., Ste. 40, Tewksbury, MA 01876; Phone: (978) 851-0933, Fax: (978) 851-0932, Http://www.appcons.com, Email: AppCons@verizon.net, Contact: Joseph Lischinsky.
- Arch Wood Protection**, 1955 Lake Park Dr., Suite 100, Smyrna, GA 30080; Phone: 770/805-3215, Fax: 866/873-3789, Http://www.drican.com, Email: CDDEVENZIO@archchemicals.com, Contact: Huck DeVenzio.
- Arch Wood Protection, Inc.**, 1955 Lake Park Drive, Suite 100, Smyrna, GA 30080; Phone: (770) 801-6600, Fax: (770) 801-1990, Http://www.wolmanizedwood.com, Email: ptwinfo@archchemicals.com, Contact: Huck DeVenzio.
- § **AREVA Inc. AREVA NC Inc.**, 4800 Hampden Lane, Suite 1100, Bethesda, MD 20814-3416; Phone: (301) 841-1600, Http://www.us.aveva.com, Email: cassie.hagan@aveva.com, Contact: Cassie Hagan.
(See advertisement on page 2)
(See corporate capabilities on page 90)
- § **Argo Turboserve Corporation (ATC)**, Citiview Corporate Center, 160 Chubb Avenue, Lyndhurst, NJ 07071; Phone: (201) 964-4153, Fax: (201) 507-1045, Http://www.argoturbo.com, Email: dtenzer@argoturbo.com, Contact: Daniel Tenzer.
(See corporate capabilities on page 90)
- Argonne National Laboratory**, 9700 S. Cass Avenue/Bldg 208, Argonne, IL 60439; Phone: (630) 252-6729, Fax: (630) 252-7577, Http://www.dd.anl.gov, Email: lboing@anl.gov, Contact: Lawrence E Boing.
- Associated Technologies**, 610 N. Bicycle Path, Suite 7, Port Jefferson Station, NY 11776; Phone: (631) 331-2323, Fax: (631) 331-2382, Email: info@assocetek.comt, Contact: David Estabrook.
- § **AT&F Nuclear, Inc Division of American Tank and Fabricating**, 12314 Elmwood Ave. NW, Cleveland, OH 44111; Phone: (800) 544-5316, Fax: (216) 252-4963, Http://www.amtank.com, Email: cantrellk@amtank.com, moscardinir@amtank.com, Contact: Kevin Cantrell.
(See advertisement on page 14)
(See corporate capabilities on page 90)
- ATI Allvac**, 2020 Ashcraft Ave., P.O. Box 5030, Monroe, NC 28110-5030; Phone: (704) 289-4511, Fax: (704) 289-4018, Http://www.allvac.com, Email: howard.freese@allvac.com, Contact: Howard L. Freese.
- ATI Wah Chang**, P.O. Box 460, Albany, OR 97321; Phone: (541) 926-4211 ext 6914, Fax: (541) 967-6994, Http://www.wahchang.com, Email: custserv@wahchang.com, Contact: Stephanie O'Connor.
- Atlantic Nuclear Services Ltd.**, 125 Hanwell Rd., P.O. Box 1268, Fredericton E3B 5C8, New Brunswick Canada; Phone: (506) 458-9552, Fax: (506) 451-0525, Http://www.anl.ca, Email: kscott@anl.ca, Contact: Keith Scott.

- § **Atomic Energy of Canada Limited**, AECL-Sheridan Park, 2251 Speakman Dr., Mississauga L5K 1B2, Ontario Canada; Phone: (905) 823-9060, X7541, Fax: (905) 403-7565, [Http://www.aecl.ca](http://www.aecl.ca), Email: smithh@aecl.ca, Contact: Heather Smith. (See advertisement on page 11) (See corporate capabilities on page 91)

Attenuation Environmental Company, P.O. Box 30537, Seattle, WA 98113; Phone: (206) 783-3208, Fax: (206) 783-3989, [Http://www.attenuation.us.com](http://www.attenuation.us.com), Email: doris@attenuation.us.com, Contact: Doris A. Minor.
- § **Babcock & Wilcox Canada**, 581 Coronation Blvd., Cambridge N1R 5V3, Ontario Canada; Phone: (519) 621-2130, Fax: (519) 622-3665, [Http://www.babcock.com](http://www.babcock.com), Email: jtang@babcock.com, Contact: Jun Tang. (See advertisement on page 81) (See corporate capabilities on page 91)
- § **Bartlett Holdings, Inc.**, 60 Industrial Park Rd., Plymouth, MA 02360; Phone: (508) 591-1149, Fax: (508) 746-3113, [Http://www.bartlettinc.com](http://www.bartlettinc.com), Email: lauren@bartlettinc.com, Contact: Lauren Buckman. (See corporate capabilities on page 91)
- § **Bechtel Power**, 5275 Westview Drive, Frederick, MD 21703-8306; Phone: 301/228-8360, Fax: 301/696-0673, [Http://www.bechtel.com](http://www.bechtel.com), Email: afiorent@bechtel.com, Contact: Alan Fiorente. (See corporate capabilities on page 91)

Berkeley Nucleonics Corp., 2955 Kerner Blvd., San Rafael, CA 94901-5418; Phone: (415) 453-9955, Fax: (415) 453-9956, [Http://www.berkeleynucleonics.com](http://www.berkeleynucleonics.com), Email: info@berkeleynucleonics.com, Contact: Eiaine Brello Murphy.
- Biach Industries, Inc.**, 75 Chestnut St., Cranford, NJ 07016; Phone: (908) 276-3110, Fax: (908) 276-0815, [Http://www.biach.com](http://www.biach.com), Email: richardh@biach.com, Contact: Richard Hill.
- § **Bigge Power Constructors**, 10700 Bigge Ave., San Leandro, CA 94577; Phone: (510) 638-8100, Fax: (510) 639-4053, [Http://www.bigge.com](http://www.bigge.com), Email: gknopf@bigge.com, Contact: Gedge Knopf. (See advertisement on page 6) (See corporate capabilities on page 91)
- § **Biodex Medical Systems**, 20 Ramsay Rd., Shirley, NY 11967; Phone: (800) 224-6339, Fax: (631) 205-2413, [Http://www.biodex.com](http://www.biodex.com), Email: info@biodex.com, Contact: Lila Corwin. (See corporate capabilities on page 92)

Birns, Inc., 1720 Fiske Place, P.O. Box 909, Oxnard, CA 93033; Phone: (805)487-5393, Fax: (805)487-0427, [Http://www.birns.com](http://www.birns.com), Email: service@birns.com, Contact: Eric Birns.
- **Black & Veatch**, 11401 Lamar Ave., Overland Park, KS 66211; Phone: (913) 458-2491, Fax: (913) 458-2491, [Http://www.bv.com](http://www.bv.com), Email: vollenweiderD@bv.com, Contact: Doug Vollenweider. (See advertisement on page 25)

Blue Lake Products, P.O. Box 16355, Irvine, CA 92623-6355; Phone: 949/786-0108, Fax: 949/786-3108, [Http://www.bluelakeproducts.com](http://www.bluelakeproducts.com), Email: dean@bluelakeproducts.com, Contact: Dean Smeaton.
- Bluegrass Concrete Cutting, Inc.**, 107 Mildred St., P.O. Box 427, Greenville, AL 36037; Phone: (800) 734-2935, Fax: (334) 382-0815, [Http://www.concretecutters.com](http://www.concretecutters.com), Email: lmullen@concretecutters.com, Contact: Lisa K. Mullen.
- Bohler Bleche Sheet & Plate Affl. of Bohler Blech GmbH, Murzzuschlag, Austria**, 11525 Brittmoores Park Dr., Houston, TX 77041; Phone: 713-856-5452, Fax: (713) 856-5458, [Http://www.bohler-bleche.at](http://www.bohler-bleche.at), Email: John-BBG@swbell.net, Contact: John Leonard.
- British Shielding Windows Ltd., St. Asaph Business Park, Unit 16, St. Asaph, Denbighshire LL17 OLJ, UK**; Phone: 44 1745 536730, Fax: 44 1745 536735, [Http://www.bswin.com](http://www.bswin.com), Email: sales@bswin.com, Contact: Philip Goodwill.
- Burns and Roe**, 800 Kinderkamack Road, Oradell, NJ 07649; Phone: (201) 265-2000, Fax: (201) 986-4335, [Http://www.roe.com](http://www.roe.com), Email: edavis@roe.com, Contact: Bart Roe.
- BW/IP International, Inc.**, 2300 E. Vernon Avenue, Los Angeles, CA 90058; Phone: (213)587-6171, Fax: (213)587-8668, Contact: William A. Klenner.
- C.J. Enterprises Inc. Div. of C.J. Instruments, Inc.**, P.O. Box 570430, Tazana, CA 91357; Phone: (818) 996-4131, Fax: (818) 708-8473, Email: cjinstruments@aol.com, Contact: Marshall Cantor.
- **Canberra Industries, Inc.**, 800 Research Pkwy., Meriden, CT 06450; Phone: (203) 238-2351 x2148, Fax: (203) 235-1347, [Http://www.canberra.com](http://www.canberra.com), Email: tpat-tison@canberra.com, Contact: Tammy Pattison. (See advertisement on page 13)

Carpenter Technology Corp., P.O. Box 14462, Reading, PA 19612-4662; Phone: (610) 208-2000, Fax: (610) 208-2097, [Http://www.carttech.com](http://www.carttech.com), Email: service@cartech.com, Contact: Lisa MacGregor.
- CC Technologies, Inc. A DNV Company**, 5777 Frantz Rd., Dublin, OH 43017; Phone: 614/761-6962, Fax: 614/761-1633, [Http://www.cctechnologies.com](http://www.cctechnologies.com), Email: cctechnologiesr@dnv.com, Contact: Colleen Stoker.
- Central Wire**, 1552 Caskey Road, Lancaster, SC 29720; Phone: (803) 283-3353, Fax: (803) 283-6303, [Http://www.techalloy.com](http://www.techalloy.com), Email: jrobinson@centralwire.com, Contact: John Robinson.
- **Ceradyne Boron Products, LLC**, 3169 REd Hill Ave, Costa Mesa, CA 92626; Phone: (714) 675-6565, Fax: (714) 384-9484, [Http://www.ceradyne.com](http://www.ceradyne.com), Email: pbass@ceradyne.com, Contact: Patti Bass. (See advertisement on page 63)
- § **Climax Portable Machine Tools, Inc.**, 2712 E. 2nd St., Newberg, OR 97132; Phone: 800-333-8311, Fax: 856-374-0767, [Http://www.cpm.com](http://www.cpm.com), Email: info@cpmt.com, Contact: Steve Muhr. (See advertisement on page 57) (See corporate capabilities on page 92)
- Coastal Network, Inc.**, 600 Plantation Ct., Charlottesville, VA 22903-7657; Phone: (434) 978-1204, Fax: (434) 978-4775, [Http://www.nuclearsupply.com](http://www.nuclearsupply.com), Email: coanetinc@aol.com, Contact: Michael Moyles.
- Collier Associates, Inc.**, 235 Ridgewood Drive, Mystic, CT 06355-2029; Phone: (860)536-9538, Fax: (860)572-8439, [Http://http://www.gwcollier.com](http://http://www.gwcollier.com), Email: cai@gwcollier.com, Contact: George W. Collier.
- Conger & Elsea, Inc.**, 9870 Hwy. 92, Ste. 300, Woodstock, GA 30188; Phone: (800) 875-8709, Fax: (770) 926-8305, [Http://www.conger-elsea.com](http://www.conger-elsea.com), Email: dorian.congerd@conger-elsea.com, Contact: Dorian Conger.
- § **Container Products Corporation**, 112 N. College Rd., P.O. Box 3767, Wilmington, NC 28405; Phone: 910/392-6100, Fax: 910/392-6778, [Http://www.c-p-c.com](http://www.c-p-c.com), Email: hjksales@c-p-c.com, Contact: H. Jeffrey Kahle. (See corporate capabilities on page 92)

Conval Inc., 265 Field Rd., Somers, CT 06071; Phone: (860) 763-3551, Fax: (860) 763-3557, [Http://www.conval.com](http://www.conval.com), Email: mhendrick@conval.com, Contact: Michael Hendrick.
- § **Copes-Vulcan, An SPX Brand**, 5620 West Road, McKean, PA 16426; Phone: (814) 476-5800, Fax: (814) 476-5848, [Http://www.copesvulcan.com](http://www.copesvulcan.com), Email: cv@spx.com, Contact: Courtney Butzine. (See advertisement on page 87) (See corporate capabilities on page 92)

Croll-Reynolds Engineering Company Inc., 2400 Reservoir Ave., Trumbull, CT 06611-4735; Phone: (203) 371-1983, Fax: (203) 371-0615, [Http://www.croll-reynolds-engineering.com](http://www.croll-reynolds-engineering.com), Email: creco@att.net, Contact: L.D. Ancillai.
- § **CS-2 Inc.**, P.O. Box 553, Grand Island, NY 14072; Phone: (866) 699-5515, Fax: (716) 773-5515, [Http://www.cscs-i.com](http://www.cscs-i.com), Email: CS2@cscs-icom, Contact: Bill Schaab. (See corporate capabilities on page 92)
- § **CTR Technical Services, Inc.**, 950 Sugarloaf Rd., Manitou Springs, CO 80829; Phone: (800) 524-9328, Fax: (719) 685-3579, [Http://www.ctr-tech.com](http://www.ctr-tech.com), Email: ctr@ctr-tech.com, Contact: Charles T. Rom-bough. (See corporate capabilities on page 92)
- **Curtiss-Wright Flow Control Corporation**, 2950 Birth Street, Brea, CA 92821; Phone: (714) 528-2301, x240, Fax: (714) 528-0128, [Http://www.curtisswright.com](http://www.curtisswright.com), Email: acorkhill@curtisswright.com, Contact: Arlene Corkhill. (See advertisement on page 120)

Cutting Edge Services Corporation, 1535 Old SR 74, Batavia, OH 45103; Phone: (513) 388-0199, Fax: (513)732-1248, [Http://www.cuttingedgeservices.com](http://www.cuttingedgeservices.com), Email: beckman@cuttingedgeservices.com, Contact: Timothy Beckman.
- Cygnus Instruments Inc.**, 1993 Moreland Pkwy.Ste. 202, P.O. Bow 6417, Annapolis, MD 21401; Phone: (410) 267-9771, Fax: (410) 268-2013, [Http://www.cygnusinstruments.com](http://www.cygnusinstruments.com), Email: sales@cygnusinstruments.com, Contact: Rod Sanders.
- § **Data Systems & Solutions SAS**, 23 Chemin Du Vieux Chene 38246, Meylan Cedex 9, F38240 France; Phone: (33) (0) 4-76-61-15-00, [Http://www.ds-s.com](http://www.ds-s.com), Email: desgeorge@DS-S.com, Contact: Romain Desgeorge. (See advertisement on page 15) (See corporate capabilities on page 93)

- **Day & Zimmermann Power Services**, 1500 Spring Garden St 10th Floor, Philadelphia, PA 19130; Phone: 215/299-4924, Fax: 215/299-8395, [Http://www.dznps.com](http://www.dznps.com), Email: david.bronczyk@dayzim.com, Contact: David A. Bronczyk. (See advertisement on page 59)
- Delta M Corporation**, 1003 Larsen Dr., Oak Ridge, TN 37830; Phone: 865/483-1569 ext115, Fax: 865/483-1142, [Http://www.deltamcorp.com](http://www.deltamcorp.com), Email: tsmith@deltamcorp.com, Contact: A. D. White.
- Design Assistance Corporation**, 5 Gilchrist Drive, P.O. Box 215, Swedesboro, NJ 08085; Phone: (800) 662-5877, Fax: (856) 241-9545, [Http://www.dac-3d.com](http://www.dac-3d.com), Email: sales@dac-3d.com, Contact: Glenn Woerner.
- Design Engineering Analysis Corporation**, 335 Morganza Rd., Canonsburg, PA 15317; Phone: (724) 743-3322, Fax: (724) 743-0934, [Http://www.deac.com](http://www.deac.com), Email: info@deac.com, Contact: George J. Hrico.
- § **Diversified Technologies Services, Inc.**, 2680 Westcott Boulevard, Knoxville, TN 37931; Phone: (865) 539-9000, Fax: (865) 539-9001, [Http://www.dts9000.com](http://www.dts9000.com), Email: info@dts9000.com, Contact: Charles Jensen. (See corporate capabilities on page 93)
- § **DIVESCO, Inc.**, 5000 Hwy. 80 E, Jackson, MS 39208; Phone: (601) 932-1934, Fax: (601) 932-5698, [Http://www.divesco.com](http://www.divesco.com), Email: kay@divesco.com, Contact: S.Kay Fisher. (See advertisement on page 64) (See corporate capabilities on page 93)
- Draeger Safety, Inc.**, 101 Technology Technology Dr., Pittsburgh, PA 15275; Phone: 412/787-8383, Fax: 412/787-2207, [Http://www.draeger.com](http://www.draeger.com), Email: prodinfo@draeger.com, Contact: Shelli Cosmides.
- § **E.H. Wachs Co.**, 600 Knightsbridge Pkwy., Lincolnshire, IL 60069; Phone: 800-323-8185, Fax: 847-520-1147, [Http://www.wachso.com](http://www.wachso.com), Email: sgilmore@wachso.com, Contact: Sherry Gilmore. (See corporate capabilities on page 93)
- Eberline Services Inc.**, 7021 Pan American Freeway NE, Albuquerque, NM 87109; Phone: (505) 262-2694, Fax: (505) 262-2698, [Http://www.eberlineservices.com](http://www.eberlineservices.com), Email: vybarra@eberlineservices.com, Contact: Veronica Ybarra.
- Elan Technical Corporation**, 35 Kings Hwy. E, Fairfield, CT 06825; Phone: (203) 335-2115, Fax: (203) 335-2723, [Http://www.elantechnical.com](http://www.elantechnical.com), Email: rb/etc@usa.net, Contact: Randolph Bush.
- Emerson Process Management**, 301 South L 35 Ave., Marshalltown, IA 50158; Phone: (641) 754-3288, Fax: (641) 754-2731, [Http://www.fisher.com](http://www.fisher.com), Email: john.wells@emersonprocess.com, Contact: John Wells.
- § **Enercon Services, Inc.**, 500 Town Park Lane, Kennesaw, GA 30144; Phone: (770) 919-1930, Fax: (770) 919-1932, [Http://www.enercon.com](http://www.enercon.com), Email: awoods@enercon.com, Contact: Arther Woods. (See corporate capabilities on page 94)
- § **Energy & Process Corporation**, 2146-B Flintstone Dr., P.O. Box 125, Tucker, GA 30084; Phone: (770) 934-3101, Fax: (770) 938-8903, [Http://www.energyandprocess.com](http://www.energyandprocess.com), Email: mark.capallo@energyandprocess.com, Contact: Mark Capallo. (See corporate capabilities on page 94)
- Energy Resources Group, Inc.**, 23 Commerce Park Way, Farmington, NH 03835; Phone: (603) 355-2535, Fax: (603) 355-2539, Email: ergincorp@aol.com, Contact: A.J. Maggio.
- Enertech**, 2950 Birch St., Brea, CA 92621; Phone: (714) 528-2301x240, Fax: (714) 528-0128, [Http://www.enertechnuclear.com](http://www.enertechnuclear.com), Email: email@curtisswright.com, Contact: Arlene Corkhill.
- § **Engine Systems, Inc.**, 175 Freight Road, Rocky Mount, NC 27804; Phone: (252) 977-2720, Fax: (252) 446-3830, [Http://www.enginesys.com/](http://www.enginesys.com/), Email: michael.thiel@kirbycorp.com, Contact: Michael Thiel. (See corporate capabilities on page 94)
- ENMET Corporation**, 680 Fairfield Court, P.O. Box 979, Ann Arbor, MI 48106; Phone: (734) 761-1270, Fax: (734) 761-3220, [Http://www.enmet.com](http://www.enmet.com), Email: info@enmet.com, Contact: Nancy Aulisa.
- Epicor, Inc.**, 1414 East Linden Ave., P.O. Box 1608, Linden, NJ 07036; Phone: (908) 925-0800, Fax: (908) 925-7795, Email: epicorinc@aol.com, Contact: Rose Bussiculo.
- Euclid Garment Manufacturing Company**, 333 Martinel Dr. P.O. Box 550, Kent, OH 44240-0550; Phone: (330) 673-7413, Fax: (330) 673-0228, [Http://www.euclidgarment.com](http://www.euclidgarment.com), Email: hflfleischmann@euclidgarment.com, Contact: Howard Fleischmann.
- **EXCEL Services Corporation**, 11921 Rockville Pike, Ste. 100, Rockville, MD 20852; Phone: (301) 984-4400, Fax: (301) 984-7600, [Http://www.excelservices.com](http://www.excelservices.com), Email: donaldh@excelservices.com, Contact: Donald Hoffman. (See advertisement on page 18-19)
- § **Excelsior College**, 7 Columbia Circle, Albany, NY 12182; Phone: (518) 464-8665, Fax: (518) 464-8777, [Http://www.excelsior.edu](http://www.excelsior.edu), Email: atraver@excelsior.edu, Contact: Adam Traver. (See corporate capabilities on page 94)
- § **EXPONENT**, 149 Commonwealth Dr., Menlo Park, CA 94025; Phone: (888) 656-3976 (EXPO), Fax: (650) 688-7231, [Http://www.exponent.com](http://www.exponent.com), Email: info@exponent.com, Contact: Joseph Famigletti. (See corporate capabilities on page 94)
- § **Flowserve Flow Control Division**, 1900 South Saunders Street, Raleigh, NC 27603; Phone: (919) 831-3200, Fax: (919) 831-3317, [Http://www.flowserve.com](http://www.flowserve.com), Email: fbensing@flowserve.com, Contact: Floyd Bensing. (See corporate capabilities on page 95)
- **Flowserve Pump Division**, 2300 E. Vernon Ave., Vernon, CA 90058; Phone: 323-584-1886, Fax: 323-586-4137, [Http://flowserve.com](http://flowserve.com), Email: fgrondhuis@flowserve.com, Contact: Fred Grondhuis. (See advertisement on page 68-69)
- Fortum Nuclear Services Ltd.**, Keilaniementie 1, Espoo, P.O. Box 100, 00048 Fortum, Finland; Phone: +358 10 45 32416, Fax: +358 10 45 32525, [Http://www.fortum.com](http://www.fortum.com), Email: jorma.kotro@fortum.com, Contact: Jorma Kotro.
- **Frontier Technology Corporation**, 1641 Burnett Dr., Xenia, OH 45385; Phone: (937) 376-5691, Fax: (937) 376-5692, [Http://www.frontiertechcorp-cf252.com](http://www.frontiertechcorp-cf252.com), Email: treva@juno.com, Contact: Treva Janzow. (See advertisement on page 78)
- § **Fuel Tank Maintenance Company LLC**, 240 Mill Dr, Cookeville, TN 38501; Phone: (931) 528-1137, Fax: (931) 520-3862, [Http://www.fueltankmaintenance.com](http://www.fueltankmaintenance.com), Email: jthahnjr@hotmail.com, Contact: Jerry T. Hahn. (See corporate capabilities on page 95)
- **G.D. Barri & Associates, Inc.**, 6860 W. Peoria Ave., Peoria, AZ 85345; Phone: (623) 773-4010, Fax: (623) 773-2924, [Http://www.gdbarri.com](http://www.gdbarri.com), Email: georgia.barri@gdbarri.com, Contact: Georgia C. Barri. (See advertisement on page 79)
- Gamma Products, Inc.**, P.O. Box 190, Palos Park, IL 60464-0190; Phone: (708) 974-4100, Fax: (708) 974-0071, [Http://www.gammaproducts.com](http://www.gammaproducts.com), Email: sales@gammaproducts.com, Contact: Walter Meier.
- § **GE Hitachi Nuclear Energy**, 3901 Castle Hayne Rd., PO Box 780 M/C J32, Wilmington, NC 28402; Phone: (910) 675-6689, [Http://www.ge-energy.com/nuclear](http://www.ge-energy.com/nuclear), Email: Christa.Miller@ge.com, Contact: Christa G Miller. (See advertisement on page 9) (See corporate capabilities on page 95)
- § **General Atomic Electronic Systems, Inc.**, 4949 Greencraig Ln., San Diego, CA 92123; Phone: (858) 522-8352, Fax: (858) 522-8318, [Http://www.ga-esi.com](http://www.ga-esi.com), Email: phil.newman@ga-esi.com, Contact: Phil Newman. (See advertisement on page 37) (See corporate capabilities on page 95)
- § **General Cable (Brand-Rex)**, 1600 W. Main St., Willimantic, CT 06226-1128; Phone: (860) 465-8712, Fax: (860) 465-8869, [Http://www.GeneralCable.com](http://www.GeneralCable.com), Email: gliskom@GeneralCable.com, Contact: Gerald R. Liskom. (See corporate capabilities on page 96)
- Health Physics Association**, 3334 Commercial Ave., Northbrook, IL 60062-1909; Phone: (708) 480-1900, Contact: Theodore Fields.
- HellermannTyton**, 7930 N. Faulkner Rd., Milwaukee, WI 53224; Phone: (800) 822-4352, Fax: (414) 355-7341, [Http://www.hellermann.tyton.com](http://www.hellermann.tyton.com), Email: corp@htamericas.com, Contact: Michelle Pigsley.
- Hennigan Engineering Company, Inc.**, 55 Industrial Park Rd., Hingham, MA 02043; Phone: (800) 472-8484, Fax: (781) 740-8738, [Http://www.henniganengineering.com](http://www.henniganengineering.com), Email: power@henniganengineering.com, Contact: Timothy Hennigan, Jr.
- Henry Pratt Company**, Sub. of Mueller Co., 401 S. Highland Ave., Aurora, IL 60506; Phone: (630) 844-4070, Fax: (630) 844-4160, [Http://www.henrypratt.com](http://www.henrypratt.com), Email: ileblanc@henrypratt.com, Contact: Sky LeBlanc.
- Herculite Products**, P.O. Box 435, Emigsville, PA 17318; Phone: (717) 764-1192, Fax: (717) 764-5211, [Http://www.herculite.com](http://www.herculite.com), Contact: Customer Service.
- § **Herguth Laboratories**, 101 Corporate Pl., Vallejo, CA 94590; Phone: (800) 645-5227, Fax: (707) 554-0109, [Http://www.herguth.com](http://www.herguth.com), Email: lperry@herguth.com, Contact: Linda Perry. (See corporate capabilities on page 96)
- **Hilman Inc.**, 12 Timber Ln., Marlboro, NJ 07746; Phone: (732) 462-6277, Fax: (732) 462-6355, [Http://www.hilmanrollers.com](http://www.hilmanrollers.com), Email: jhill@hilmanrollers.com, Contact: Jeff Hill. (See advertisement on page 58)

- § **HI-Q Environmental Products Company**, 7386 Trade St., San Diego, CA 92121; Phone: (858) 549-2820, Fax: (858) 549-9657, Http://www.HI-Q.net, Email: info@HI-Q.net, Contact: Marc Held. (See advertisement on page 10) (See corporate capabilities on page 96)
- **Holtec International**, 555 Lincoln Dr. W, Marlton, NJ 08053; Phone: (856) 797-0900, X655, Fax: (856) 797-0909, Http://www.holtecinternational.com, Email: joy_russell@holtec.com, Contact: Joy Russell. (See advertisement on page 21)
- Homeland-Defense 4 U, Inc.**, P.O. Box 581, St. Louis, MO 63006; Phone: (314) 727-5252, Fax: 636/536-2234, Http://www.homeland-defense4u.com, Email: ann@homeland-defense4u.com, Contact: Ann Morrison.
- Howden UK Ltd**, Old Govan Rd., Renfrew, Scotland PA4 8XJ, United Kingdom; Phone: 44 141 885 7300, Fax: 44 141 885 7445, Http://www.howden.com, Email: alan.rough@howden.com, Contact: Alan Rough.
- Human and Organizational Performance Improvement**, 7030 North 175th Avenue, Waddell, AZ 85355; Phone: (602) 908-0684, Email: hopiconsulting@msn.com, Contact: Michael Salazar.
- Hydratight**, 5001 Moundview Dr., Red Wing, MN 55066; Phone: (651) 388-8661, Fax: (651) 388-0002, Http://www.hydratight.com, Email: redwing@hydratight.com, Contact: Brian Ahrens.
- ICM - International Climbing Machines**, 630 Elmira Rd, Ithica, NY 14850; Phone: (607) 288-4001, Fax: (607) 288-4004, Http://www.icm.cc, Email: info@icm.cc, Contact: Sam Maggio.
- § **IHI Southwest Technologies, Inc.**, 6766 Culebra Rd., San Antonio, TX 78238; Phone: (210) 256-4107, Fax: (210) 521-2311, Http://www.ihiswt.com, Email: stodd@ihiswt.com, Contact: Steve Todd. (See corporate capabilities on page 96)
- § **ILD, Inc.**, 8867 Highland Rd., #378, Baton Rouge, LA 70808; Phone: (225) 769-2780, Fax: (225) 769-2751, Http://www.ildpower.com, Email: jack@ildpower.com, Contact: Jack Little. (See corporate capabilities on page 96)
- IMI Components Ltd.**, Nobel Way, Witton, Birmingham B6 7ES, United Kingdom; Phone: 44 121 344 5800, Fax: 44 121 344 3056, Http://www.imicomponents.com, Email: carl.robinson@imicomponents.com, Contact: Carl N. Robinson.
- Infosight Corp.**, 20700 US.Hwy. 23, P.O. Box 5000, Chillicothe, OH 45601; Phone: 740/642-3600 888/642-3600, Fax: 740/642-5001, Http://www.infosight.com, Email: sales@infosight.com, Contact: Rebecca J Dolan.
- Interdevelopment, Inc.**, P.O. Box 15249, Arlington, VA 22215; Phone: (202) 508-1459, Fax: (202) 337-3159, Http://www.interdevelopment.com, Email: interdevelopment@starpower.net, Contact: Margareta. K. Luddemann-Faris.
- International Quality Consultants, Inc.**, 106 Freepoint Rd., Butler, PA 16002; Phone: (724) 284-3738, Fax: (724) 284-1310, Http://www.iqconsulting.com, Email: iqctep@zoominternet.net, Contact: Thomas E. Paserba.
- International Thermal Instrument Corporation**, P.O. Box 309, Del Mar, CA 92014; Phone: (858) 755-4436, Fax: (858) 755-6878, Http://www.iticompany.com, Email: INFO@ITICOMPANY.COM, Contact: N.D. Greene.
- Intertest, Inc.**, 303 Route 94, Columbia, NJ 07832; Phone: (908) 496-8008, Fax: (908) 496-8004, Http://www.intertest.com, Email: sales@intertest.com, Contact: Thomas F Daly.
- Ionex Research Corp.**, P.O. Box 70, 1301 Eastwind Dr., Lafayette, CO 80026; Phone: 303/666-5550, Fax: 303/666-5560, Http://www.ionexres.com, Email: dporrey@ionexres.com, Contact: Douglas W. Porrey.
- J&R Engineering Company, Inc.**, 538 Oakland Ave., P.O. Box 447, Mukwonago, WI 53149; Phone: (262) 363-9660, Fax: (262) 363-9620, Http://www.jrengco.com, Email: info@jrengco.com, Contact: John McMahon.
- J.P. Nissen Company**, 2544 Fairhill Ave., P.O. Box 339, Glenside, PA 19038; Phone: (215) 886-2025, Fax: (215) 886-0707, Http://www.nissenmarkers.com, Email: sales@nissenmarkers.com, Contact: Robert Pali.
- Jordan Nuclear Company**, 3224 Arroyo Seco Avenue, Los Angeles, CA 90065; Phone: 323/222-8141, Fax: 323/222-8144, Http://www.jordanuclear.com, Email: eam@jn.com, Contact: E. A. Manughian.
- **Joseph Oat Corporation**, 2500 Broadway, Camden, NJ 08104; Phone: (856) 541-2900 x205, Fax: (856) 541-0864, Http://www.josephoat.com, Email: mcdonaldj@josephoat.com, Contact: John McDonald. (See advertisement on page 41)
- JRM Chemical, Inc.**, 4881 Neo Pkwy., Cleveland, OH 44128; Phone: (800) 962-4010, Fax: (216) 475-6517, Http://www.soilmoist.com, Email: jrm@en.com, Contact: David Czehut.
- § **Kinectrics Incorporated**, 800 Kipling Avenue, Toronto, Ontario, M8Z 6C4 Canada; Phone: (416) 207-6000, Fax: (416) 207-6532, Http://www.kinectrics.com, Email: cheryl.tasker-shaw@kinectrics.com, Contact: Cheryl Tasker-Shaw. (See advertisement on page 51) (See corporate capabilities on page 96)
- L.A. Grime and Associates, Inc. AcroServices**, 860 Sandalwood Rd. W, Perrysburg, OH 43551-3225; Phone: (419) 872-9999, Fax: (419) 872-5588, Http://www.acroservices.com, Email: lg@acroservices.com, Contact: Larry A. Grime.
- § **Laboratory Services**, 135 W. Trail St., Jackson, MI 49201; Phone: (800) 736-4147, Fax: (517) 788-1104, Http://www.laboratoryservices.com, Email: naserafin@cmsenergy.com, Contact: Nick Serafin. (See corporate capabilities on page 96)
- LANCS Industries, Inc.**, 12704 NE 124th St., #36, Kirkland, WA 98034; Phone: (425) 823-6634, Fax: (425) 820-6784, Http://www.lancsindustries.com, Email: sales@lancsindustries.com, Contact: Timothy West, Graham Hollingsworth.
- LEMO SA**, P.O. Box 194, Chemin des Champs-Courbes 28, CH-1024 Ecublens, Switzerland; Phone: 41 21 695 16 00, Fax: 41 21 695 16 01, Http://www.lemo.com, Email: rmoreillon@lemo.com, Contact: Rene Moreillon.
- § **Lights, Camera, Action LLC**, 806 W. Impala Circle, Mesa, AZ 85210-5996; Phone: (480) 345-0642, Fax: (480) 345-0644, Http://www.lights-camera-action.net, Email: sales@lights-camera-action.net, Contact: Walt Ahland. (See corporate capabilities on page 96)
- Linn High Therm GmbH**, Heinrich-Hertz-Platz 1, 92275 Eschen Pelden, Germany; Phone: 49966591400, Fax: 4996651720, Http://www.linn.de, Email: info@linn.de, Contact: Horst Linn.
- Lista International Corp.**, 106 Lowland St., Holliston, MA 01746; Phone: 800-722-3020, Fax: 508/626-0353, Http://www.listaintl.com, Email: sales@listaintl.com, Contact: Anne Smagorinsky.
- § **LND, Inc.**, 3230 Lawson Blvd., Oceanside, NY 11572; Phone: (516) 678-6141, Fax: (516) 678-6704, Http://www.lndinc.com, Email: info@lndinc.com, Contact: William Lehnert. (See advertisement on page 61) (See corporate capabilities on page 97)
- Logic Beach Inc.**, 8363-6F Center Dr., La Mesa, CA 91942; Phone: (619) 698-3300, X206, Fax: (619) 469-8604, Http://www.logicbeach.com, Email: loggers@logicbeach.com, Contact: Dave Parks.
- **Ludlum Measurements, Inc.**, 501 Oak St., P.O. Box 810, Sweetwater, TX 79556; Phone: (800) 622-0828x3352, Fax: (325) 235-4672, Http://www.ludlums.com, Email: mtruitt@ludlums.com, Contact: Mick Truitt. (See advertisement on page 61)
- Lytron**, 55 Dragon Ct., Woburn, MA 01801; Phone: 781/933-7300, Fax: 781/935-4529, Http://www.lytron.com, Email: info@lytron.com, Contact: Tracey Barber.
- Magnatech Limited Partnership**, 6 Kripes Rd., P.O. Box 260, East Granby, CT 06026-0260; Phone: (860) 653-2573, Fax: (860) 653-0486, Http://www.magnatech-lp.com, Email: info@magnatech-lp.com, Contact: John Emmerson.
- Major Tool & Machine, Inc.**, 1458 E. 19th Street, Indianapolis, IN 46218; Phone: (317) 636-6433, Fax: (317) 634-9420, Http://www.majortool.com, Email: jamanship@majortool.com, Contact: Joel A. Manship.
- Mass Spec Services**, 103 S. Greenbush Road, Orangeburg, NY 10962; Phone: (845) 359-1151, Fax: (845) 359-1102, Email: georock150@aol.com, Contact: Keith Noyes.
- McNichols Company**, P.O. Box 30300, Tampa, FL 33630-3300; Phone: (800) 237-3820, Fax: (813) 282-8620, Http://www.mcnichols.com, Email: sales@mcnichols.com, Contact: Sharon Robertson.
- MDS Nordion**, 535 Cartier Ouest, Laval, Quebec H7V 3S8, P.Q. Canada; Phone: (450) 687-5165, Fax: (450) 687-5792, Http://www.cic.nordion.com, Email: yves.doyle@mdsinc.com, Contact: Yves Doyle.
- § **Meggitt Safety Systems**, 1915 Voyager Avenue, Simi Valley, CA 93063; Phone: 805-584-4100X8154, Fax: 805-584-9157, Http://www.meggittsafety.com, Email: alex.luterstein@meggitt.com, Contact: Alex M. Luterstein. (See advertisement on page 20) (See corporate capabilities on page 97)
- Millennium Services, Inc.**, 222 Creekstone Rdg., Woodstock, GA 30188; Phone: 770/516-7669, Fax: 770/516-7699, Http://www.millenniumservicesinc.com, Email: rjtsi@msn.com, Contact: Richard J. Titolo.

Minuteman International, Inc., 14 N 845 US RT 20, Pingree Grove, IL 60140; Phone: (630) 627-6900, Fax: (630) 627-1130, [Http://www.minutemanintl.com](http://www.minutemanintl.com), Email: info@minutemanintl.com, Contact: Ed Hribar.

- § **Mirion Technologies**, Bishop Ranch 8, 3000 Executive Parkway Suite 220, San Ramon, CA 94583; Phone: (925) 543-0800, [Http://www.mirion.com](http://www.mirion.com), Email: info@mirion.com, Contact: Kimberly Croxson. (See advertisement on page 17) (See corporate capabilities on page 97)

Modern Equipment Company, Inc., 6161 Abbott Drive, Omaha, NE 68110; Phone: (800) 228-7334, Fax: (800) 245-6078, [Http://www.meco-omaha.com](http://www.meco-omaha.com), Email: sales@meco-omaha.com, Contact: Lynn Woleben.

- **Mohawk Industrial & Nuclear Supply, Inc.**, 5 Glen Road, Manchester, CT 06040; Phone: (860) 643-5107, Fax: (860) 646-6209, [Http://www.mohawksafety.com](http://www.mohawksafety.com), Email: sales@mohawksafety.com, Contact: Jim Francoline. (See advertisement on page 47)

Morris Material Handling (P&H), 126 Powerline Road, Boyertown, PA 19512; Phone: (610) 368-8389, Fax: (610) 689-4810, [Http://www.morriscranes.com](http://www.morriscranes.com), Email: dschaeffer@morriscranes.com, Contact: David Schaeffer.

- § **MOTA Corporation**, 3410 Sunset Blvd., West Columbia, SC 29169; Phone: (803) 794-1449, Fax: (803) 939-1083, [Http://www.motacorp.com](http://www.motacorp.com), Email: sgarner@motacorp.com, Contact: Steve Garner. (See corporate capabilities on page 97)

- § **Mott Corporation**, 84 Spring Ln., Farmington, CT 06032-3159; Phone: (860) 747-6333, Fax: (860) 747-6739, [Http://www.mottcorp.com](http://www.mottcorp.com), Email: QUEST@mottcorp.com, Contact: Patty Dillon. (See corporate capabilities on page 98)

MPW Industrial Services, Inc., 9711 Lancaster Rd. SE, Hebron, OH 43025; Phone: (800) 927-8790, Fax: (740) 928-8033, [Http://www.mpwservices.com](http://www.mpwservices.com), Email: jcihow@mpwservices.com, Contact: John Cihon.

Murray and Trettel, Inc., 600 First Bank Drive, Palatine, IL 60067; Phone: (847) 963-9000, X130, Fax: (847) 963-0199, [Http://www.weathercommand.com](http://www.weathercommand.com), Email: mark.carroll@weathercommand.com, Contact: Mark Carroll.

National Inspection & Consultants, Inc., 9911 Bavaria Rd., Fort Myers, FL 33913; Phone: (239) 939-4313, Fax: (239) 334-8777, [Http://www.nicinc.com](http://www.nicinc.com), Email: dave.vigne@nicinc.com, Contact: David Vigne.

Newage Industries, Inc., 145 James Way, Southampton, PA 18966; Phone: (215) 526-2300, Fax: (215) 526-2190, [Http://www.newageindustries.com](http://www.newageindustries.com), Email: info@newageindustries.com, Contact: Sales Team.

Newark Wire Cloth Company, 160 Fornelius Ave., Clifton, NJ 07013; Phone: (973) 778-4478, Fax: (973) 778-4481, [Http://www.newarkwire.com](http://www.newarkwire.com), Email: rcampbell@newarkwire.com, Contact: Richard W. Campbell.

Nexarc Inc., 2606 B Shor Rd., Millville, PA 17846; Phone: 570/458-6990, Fax: 470/458-4980, [Http://www.nexarc.us](http://www.nexarc.us), Email: rlaubach@nexarc.us, Contact: Rick Laubach.

Niagara Fasteners Inc., 6095 Progress St., Niagara Falls L2E 6S8, Ontario Canada; Phone: (800) 263-3602, Fax: (905) 356-5747, [Http://www.niagarafasteners.com](http://www.niagarafasteners.com), Email: tnéal@niagara.com, Contact: Ted Neal.

Norman N. Axelrod Associates Optical Sensing & Control System Development Division, 121 W. 27th St., New York, NY 10001; Phone: (212) 741-6302, Fax: Upon Request, [Http://www.axelrodassociates.com](http://www.axelrodassociates.com), Email: naxelrod@axelrodassociates.com, Contact: Dr. Norman Axelrod.

Northeast Technology Corp., P.O. Box 4178, 108 N. Front St., Kingston, NY 12401; Phone: (845) 331-8511, Fax: (845) 331-8521, Email: klindquist@netcony.com, Contact: Kenneth Lindquist.

- **NPTS, Inc.**, 2060 Sheridan Dr., Buffalo, NY 14223-1470; Phone: (716) 876-8066, Fax: (716) 876-8004, [Http://www.npts.net](http://www.npts.net), Email: npts@eiteam.com, Contact: Hormoz Mansouri. (See advertisement on page 78)

NSSI/Recovery Services Inc., P.O. Box 34042, Houston, TX 77234; Phone: (713) 641-0391, Fax: (713) 641-6153, [Http://www.nssihouston.com](http://www.nssihouston.com), Email: rdgallagher@nssihouston.com, Contact: Robert Gallagher.

- **Nuclear Logistics, Inc.**, 7450 Whitehall St., Fort Worth, TX 76118; Phone: 978/250-1684 800/448-4124, Fax: (978) 250-0245, [Http://www.nuclearlogistics.com](http://www.nuclearlogistics.com), Email: cirish@nuclearlogistics.com, Contact: Craig Irish. (See advertisement on page 23)

- § **Nuclear Shielding Supplies & Service, Inc.**, 4620 S. Coach Dr., Tucson, AZ 85714-1942; Phone: (520) 917-0661 x22, Fax: (520) 917-0664, [Http://www.nuclearshielding.com](http://www.nuclearshielding.com), Email: info@nuclearshielding.com, Contact: Jordy Ensio. (See corporate capabilities on page 98)

- § **NUCON International, Inc.**, 7000 Huntley Rd., Columbus, OH 43229; Phone: (614) 846-5710, X115, Fax: (614) 431-0858, [Http://www.nucon-int.com](http://www.nucon-int.com), Email: curt.graves@nucon-int.com, Contact: Curtis Graves. (See advertisement on page 49) (See corporate capabilities on page 98)

Nutherm International, Inc., 501 South Eleventh Street, Mount Vernon, IL 62864-4834; Phone: (618) 244-6000, Fax: (618) 244-6641, [Http://www.nutherm.com](http://www.nutherm.com), Email: sales@nutherm.com, Contact: Stan Stack.

- § **O'Donnell Consulting Engineers, Inc.**, 2940 South Park Rd., Bethel Park, PA 15102; Phone: (412) 835-5007, Fax: (412) 835-5017, [Http://www.odonnellconsulting.com](http://www.odonnellconsulting.com), Email: wo@odonnellconsulting.com, Contact: Bill O'Donnell. (See corporate capabilities on page 98)

OECD Nuclear Energy Agency (NEA), 12 Blvd. des Iles, Issy-les-Moulineaux 92130, France; Phone: 33 1 45 24 10 12, Fax: 33 1 45 24 11 10, [Http://www.nea.fr](http://www.nea.fr), Email: cynthia.gannon-picot@oecd.org, Contact: Cynthia Gannon-Picot.

ORTEC, 801 S. Illinois Ave., Oak Ridge, TN 37831-0895; Phone: (800) 251-9750, Fax: (865) 483-0396, [Http://www.ortec-online.com](http://www.ortec-online.com), Email: info@ortec-online.com, Contact: Susie Brockman.

Overhoff Technology Corporation, 1160 US Highway 50, Milford, OH 45150-9705; Phone: (513) 248-2400, Fax: (513) 248-2402, [Http://www.overhoff.com](http://www.overhoff.com), Email: sales@overhoff.com, Contact: Vonise Shoemaker.

Pace Transducer Company/C.J. Enterprises, P.O. Box 570430, Tarzana, CA 91357; Phone: (818) 996-4131, Fax: (818) 708-8473, Email: cjinstruments@aol.com, Contact: Marshall Cantor.

Pacific Radiation Corporation, 2945 Stonehill Dr., Altadena, CA 91001; Phone: (626) 798-8100, Fax: (626) 798-8100, [Http://www.pacificrad.com](http://www.pacificrad.com), Email: dr_dan@pacificrad.com, Contact: Dan Gollnick.

- § **Pawling Engineered Products**, 157 Charles Colman Blvd., Pawling, NY 12564; Phone: (845) 855-1000, Fax: (845) 855-1139, [Http://www.pawling.com](http://www.pawling.com), Email: cbusby@pawling.com, Contact: Craig Busby. (See advertisement on page 76) (See corporate capabilities on page 98)

- § **Penn Iron Works, Inc.**, 700 Old Fritztown Rd., P.O. Box 6858, Wyomissing, PA 19610-6858; Phone: (610) 777-7656 x212, Fax: (610) 777-2327, [Http://www.penniron.com](http://www.penniron.com), Email: sphilippides@penniron.com, Contact: S.A. Philippides. (See corporate capabilities on page 98)

Pentek Decontamination Products DIV., 1026 4th Ave., Coraopolis, PA 15108; Phone: (412) 262-0725, Fax: (412) 262-0731, [Http://www.pentekusa.com](http://www.pentekusa.com), Email: pentekusa@aol.com, Contact: Tim Benedict.

- **Performance Contracting Inc. (PCI)**, 16047 W. 110th St., Lenexa, KS 66219; Phone: (913) 928-2800, Fax: (913) 307-0453, [Http://www.pcg.com](http://www.pcg.com), Email: jim.bleigh@pcg.com, Contact: James Bleigh. (See advertisement on page 80)

Philip C. Wagner, P.E., 4902 Dufferin St., Arlington, TX 76016; Phone: (817) 483-5565, Fax: (817) 483-5565, Email: pcwagner@yahoo.com, Contact: Philip Wagner.

Plastocor, Inc., P.O. Box 886, McMurray, PA 15317; Phone: (724) 942-0582, Fax: (724) 942-0583, [Http://www.plastocor.com](http://www.plastocor.com), Email: jemplastocor@aol.com, Contact: Jim Mitchell.

Platts UDI, 1200 G St., N. W., Suite 1000, Washington, DC 20005; Phone: 202/942-8788, Fax: 202/942-8789, [Http://www.udi-data.com](http://www.udi-data.com), Email: udi@platts.com, Contact: Christopher Bergesen.

- § **Power House Tool, Inc.**, 626 Nicholson Street, Joliet, IL 60435; Phone: (815) 727-6301, Fax: (815) 727-4835, [Http://www.powerhousetool.com](http://www.powerhousetool.com), Email: lpatterson@powerhousetool.com, Contact: Laura Patterson. (See advertisement on page 16) (See corporate capabilities on page 98)

Powerfect, 1133 D Industrial Pkwy., Brick, NJ 08724-2582; Phone: (732) 202-1133, Fax: (732) 202-1556, [Http://www.powerfect.com](http://www.powerfect.com), Email: powerfect@verizon.net, Contact: Mary Jane Luddy.

- § **PPS Access Screening**, P.O. Box 189, Arden, NC 28704; Phone: (828) 684-5960, Fax: (828) 684-2553, Email: pps@ppsaccessscreening.com, Contact: Cynthia Miller. (See corporate capabilities on page 98)

- § **Precision Custom Components, LLC**, 300 Lincoln St., York, PA 17404; Phone: (717) 848-1126, X2362, Fax: (717) 843-5733, [Http://www.pcc-york.com](http://www.pcc-york.com), Email: jstouch@pcc-york.com, Contact: James C. Stouch. (See corporate capabilities on page 98)
- § **Proto-Power Corporation**, 15 Thames St., Groton, CT 06340; Phone: 860-446-8292, Fax: 860-405-3054, [Http://www.protopower.com](http://www.protopower.com), Email: ApicelliL@zhi.com, Contact: Lisa Apicelli. (See advertisement on page 26) (See corporate capabilities on page 99)
- § **PTP Spent Fuel Services, LLC.**, P.O. Box 553, Grand Island, NY 14072; Phone: (866) 699-5515, Fax: (716) 773-5515, [Http://www.ptpsfs.com](http://www.ptpsfs.com), Email: PTP@ptpsfs.com, Contact: Bill Schaab. (See corporate capabilities on page 99)
- Quality Inspection Services, Inc.**, 37 Franklin Street Suite 400, Buffalo, NY 14202; Phone: (716) 853-2611, Fax: (716) 853-2619, [Http://WWW.QISI.COM](http://WWW.QISI.COM), Email: LJACOBS@QISI.COM, Contact: Lori Jacobs.
- Quanta Laboratories**, 3199 De La Cruz Blve., Santa Clara, CA 95054; Phone: 408/988-0770, Fax: 408/988-0762, [Http://www.quantalabs.com](http://www.quantalabs.com), Email: rgardiner@quantalabs.com, Contact: Robin Gardiner.
- R&G Laboratories, Inc.**, 217 Hobbs Street, suite 105, Tampa, FL 33619; Phone: (813) 643-3513, Fax: (813) 793-4429, [Http://www.randglabs.com](http://www.randglabs.com), Email: info@randglabs.com, Contact: Cheryl Huff.
- § **R. Brooks Associates, Inc.**, 6546 Pound Rd., Williamson, NY 14589; Phone: (315) 589-4000, Fax: (315) 589-4089, [Http://www.rbrooks.com](http://www.rbrooks.com), Email: baweir@rbrooks.com, Contact: Bruce Weir. (See corporate capabilities on page 99)
- Radiation Safety Institute of Canada**, 1120 Finch Ave. W, Ste. 607, Toronto M3J 3H7, Ontario Canada; Phone: (416) 650-9090, Fax: (416) 650-9920, [Http://www.radiationsafety.ca](http://www.radiationsafety.ca), Email: tdegeus@radiationsafety.ca, Contact: Tina de Geus.
- § **RCM Technologies, Inc.**, 2500 McClellan Avenue, Pennsauken, NJ 08109; Phone: (856) 317-0200, x113, Fax: (856) 486-0802, [Http://www.rcmt.com](http://www.rcmt.com), Email: rich.timer@rcmt.com, Contact: Richard Timer. (See corporate capabilities on page 99)
- RDF Corporation**, 23 Elm Avenue, P.O. Box 490, Hudson, NH 03051-0490; Phone: (603) 882-5195, Fax: (603) 882-6925, [Http://www.rdfcorp.com](http://www.rdfcorp.com), Email: gauthier@rdf-corp.com, Contact: Randal Gauthier.
- § **Reef Industries, Inc.**, 9209 Alameda Genoa, Houston, TX 77075; Phone: (800) 231-6074, Fax: (713) 507-4387, [Http://www.reefindustries.com](http://www.reefindustries.com), Email: tscarborough@reefindustries.com, Contact: Tom Scarborough. (See corporate capabilities on page 99)
- Relcon Scandpower AB**, Englundavagen 13 Box 1288, Sundbyberg SE-172 25, Sweden; Phone: 46 8 4452100, Fax: 46 8 4452101, [Http://www.relconscandpower.com](http://www.relconscandpower.com), Email: jerzy.grynblat@relconscandpower.com, Contact: Jerzy Grynblat.
- Research Software Consulting Group, Inc.**, 9 Irene Court, River Edge, NJ 07661-1115; Phone: (201) 262-3620, Fax: (201) 786-9128, Email: harlan.hurwitz@rscg.com, Contact: Harlan A. Hurwitz.
- Resintech, Inc.**, 160 Cooper Road, West Berlin, NJ 08091; Phone: (760) 809-4864, Fax: (856) 768-9601, [Http://www.resintech.com](http://www.resintech.com), Email: fdesilva@resintech.com, Contact: Frank DeSilva.
- § **Rigging International**, 1210 Marina Village Pkwy., P.O. Box 1285, Alameda, CA 94501; Phone: (510) 865-2400, Fax: (510) 865-9450, [Http://www.rigginginternational.com](http://www.rigginginternational.com), Email: info@rigginginternational.com, Contact: Shayrun Ali. (See corporate capabilities on page 100)
- RMD Instrument Corp.**, 44 Hunt Street, Watertown, MA 02472; Phone: (617) 668-6900, Fax: (617) 926-9743, [Http://www.rmdinc.com](http://www.rmdinc.com), Email: PWaer@rmdinc.com, Contact: Peter Waer.
- Rockbestos-Surprenant Cable Corporation**, 20 Bradley Park Rd., East Granby, CT 06026; Phone: (860) 653-8300, Fax: 800/327-7625, [Http://www.r-scc.com](http://www.r-scc.com), Email: steve-sandberg@r-scc.com, Contact: Steve Sandberg.
- Rockwell Collins Rollmet**, 1822 Deere Ave, Irvine, CA 92606; Phone: (949) 221-5329, Fax: (949) 221-5909, [Http://www.rockwell-collins.com](http://www.rockwell-collins.com), Email: mjdosdou@rockwellcollins.com, Contact: Michael Dossdourian.
- RTC Associates, Inc.**, 41 Grove St., New Milford, CT 06776; Phone: (860) 354-0078, Fax: (860) 350-8957, [Http://www rtcassociates.com](http://www rtcassociates.com), Email: info@rtcassociates.com, Contact: Robin Holick.
- RTCA-Radon Testing Corp. of America**, 2 Hayes St., Elmsford, NY 10523; Phone: (800) 457-2366, Fax: 914/345-8546, [Http://www.rtca.com](http://www.rtca.com), Email: info@rtca.com, Contact: Nancy Bredhoff.
- S&G Enterprises, Inc.**, N115 W19000 Edison Dr., Germantown, WI 53022; Phone: (262) 251-8300, Fax: (262) 251-1616, [Http://www.ramflat.com](http://www.ramflat.com), Email: ola@ramflat.com, Contact: O. C. Tyshynsky.
- S.E. International, Inc.**, 436 Farm Rd., P.O. Box 39, Summertown, TN 38483-0039; Phone: (931) 964-3561, Fax: (931) 964-3564, [Http://www.seintl.com](http://www.seintl.com), Email: radiationinfo@seintl.com, Contact: Beth Cramer.
- S.E. Logan and Associates, Inc.**, 150 Estrada Redonda, Santa Fe, NM 87506; Phone: (505) 988-2407, Fax: (505) 983-8119, Email: selogan@rt66.com, Contact: Stanley Logan.
- S.M. Stoller Corp.**, 105 Technology Drive, Suite 190, Broomfield, CO 80021; Phone: 303/546-4300, Fax: 303/443-1408, [Http://www.stoller.com](http://www.stoller.com), Email: eolson@stoller.com, Contact: Eric Olson.
- Saint-Gobain Crystals (SGC01)**, 1655 Townhurst Dr., Ste. 190, Houston, TX 77043; Phone: (713) 973-9461, Fax: (713) 973-6302, [Http://www.detectors.saint-gobain.com](http://www.detectors.saint-gobain.com), Email: scintillation@saint-gobain.com, Contact: Daniel Meldrum.
- Saint-Gobain Crystals**, 17900 Great Lakes Parkway, Hiram, OH 44234; Phone: (440) 834-5600, Fax: (440) 834-7680, [Http://www.detectors.saint-gobain.com](http://www.detectors.saint-gobain.com), Email: scintillation@saint-gobain.com, Contact: Kim Blackmon.
- § **Sargent & Lundy**, 55 E. Monroe St., Chicago, IL 60603; Phone: (312) 269-2000, Fax: (312) 269-3680, [Http://www.sargentlundy.com](http://www.sargentlundy.com), Email: thinkingpower@sargentlundy.com, Contact: Bob Schuetz. (See corporate capabilities on page 100)
- **Schulz Electric Company**, 30 Gando Dr., New Haven, CT 06513; Phone: (203) 562-5811, Fax: (203) 562-1082, [Http://www.schulzelectric.com](http://www.schulzelectric.com), Email: matt@schulzelectric.com, Contact: Matt Radulski. (See advertisement on page 62)
- § **Scientech**, 6110 Fieldcrest Drive, Frederick, MD 21701; Phone: (301) 668-1033, Fax: (301) 682-9209, [Http://www.scientech.com](http://www.scientech.com), Email: dmurphy@scientech.com, Contact: Donald Murphy. (See corporate capabilities on page 100)
- **Seal Master Corporation**, 368 Martinel Dr., Kent, OH 44240; Phone: (800) 477-8436, Fax: (330) 673-8242, [Http://www.sealmaster.com](http://www.sealmaster.com), Email: info@sealmaster.com, Contact: Thomas Hillery. (See advertisement on page 75)
- Serapid**, 5400 18 Mile Road, Sterling Heights, MI 48314; Phone: (586) 274-0774, Fax: (586) 274-0775, [Http://www.serapid.com](http://www.serapid.com), Email: info-us@serapid.com, Contact: Ann Marie Fortunate.
- Serdula Systems Ltd.**, 2 Forest Ave., P.O. Box 1808, Deep River K0J 1P0, Ontario Canada; Phone: (613) 584-4588, Fax: (613) 584-2690, Email: kserdula@magma.ca, Contact: Kenneth J. Serdula.
- **Siemens Energy, Inc.**, 4400 Alafaya Trail, Q1-249, Orlando, FL 32826-2399; Phone: (407) 736-5791, Fax: (407) 736-5645, [Http://www.siemens.com/energy](http://www.siemens.com/energy), Email: dawn.mccarter@siemens.com, Contact: Dawn McCarter. (See advertisement on page 53)
- SKODA JS a.s.**, Orlik 266, 316 06 Plzen, Czech Republic; Phone: 420 378 042 410, Fax: 420 377 520 600, [Http://www.skoda.js.cz](http://www.skoda.js.cz), Email: josef.riha@skoda.js.cz, Contact: Josef Riha.
- SOLTEC Corporation**, 12977 Arroyo St., San Fernando, CA 91340-1548; Phone: (818) 365-0800, X350, Fax: (818) 365-7839, [Http://www.solteccorp.com](http://www.solteccorp.com), Email: ranick@solteccorp.com, Contact: Melissa Ranick.
- § **Sonic Systems International, Inc.**, 1880 Dairy Ashford, Ste. 207, Houston, TX 77077; Phone: (281) 531-7611 ext.15, Fax: (281) 531-7595, [Http://www.ssi-group.net](http://www.ssi-group.net), Email: ganderson@ssi-group.net, Contact: Gregg Anderson. (See corporate capabilities on page 102)
- § **Southern Testing Services a Division of ATC**, 10627 Lexington Drive, Knoxville, TN 37932; Phone: (865) 966-5330, Fax: (865) 675-5399, [Http://www.argoturbo.com](http://www.argoturbo.com), Email: southernesting@argoturbo.com, Contact: Rich Crawford. (See corporate capabilities on page 102)
- Spectra Physics Hilger Crystals Limited**, Westwood Estate, Margate, Kent CT9 4JL, United Kingdom; Phone: 441843 231166, Fax: 441843 290310, [Http://www.hilger-crystals.co.uk](http://www.hilger-crystals.co.uk), Email: sales@hilger-crystals.co.uk, Contact: J. R. Telfer.
- § **Spectrum Technologies a Division of ATC**, 112 Erie Boulevard, Schenectady, NY 12305; Phone: (518) 382-0056, Fax: (518) 382-0283, [Http://www.argoturbo.com](http://www.argoturbo.com), Email: spectrum@argoturbo.com, Contact: George Kuhn. (See corporate capabilities on page 102)

- § **SSM Industries, Inc.**, 3401 Grand Ave., Pittsburgh, PA 15225-1507; Phone: (412) 777-5101 X-363, Fax: (412) 771-5382, [Http://www.ssiworld.com](http://www.ssiworld.com), Email: m.saucier@ssmi.biz, Contact: Mark Saucier. (See advertisement on page 32) (See corporate capabilities on page 102)
Stacosystems, 1139 Baker St., Costa Mesa, CA 92626; Phone: (714) 549-3041, X270, Fax: (714) 549-0930, [Http://www.stacosystems.com](http://www.stacosystems.com), Email: mmccann@stacosystems.com, Contact: Michelle McCann.
- **Staplex-Air Sampler Division**, 777 5th Ave., Brooklyn, NY 11232-1626; Phone: (800) 221-0822, Fax: (718) 965-0750, [Http://www.staplex.com](http://www.staplex.com), Email: info@staplex.com, Contact: Doug Butler.
- § **Staubli Corporation**, 201 Parkway West, Duncan, SC 29334; Phone: (864) 433-1980, Fax: (864) 486-5498, [Http://www.staubli.com](http://www.staubli.com), Email: a.brake@staubli.com, Contact: Andreas Brake. (See corporate capabilities on page 102)
- **STN Service Center Europe, FIZ** Karlsruhe, D-76012 Karlsruhe, Germany; Phone: 49 7247 808 555, Fax: 49 7247 808 131, [Http://www.fiz-karlsruhe.de](http://www.fiz-karlsruhe.de), Email: helpdesk@fiz-karlsruhe.de, Contact: R. Mack.
- **Stork H&E Turbo Blading**, 334 Comfort Rd., Ithaca, NY 14850; Phone: 607/277-4968 x292, Fax: 607/277-1193, [Http://www.he-machinery.com](http://www.he-machinery.com), Email: joe.walker@storkhe.com, Contact: Joe Walker.
- § **Studsvik, Inc.**, 5605 Glenridge Dr., NE, Suite 705, Atlanta, GA 30342; Phone: (404) 497-4910, Fax: (404) 497-4901, [Http://www.studsvik.com](http://www.studsvik.com), Email: tom.duberville@studsvik.com, Contact: Tom Duberville. (See advertisement on page 73) (See corporate capabilities on page 102)
- **Suncoast Solutions, Inc.**, 1348 New Forest Ln., Osprey, FL 34229; Phone: (941) 423-0323, Fax: (941) 423-0323, [Http://www.suncoastsolutions.org](http://www.suncoastsolutions.org), Email: suncoastsolutions@comcast.net, Contact: Paul Saunders.
- **Supersaturated Environments (Div. of Reflection Imaging, Inc.)**, P.O. Box 55252, Madison, WI 53705; Phone: (608) 238-5068, Fax: (608) 238-5080, [Http://www.cloudchambers.com](http://www.cloudchambers.com), Email: sales@cloudchambers.com, Contact: Jeffrey Radtke.
- § **T. D. Williamson, Inc.**, 565 Anderson Dr., Unit A, Romeoville, IL 60446; Phone: (800) 828-1988, Fax: (815) 407-0675, [Http://www.tdwilliamson.com](http://www.tdwilliamson.com), Email: gary.bucholz@tdwilliamson.com, Contact: Gary Bucholz. (See corporate capabilities on page 102)
- § **Talisman International, LLC**, 1000 Potomac St. NW, Ste. 300, Washington, DC 20007; Phone: (202) 471-4244, Fax: (202) 471-4360, [Http://www.talisman-intl.com](http://www.talisman-intl.com), Email: hthompson@talisman-intl.com, Contact: Hugh Thompson. (See corporate capabilities on page 103)
- **TECH Products, Inc.**, 105 Willow Ave., Staten Island, NY 10305; Phone: 718/442-4900, Fax: 718/442-2124, Email: doconnor@techproducts.com, Contact: Daniel D O'Connor.
- **TechniDATA AG**, Munich Branch Office, Hans-Pinsel-Str.4, 85540 Haar, Germany; Phone: 49 89 456657 0, Fax: 49 89 456657 820, [Http://www.technidata.de](http://www.technidata.de), Email: Claus.Holzheimer@technidata.de, Contact: Claus Holzheimer.
- **Technisonic Research Inc.**, 301 Commerce Dr., Fairfield, CT 06825; Phone: (203) 368-3600, Fax: (203) 368-1922, [Http://www.technisonicinc.com](http://www.technisonicinc.com), Email: tr.tri@sbcglobal.net, Contact: Tony Ruiz.
- **Technology for Energy Corporation (TEC)**, 10737 Lexington Dr., Knoxville, TN 37932-3294; Phone: (865) 966-5856, Fax: (865) 675-1241, [Http://www.tecnuclear.com](http://www.tecnuclear.com), Email: sales@tecnuclear.com, Contact: Sharon Partin. (See advertisement on page 54)
- § **Tecnatom, S.A.**, Avenue Montes de Oca 1, 28709 San Sebastian de los Reyes, Madrid Spain; Phone: 34 91 6598600, Fax: 34 91 6598677, [Http://www.tecnatom.es](http://www.tecnatom.es), Email: correo@tecnatom.es, Contact: Juan Ortega. (See advertisement on page 77) (See corporate capabilities on page 103)
- **Temp-Pro Inc.**, 200 Industrial Dr., Northhampton, MA 01060; Phone: (413) 584-3165, Fax: (413) 586-3625, [Http://www.temp-pro.com](http://www.temp-pro.com), Email: sales@temp-pro.com, Contact: Stanley T. Grip.
- § **The Delphi Groupe, Inc.**, 2211 S. IH-35, Ste. 400, Austin, TX 78741; Phone: (512) 462-1181, Fax: (512) 462-1187, [Http://www.delphigroupe.com](http://www.delphigroupe.com), Email: mrandolph@delphigroupe.com, Contact: Mark Randolph. (See corporate capabilities on page 103)
- **The M&P Lab**, 2210 Technology Dr., P.O. Box 724, Schenectady, NY 12301; Phone: (518) 382-0082, Fax: (518) 382-1182, [Http://www.the-mandp-lab.com](http://www.the-mandp-lab.com), Email: info@the-mandp-lab.com, Contact: Mary Ann Arcesi.
- **The Macris Group**, P.O. Box 535, Mystic, CT 06355; Phone: (860) 572-0043, Fax: (860) 572-0043, [Http://www.themacrisgroup.com](http://www.themacrisgroup.com), Email: acmpc@themacrisgroup.com, Contact: A.C. Macris.
- § **The Shaw Group Inc. Nuclear Power Division**, 128 S. Tryon St., Charlotte, NC 28202; Phone: (856) 482-3000, Fax: (865) 482-4028, [Http://www.shawgrp.com](http://www.shawgrp.com), Email: alan.latti@shawgrp.com, Contact: Alan W. Latti.P.E.. (See advertisement on page 29) (See corporate capabilities on page 103)
- **Thermal Engineering International**, 10375 Slusher Drive, Santa Fe Springs, CA 90670; Phone: (323) 838-1150, Fax: (323) 838-6454, [Http://www.thermalengint.com](http://www.thermalengint.com), Email: msr@thermalengint.com, Contact: Abraham Yarden.
- § **Thermo Fisher Scientific Scientific Instrument Division CIDTEC Cameras & Imagers**, 101 Commerce Blvd., Liverpool, NY 13088; Phone: (315) 451-9410, Fax: (315) 451-9421, [Http://www.thermo.com/cidtec](http://www.thermo.com/cidtec), Email: tony.chapman@thermofisher.com, Contact: Tony Chapman. (See advertisement on page 7) (See corporate capabilities on page 103)
- § **Thermo Scientific**, One Thermo Fisher Way, Oakwood Village, Ohio 44146; Phone: 440-703-1400, Fax: 440-703-1596, Email: joseph.rotunda@thermofisher.com, Contact: Joseph Rotunda. (See corporate capabilities on page 103)
- **Thermo Scientific, Niton Analyzers**, 900 Middlesex Turnpike, Bldg 8, Billerica, MA 01821; Phone: (978) 670-7460, Fax: (978) 670-7430, [Http://www.thermo.com/niton](http://www.thermo.com/niton), Email: niton@thermofisher.com, Contact: Jennifer Robert.
- § **Thermo Scientific, Part of Thermo Fisher Scientific Process Instruments Div.**, 10010 Mesa Rim Rd., San Diego, CA 92121; Phone: (800) 488-4399, Fax: (858) 452-9250, [Http://www.thermo.com/nuclear](http://www.thermo.com/nuclear), Email: ussdi.customersupport@thermofisher.com, Contact: Clark Artaud. (See corporate capabilities on page 103)
- § **Tioga Pipe Supply Company Inc.**, 2450 Wheatsheaf Ln., Philadelphia, PA 19137; Phone: (215) 831-0700, Fax: (215) 533-1645, [Http://www.tiogapipe.com](http://www.tiogapipe.com), Email: jshaw@tiogapipe.com, Contact: Jeff Shaw. (See corporate capabilities on page 103)
- **TLG Services, Inc. An Entergy Nuclear Company**, 148 New Milford Road East, Bridgewater, CT 06752; Phone: (860) 355-2300, Fax: (860) 355-2705, [Http://www.tlgservices.com](http://www.tlgservices.com), Email: adler@tlgservices.com, Contact: Joseph J. Adler.
- **TransWare Enterprises Inc.**, 1565 Mediterranean Dr., Sycamore, IL 60178-3141; Phone: (815) 895-4700, Fax: 815/895-4704, [Http://www.transware.net](http://www.transware.net), Email: vjones@TRANSWARE.NET, Contact: Virginia Jones.
- § **TRANTER**, 1900 Old Burk Hwy, Wichita Falls, TX 76307; Phone: (940) 723-7125, Fax: (940) 723-1131, [Http://www.tranter.com](http://www.tranter.com), Email: sales@tranter.com, Contact: Jody Stonecipher. (See corporate capabilities on page 103)
- **Trentec, Inc.**, 4600 E. Tech Dr., Cincinnati, OH 45245; Phone: (513) 528-7900, X130, Fax: (513) 528-9292, [Http://www.trentec.com](http://www.trentec.com), Contact: Rick Salem.
- **Tri Nuclear Corporation**, 40 Lake Rd., P.O. Box 1130, Ballston Lake, NY 12019; Phone: (518) 399-1389, Fax: (518) 399-9586, [Http://www.trinuclear.com](http://www.trinuclear.com), Email: jwarden@trinuclear.com, Contact: James Warden.
- **Tri Tool Inc.**, 3041 Sunrise Blvd., Rancho Cordova, CA 95742; Phone: (916) 288-6100, Fax: (916) 288-6160, [Http://www.tritool.com](http://www.tritool.com), Email: customer.service@tritool.com, Contact: Bill Atkinson. (See advertisement on page 65)
- **Trust Manufacturing**, 20080 St. Clair, Cleveland, OH 44117; Phone: (216) 531-8787, Fax: (216) 531-8778, [Http://www.trustmfg.com](http://www.trustmfg.com), Email: edgills@trustmfg.com, Contact: Ed Gills. (See advertisement on page 45)
- § **Underwater Construction Corporation**, 110 Plains Rd., Essex, CT 06426; Phone: (800) USA-DIVE, Fax: (860) 767-0612, [Http://www.uccdive.com](http://www.uccdive.com), Email: cvalance@uccdive.com, Contact: Charles A. Vallance. (See advertisement on page 56) (See corporate capabilities on page 104)
- § **UniStar Nuclear Energy**, 750 E. Pratt St. 14th Floor, Baltimore, MD 21202; Phone: (410) 783-2800, Fax: (410) 470-5606, [Http://www.unistarnuclear.com](http://www.unistarnuclear.com), Email: info@unistarnuclear.com, Contact: Mike McGough. (See advertisement on page 4) (See corporate capabilities on page 104)
- § **UniTech Services Group, Inc. Div. of Unifirst Corp.**, 295 Parker St., P.O. Box 51957, Springfield, MA 01151; Phone: (413) 543-6911, X16, Fax: (413) 543-2975, [Http://www.unitech.ws](http://www.unitech.ws), Email: gjohnstone@unitech.ws, Contact: Gregg Johnstone. (See advertisement on page 22, 34, 47) (See corporate capabilities on page 104)

Unitron, Ltd, 120-C Wilbur Pl., Bohemia, NY 11716-2416; Phone: (631) 589-6666, Fax: (631) 589-6975, Http://www.unitronusa.com, Email: info@unitronusa.com, Contact: John Coyle.

Universal Technical Equipment, Inc., 1100 Woodlawn Ave., Collingdale, PA 19023-8385; Phone: (610) 586-3535, Fax: (610) 586-0151, Email: unitech@integrity.com, Contact: Curt R Modes.

- **Urenco Ltd.**, 18 Oxford Rd., Marlow, Buckinghamshire SL7 2NL, UK; Phone: 44 1628 486941, Fax: 44 1628 402287, Http://www.urenco.com, Email: enquiries@urenco.com, Contact: Maurice Lenders. (See advertisement on page 43)

§ **Uticom Systems Inc.**, 109 Independence way, Coatesville, PA 19320; Phone: (610) 857-2986, Fax: (610) 857-2986, Email: jennifer@uticom.net, Contact: Jennifer Martin. (See corporate capabilities on page 104)

§ **Valcor Engineering Corporation**, 2 Lawrence Rd., Springfield, NJ 07081; Phone: (973) 467-8480 EXT 7226, Fax: (973) 467-3365, Http://www.valcor.com, Email: stevegatcomb@valcor.com, Contact: Steve Gatcomb. (See corporate capabilities on page 104)

Val-Matic Valve & Manufacturing Corporation, 905 Riverside Dr., Elmhurst, IL 60126; Phone: (630) 941-7600, Fax: (630) 941-8042, Http://www.valmatic.com, Email: ajs@valmatic.com, Contact: Alissa Schultz.

Valnerability Assessment Team Argonne National Laboratory, 9700 S. Cass Ave, Argonne, IL 60439-4840; Phone: 630-252-6168, Fax: (505) 665-4631, Email: rogerj@anl.gov, Contact: Roger Johnston.

§ **Valtimet Inc.**, 5501 Air Park Blvd., Morristown, TN 37813; Phone: 423/587-1888, Fax: 423/585-4215, Http://www.valtimet.com, Email: us.contact@valtimet.com, Contact: Wendy McGowan. (See corporate capabilities on page 104)

§ **Velan Valve Corporation**, 94 Ave. C, Griswold Industrial Park, Williston, VT 05495; Phone: (802) 864-3350, Fax: (802) 865-3030, Http://www.velan.com, Email: dbowers@velanvalve.com, Contact: Don Bowers. (See corporate capabilities on page 104)

Ventyx, 3301 Windy Ridge Pkwy., Atlanta, GA 30339; Phone: (800) 868-0497, Fax: (770) 989-4231, Http://www.ventyx.com, Email: sales@ventyx.com, Contact: Gary Frazier.

Veridiam, P.O. Box 609036, San Diego, CA 92160-9036; Phone: (619) 448-1000, Fax: (619) 562-5776, Http://www.veridiam.com, Email: rhockman@veridiam.com, Contact: Rich Hockman.

Volian Enterprises, Inc., P.O. Box 410, Murrysville, PA 15668; Phone: (724) 335-3744, Fax: (724) 337-9752, Http://www.volian.com, Email: volianenterprises@volian.com, Contact: Harold Julian.

VTT Technical Research Centre of Finland, Tietotie 3, Espoo, P.O. Box 1000, FI-02044 VTT, Finland; Phone: 358 20 722 5067, Fax: 358 20 722 5000, Http://www.vtt.fi/nuclear, Email: seppo.vuori@vtt.fi, Contact: Seppo Vuori.

Warrington, Inc., 1421 Wells Branch Pkwy., Ste. 106, Pflugerville, TX 78660; Phone: (512) 251-7771, Fax: (512) 251-7744, Http://www.warringtonusa.com, Email: stafford@warringtonusa.com, Contact: Gary Stafford.

Waste Control Systems, Inc., 2835 Merwymans Mill Rd., Phoenix, MD 21131-1631; Phone: (410) 252-9360, Fax: (410) 252-9362, Http://www.wastecontrol.com, Email: sales@wastecontrol.com, Contact: William Fannon.

Weed Instrument, 707 Jeffrey Way, P.O. Box 300, Round Rock, TX 78680; Phone: (512) 434-2950, Fax: (512) 434-2951, Http://www.weedinstrument.com, Email: nuclear@weedinstrument.com, Contact: David Robertson.

Weir Valves and Controls Formerly Atwood & Morrill Company, Inc., 285 Canal St., Salem, MA 01970; Phone: (978) 744-5690, Fax: (978) 741-3626, Http://www.weirvalve.com, Email: cgilbert@weirvalveusa.com, Contact: Christopher Gilbert.

Welding Services Inc., 2225 Skyland Court, Norcross, GA 30071; Phone: (678)728-9275, Fax: (770)449-4684, Http://www.weldingservices.com, Email: mwelch@wsi.aquilex.com, Contact: Michael A. Welch.

Weldstar Company, 1750 Mitchell Road, Aurora, IL 60505; Phone: (630)859-3100, Fax: (630)859-3199, Contact: Robert Decker.

- § **Westerman Nuclear**, 245 N. Broad St., Bremen, OH 43107; Phone: (800) 338-8265, Fax: (740) 569-4111, Http://www.westermancompanies.com, Email: jchristian@westermancompanies.com, Contact: Jim Christian. (See advertisement on page 72) (See corporate capabilities on page 105)
- § **Western Chemical International Inc.**, 2939 N 67th Place, PO Box 22267, Scottsdale, AZ 85251; Phone: (480) 990-9487, Fax: (480) 946-6174, Http://www.westernchem.com, Email: wci@westernchem.com, Contact: Gary Conley. (See advertisement on page 22) (See corporate capabilities on page 105)

Western Sling And Supply Company, 5453 North Peterson Road, Sedalia, CO 80135; Phone: (303) 688-0978, Fax: (303) 688-5905, Http://WWW.WESTERNSLING.COM, Email: BOB.TRUITT@WESTERN-SLING.COM, Contact: Bob Truitt.

Western United Industries, P.O. Box 2008, Toluca Lake, CA 91610; Phone: (818) 980-9977, Fax: (818) 980-2618, Contact: Barry Tindell.

- § **Westinghouse Electric Company**, P.O. Box 355, Pittsburgh, PA 15230; Phone: (412) 374-3373, Fax: (412) 374-3244, Http://www.westinghousenuclear.com, Email: fishch1ks@westinghouse.com, Contact: Karen Fischetti. (See advertisement on page 119) (See corporate capabilities on page 105)

WM B. Johnson & Associates Inc., 200 Aei Dr., Lewisburg, WV 24901; Phone: 304/645-6568, Fax: 304/645-2182, Http://www.johnsonnuclear.com, Email: clandfried@msn.com, Contact: Chrles Landfried.

- **WM Symposia Ste 9-332**, 1628 E Southern Ave, Suite 9-322, Tempe, AZ 85282; Phone: (520) 696-0399, Fax: (520) 829-3550, Http://www.wmsym.org, Email: mary@wmarizona.org, Contact: Mary Young. (See advertisement on page 70)

Wm. B. Johnson & Assoc., 216 Edgar Avenue, P.O. Box 472, Ronceverte, WV 24970; Phone: (304)645-6568, Fax: (304)645-2182, Contact: Dick Landfried.

§ **WMG, Inc.**, 16 Bank St., Peekskill, NY 10566; Phone: (845) 667-2507, Fax: (914) 736-7170, Http://www.wmginc.com, Email: fsennyeyes@wmginc.com, Contact: Frank Sennyeyes. (See corporate capabilities on page 105)

Worklon Uniforms, 10055 Seminole Blvd., Seminole, FL 33772-2539; Phone: (800) 298-7896, Fax: (727) 391-7514, Http://www.worklon.com, Email: pgeorge@sug.biz, Contact: Pamela George.

- **WorleyParsons Group, Inc.**, 2675 Morgantown Road, Reading, PA 19607; Phone: 610 855 2000, Fax: (610) 855-2001, Http://www.worleyparsons.com, Email: Gerald.Goldsmith@WorleyParsons.com, Contact: Gerald Goldsmith. (See advertisement on page 39)

§ **Wyle Laboratories, Inc.**, 7800 Hwy. 20 W, P.O. Box 07777, Huntsville, AL 35806; Phone: (256) 716-4315, Fax: 256/837-3363, Http://www.wylelabs.com, Email: robert.francis@wylelabs.com, Contact: Robert L. Francis. (See corporate capabilities on page 105)

- § **Zetec, Inc.**, 8226 Bracken Place SE, Suite 100, Snoqualmie, WA 98065; Phone: (425) 974-2700, Fax: (425) 974-2701, Http://www.zetec.com, Email: kchoi@zetec.com, Contact: Ki Choi. (See advertisement on page 3) (See corporate capabilities on page 106)

Zircatec Precision Industries Inc., 200 Dorset St. E, Port Hope L1A 3V4, Ontario Canada; Phone: (905) 885-4537, Fax: (905) 372-3748, Http://www.CAMECO.COM, Email: DOUG_BURTON@CAMECO.COM, Contact: Doug Burton Connie Duncan.



Striving to be a Good Neighbor

By Tyler Lamberts, Entergy Nuclear Operations, Inc.

Located five miles northwest of Port Gibson, Mississippi, Grand Gulf Nuclear Station stands out in the industry in more ways than one. Almost a fourth of Mississippi's electricity output is provided by Grand Gulf. The site is also one of the candidates for a new nuclear power plant. Faces at the plant are still glowing with excitement after an early site permit was issued by the Nuclear Regulatory Commission on March 27, 2007. Doubling nuclear capacity could have a significant impact on the electricity supply in Mississippi, and with a solid reputation as a respectable and efficient site, Grand Gulf is looking forward to a long and successful future.

It is highly unlikely that Grand Gulf would ever be considered stagnant, as advancements in technology, outage records and plans for the future keep the site in constant motion. However, the one thing that does remain constant at the site is the goal to operate the station safely and efficiently while residing on the leading edge of the nuclear renaissance.

Grand Gulf's birth came during the very throes of the energy crisis. The project was announced in January 1972, and preliminary work began immediately. After more than two years of in-depth environmental studies, construction began on a limited scale in May 1974. The following September, a full construction permit was received and building continued. After receiving an operating license in 1984 from the NRC, Grand Gulf began commercial operation in July 1985. Since then, the site has produced over 196.95 billion kilowatt-hours of electric energy. The boiling water reactor is a General Electric design and is currently authorized for commercial operation through June 2022.

Originally, the Grand Gulf location was designed to be a two unit site. However, in December 1979 construction of Grand Gulf Unit 2 was deferred in order



Tyler Lamberts

Tyler Lamberts graduated in June, 2008 with a degree in Marketing from Oregon State University. Tyler currently works for OSU Conference Services in Corvallis, Oregon



Randy Douet

Randy Douet joined Entergy's Grand Gulf Nuclear Station as Site Vice President in early March of 2008 from the Tennessee Valley Authority, where he most recently served as vice president of nuclear support and previously served as site vice president at Sequoyah Nuclear Plant.

to concentrate resources on the completion of Unit 1. After Unit 1 had received its commercial cooperating license, Entergy Operations, Inc. formally asked the NRC to revoke the construction permit and officially cancel the second unit at the Grand Gulf Nuclear Station, which the NRC did in August 1991.

Efficiency, an Ongoing Goal

In 2002, Grand Gulf started generating about 20 additional megawatts of electricity, enough to supply at least 20,000 additional homes. The increased output from the plant began June 30 when a complex auxiliary cooling tower project was completed and placed in service.

The Mississippi Public Service Commission approved the project in fall 2000. Actual construction began in summer 2001.

Modifying the original natural draft cooling tower and constructing the auxiliary tower to operate in parallel was a technically challenging feat. Grand Gulf was the first plant in the world to have

successfully accomplished this parallel operation with circulating water flow equally divided between the cooling towers.

The design of Grand Gulf's 520-foot tall, natural draft cooling tower creates airflow that cools the circulating water. The new low profile, mechanical draft auxiliary tower uses 20 huge motor-operated fans to create additional cooling airflow.

Radial Well Lateral Renovation Project

Starting in 2005, a project began at Grand Gulf to replace old laterals the radial wells to gain margin in the plant service water system. The radial wells were not delivering the design flow of water to the plant. The old carbon steel laterals in wells numbers one, three and five were collapsing and extensive operations and maintenance costs were required to clean the wells to ensure adequate water supply for the plant. Furthermore, required margin in the PSW system had been lost when the

(Continued on page 118)

Striving to be...

Continued from page 117

Mississippi River has low water levels or high water temperatures.

The laterals in well number one were replaced with stainless steel laterals in 2005 and the water supply from that well increased significantly. In 2006 the laterals in well number three were replaced with stainless steel. This update led to an increased water supply.

During 2007 well number five laterals were replaced, completing the last leg of this project. Radial well number five is now able to supply 10,000 gallons per minute of plant service water to the plant. Grand Gulf requires a nominal 25,000 gallons of water per minute to run the reactor at 100 percent capacity. With the completion of the work at well number five, the four existing wells are able to reliably supply the required water and still have sufficient capacity to allow maintenance of the plant service water pumps to be performed on-line when required.

Grand Gulf Dry Fuel Storage Project

In August 2004, Grand Gulf received project funding approval for the design and construction of an onsite independent spent fuel storage installation and for the procurement of a dry cask storage system (DCSS).

The major components of the DCSS at Grand Gulf are a multi-purpose canister which receives and confines the spent nuclear fuel, a cask (overpack) which receives a sealed MPC for interim storage on the ISFSI pad, and a transfer cask designed to transfer a loaded MPC to or from the overpack in a radiological safe manner.

An ISFSI at Grand Gulf became necessary since a relatively small amount of storage space remain in the spent fuel pool. With four casks loaded in November-December 2006 and the next campaign scheduled in March-April 2008, dry fuel storage activities in 2007 were minimal. Remote temperature monitoring for the four casks on the Independent Spent Fuel Storage Installation pad will be connected and other minor work performed to complete all modifications.

Safe and Efficient Outage Performance

Grand Gulf Nuclear Station has a tradition of strong outage performance and the site continued this practice during their 15th refueling outage in March/April 2007.

Safety performance at the station was excellent and the dose performance set a new BWR 6 outage record. There were no events that threatened nuclear safety during the outage and there were no lost time accidents; no OSHA recordable accidents; and only 10 first aids. Outage duration was 24 days, 10 hours and 42 minutes. These accomplishments are a prime example of how the staff at Grand Gulf is dedicated to safety and efficiency at the plant.

Strong Relationship with the Community

Grand Gulf Nuclear Station continually strives to be a good neighbor. Over 600 employees have a notable track record of contributing to Port Gibson and Vicksburg communities in a wide variety of community-based initiatives and programs. The goal is to continue to build a strong relationship with the surrounding communities through donations and community outreach.

Employees at Grand Gulf contributed over \$105,257 to support the United Way fundraising campaign in 2007. Combined with the dollar-for-dollar match by Entergy Corporation, the total contributed was over \$210,500. This level of giving represented 47 percent of the campaign's total.

Dedicated Grand Gulf employees connect with students and teachers through community outreach with Claiborne County Schools. Employees do this by supporting the annual community awareness night program and by participating in the business and education standing together program. Another way Grand Gulf employees support the schools is by providing guest speakers for workshops and by volunteering with the partner in education program. Employees also mentor students by tutoring them after school programs.

Grand Gulf employees are also proud to contribute to the Susan G. Komen Breast Cancer Drive and Alcorn State University's Relay for Life. In addition, employees donate their time to support groups such as Mississippi Blood Services,

Special Olympics, and Claiborne County Schools.

Unit Specific Information

- Type & manufacturer: BWR 6, General Electric Co.
- Turbine and generator manufacturer: Allis-Chalmers Power Systems, Inc.
- Cooling water source: Mississippi River via a natural draft primary cooling tower. Beginning in 2002, a forced draft auxiliary cooling tower has been used in parallel during the summer to increase efficiency and output.
- Overall Mississippi energy demand met by Grand Gulf: About 29 percent
- Environmental emissions avoided (in 2005) by operation of Grand Gulf: sulfur dioxide: 15,600 tons; nitrogen oxide: 12,800 tons; carbon dioxide: 7.9 million metric tons

Grand Gulf Nuclear Station is currently owned by System Energy Resources, a wholly-owned subsidiary of New Orleans-based Entergy Corporation, with a 10 percent minority ownership by South Mississippi Electric Power Association based in Hattiesburg, Mississippi. The site is operated by Entergy's nuclear business function. There are eight other nuclear sites with a combined ten nuclear units owned by Entergy subsidiaries and operated by Entergy Nuclear. These units are located in Arkansas (Arkansas Nuclear One, with two operating units), Louisiana (River Bend and Waterford 3), Massachusetts (Pilgrim), Michigan (Palisades), New York (Indian Point, with two operating units, and FitzPatrick) and Vermont (Vermont Yankee). Entergy Nuclear is also contracted to provide management services to Nebraska Power District's Cooper Nuclear Station in Nebraska through 2014.

Contact: Timothy Crisler, Grand Gulf Nuclear Station, G-ESCI-CC, P.O. Box 756, Port Gibson, MS.39150; telephone: (601) 437-6393, fax: (601) 437-2795, e-mail: tcrisler@entergy.com. ■

WESTINGHOUSE HAS SOME

simple ideas,

TO ACCOMPLISH

great things.

PETE SENA

Site Vice President
Beaver Valley Power Station
FENOC

DAVE BALAS

Manager of Global Outage Support
Westinghouse

JIM LASH

Senior Vice President
FENOC – Operations



WESTINGHOUSE ELECTRIC COMPANY LLC

When our Alliance Partner, FirstEnergy Nuclear Operating Company (FENOC), set a long-term goal to reduce outage dose at its Beaver Valley Power Station, they asked Westinghouse to assist.

The Westinghouse team, led by Customer 1st leader Dave Balas, worked with Pete Sena, Jim Lash and the Beaver Valley Power Station to apply Customer 1st tools. As a result, the plant achieved a 39 percent dose reduction during the fall 2007 Unit 1 outage, advancing Beaver Valley from the industry's fourth to second quartile in outage dose performance. During Beaver Valley's spring 2008 outage, results were even better as Unit 2 advanced from fourth to first quartile in outage dose performance.

Improving outage performance and applying the benefits and industry lessons learned are just a few ways that Westinghouse nuclear technology is strengthening performance at the world's leading nuclear power plants.

Check us out at www.westinghousenuclear.com

Committed to customer success.

.....
"Unit 1 achieved its lowest outage dose ever. Great teamwork and coordination were evident as Beaver Valley performed its best-ever durations for six Westinghouse outage windows."

.....
— PETE SENA
.....



Westinghouse

A Toshiba Group Company

**You can be sure...
if it's Westinghouse**

BRING IT ON



Scientech and Trentec have combined our world-class Equipment Qualification and Testing capabilities. Together, we're bigger and better.

We offer a wide variety of EQ services and recently were confirmed to meet the AP1000™ Main Steam Compartment harsh environment transient. We have seismic facilities in the midwest and southeast with over 100 standardized procedures, two LOCA facilities and over 20 test engineers.

So bring on your project...we'll latch on to it and won't let go until it's done to your satisfaction.

NO BONES ABOUT IT

Contact us at 513.528.7900 or EQ@curtisswright.com



Nuclear Group

www.cwfc.com

 SCIENTECH www.scientech.com

 TRENTEC www.trentec.com

AP1000 is a trademark of Westinghouse Electric Company, LLC